

1/8 DIN SIGNAL OR EXTERNALLY POWERED METERS (DC & AC)

NEW

*** > 40 INPUT SIGNALS * ANY COLOR LED**

MODEL

SPM

10/21/2019

FEATURES:

- **NEW!** White LED for any color filter (Red is standard).
- 4 1/2 Digits .6" LED or 3 1/2 or 4 Digits 0.8" LED
- Signal Powered For: 4-20mADC, V/mADC or AC Volts, Amps, Watts and Hertz
- 5, 10-32VDC or 90-265VAC Power
- Outputs: 4-20mA, Relays (4)
- Serial Comm.: RS232, 485, USB
- Lifetime Warranted

APPLICATIONS:

- D.C.S./SCADA
- Shipboard/Avionics
- Nuclear & Mil-Spec

DESCRIPTION:

With over 30 years in the **Digital Panel Meter** field, we had to bring you the best that technology would allow. The **SPM** is a combination of that expertise and newest technology in an industry's standard 1/8 DIN package. We started with a universal display (4 1/2 digit LED) and embedded Sigma-Delta A/D. We added a "Bussed" mother board that we can

add any of hundreds of designs from our 30+ years library to deliver the industry's only "Lifetime Warranted" Digital Panel Meter. Whether for Systems or just to monitor, control and/or communicate via Serial I/O. The modular construction of the **SPM** allows **O TEK** to customize to your needs without expensive N.R.E., set-ups or minimum orders.

Controller: When you order Serial I/O. (Digit 4 Options 1-3), you can order analog out (Digit 6) and/or relays (Digit 7) and we include math functions, X-Y tables & polynomials with it!

Displays: You can order the large 0.8" 3 1/2 or 4 digit **LED** or the 0.6" 4 1/2 **LED**. **NEW** white LED displays are now available! Standard filter is **red**. For other colors use Option 9 on 8th digit and specify color (depending on availability).

(Option 0) 4 1/2 LED .6"



(Option 2) 3 1/2 LED .8"



(Option 6) 4 LED .8"



IF YOU DON'T SEE IT, ASK FOR IT!



SPECIFICATIONS @ 25°C

Loop Powered:

- Input Range: 3-36mA
- Burden: 5V Max.
- Acc. & Linearity: $\pm 0.1\%$ of F.S. ± 1 Digit

VDC Signal Powered:

- Input Range: 4-30 VDC
- Input Current: 3-25mADC
- Accuracy & Linearity: $\pm 0.1\%$ of F.S.
- mADC Powered: On Request

VAC Signal Powered (P.T.): (For V, W & Hz)

- Isolation from Signal: None
- Input Range: 50-150VAC
- Input Current: Approximately 25mA AC
- Acc. & Linearity: $\pm 0.2\%$ of F.S. ± 1 Digit
- Meas. Method: True RMS
- Frequency Range: 40-440Hz

AAAC Signal Powered (C.T.): (For A & W)

- Isolation for Amps: 500 V
- Isolation for Watts: None
- Input Range: 0.1 -5A F.S.
- Over-Range: 7.5A (5 Sec.)
- Burden: Approximately 1VRMS @ 5A
- Acc. & Linearity: $\pm 0.2\%$ of F.S. ± 1 Digit
- Frequency Range: 40-440Hz
- Meas. Method: True RMS

External Power & Common Specifications:

- (All Plus Sensor's Accuracy) *
- Acc. & Linearity: $\pm 0.1\%$ of F.S. ± 1 Digit
- C.M.R.R.: 100dB @ 50-60Hz
- Temp. Coef.: ± 100 PPM/°C
- Conversion Rate: 2 1/2 Seconds
- Conversion Type: Sigma-Delta
- Step Response: 0.8 Seconds (10-90%)
- Input Type: Diff. & S.E. (2V Max.)
- Baud Rate: 1200-19.2KB
- Protocol: ASCII (8N1)
- Temp. Range: -10 + 70°C
- Humidity: 5-95% N.C.
- MTBF: >100,000 Hours
- Nuclear: To 10CFR50B
- Mil-Specs: To Specifications
- Housing: ABS, 94V0 or Metal
- Connector: Screw Terminal

* See Individual Specs For Specific Accuracy
Note: All readings are ± 1 LSD

520-748-7900

FAX: 520-790-2808

E-MAIL:sales@otekcorp.com

http://www.otekcorp.com

O TEK TM **CORP.**
SINCE 1974

4016 E. TENNESSEE ST.
TUCSON, AZ. 85714 U.S.A.



SPM SERIES continued

HOW IT WORKS:

Current Loop Powered: We use a Zener to clamp the voltage to 5V max. and monitor the Loop's current (we invented it in 1974). (Digits 2 & 3, Option 00). Must use Option 0 on Digit 5.

VDC Signal Powered: We monitor the voltage with high impedance and clamp it to a safe level to power the **SPM**. (Digits 2 & 3, Option 02). Must use Option 0 on Digit 5.

AC Signal Powered: For VAC & Hz we use a capacitor limiting rectifier to power the **SPM** and monitor the VAC with an RMS-DC converter. For Hz we use an F-V for accurate conversion. For A.A.C. we invented (Patent Pending) a C-V converter to extract the current from your C.T. for power and monitor the signal with RMS-DC. (Digits 2 & 3, Options 40-43). Must use Option 0 on Digit 5.

Externally Powered: Non-Isolated 5VDC or isolated 5-48VDC or 90-265VAC 50/60Hz is optional (Digit 5, Options 1-7). Max Power: 2Watts

Serial I/O: When ordered, (Digit 4), the **CPU** controls the Baud Rate (300-9600 Baud), the relays, analog output, math functions, linearization polynomial (9th) & X-Y tables.

Control & Power Out (Digit 6):

You can order 4-20mA as standard, or 0-5V, 0-20mA or 0-24mA on request, or you can order the isolated 30VDC (30mA) or Non-Isolated 28VDC out for your transmitter.

Relays/O.C.T.: You must order the Serial I/O Option to get the relays/O.C.T. options. Standard is normally open (N.O. SPST). On request we can give you normally closed (N.C.). All are 1A @ 120VAC rated. The O.C.T. are normally off, com. emitter 30VDC/100mA max.

THE SIGNAL CONDITIONS:

(2nd & 3rd DIGITS)

Option 00: 4-20mA Powered:

First introduced in 1975, the current flows through a Zener and "Shunt" resistor. The Zener clamps the voltage to about 3.5 Volts and the voltage across the Shunt is measured and displayed. Because an LED acts as a Zener, instead of a Zener the LEDs of the backlite are used to power the meter. If the "burden" (3.5 - 4.5V) is too high for your application, use the externally powered (Option 01). Must use Option 0 on Digit 5.

Accuracy: $\pm 0.1\%$ of F.S.

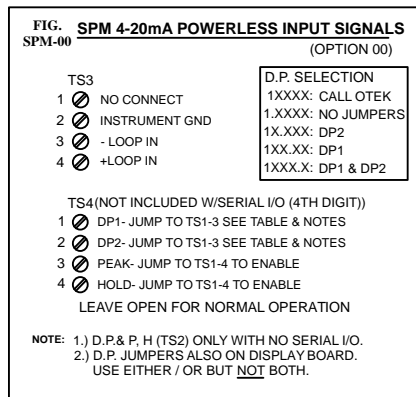

Option 01: 4-20mA Externally

Powered: It only drops 1V @ 20mA (50 Ohms). The "**SPM**" needs 5VDC @ 20mA to operate (including the backlight or LEDs). Note: Digit 5 can not be Option 0. **Accuracy:** $\pm 0.05\%$ of F.S.

Digits 4, 5 & 6 must be Option "0".

Accuracy: $\pm 0.1\%$ of F.S.

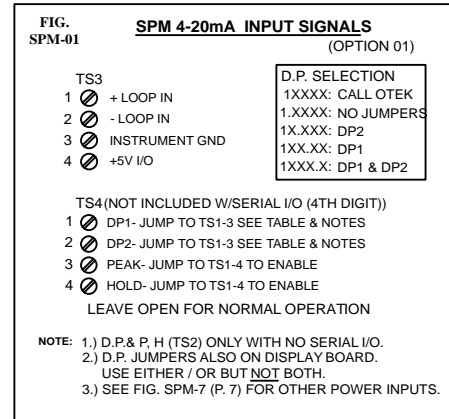

Option 02: 4-30VDC

Signal Powered:

Another **OTEK** innovation. The voltage signal powers an **LDO** to protect the **SPM** and a divider network is used to measure and display the signal. If the input resistance of this Option is too low (~ 500 Ohms), use options 04-08. Note: Digits 4 must be Option "1." Digit 5 & 6 must be Option "0."

Accuracy: $\pm 0.1\%$ of F.S.

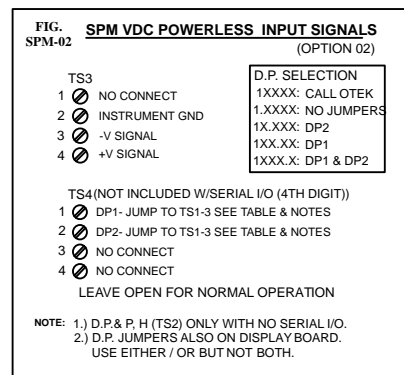

SPM SERIES continued

Option 03: Serial Input Remote Display:

Here you can use the **SPM** as a remote display with modified (STD.) ASCII to alpha-numeric display for DCS SCADA, PLC systems. Note: Serial input options 1-3 on Digit 4 must be ordered.

Options 04-08: VDC Externally Powered:

Input impedance is 1 Mega Ohms on all VDC ranges.

Accuracy: ±0.1% of F.S.

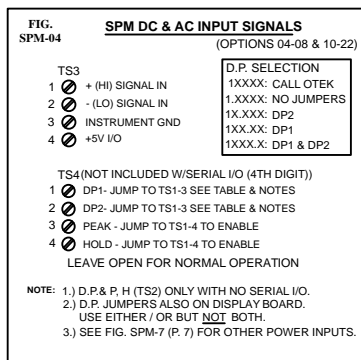

Option 09: Custom: Use this option to describe any custom input, scale or modification to the **SPM** and contact us for feasibility and cost.

Options 10-13: 200µA - 200mADC:

Since the **SPM** is 200mV full scale (20,000 Counts) the "Shunt" resistors used are 1K, 100, 10 or 1 Ohm. Don't forget that maximum display is 19,999 not 20,000!.

Accuracy: ±0.1% of F.S.

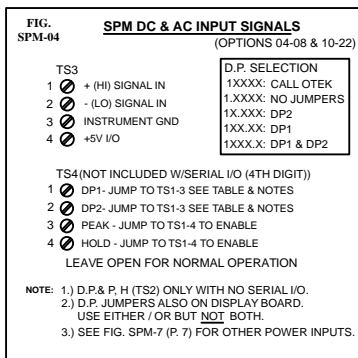

Options 14-22:

V & mA RMS: Here we use a **True RMS-DC** Converter for accurate (± 0.1%) measurement of sine waves up to 10KHz and SCR;s fired to ± 1%. Input impedances vs. range are the same as for VDC & mADC ranges. **Warning: No Isolation!**

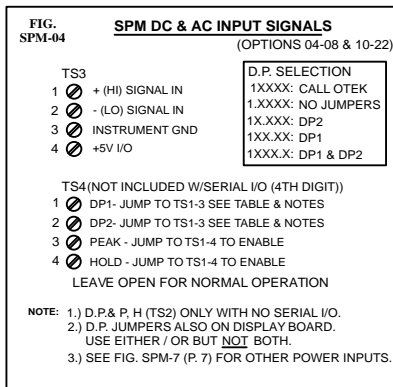

Option 23: 5Amps AC:

Specifically for current transformers (**C.T.**) this option requires an externally mounted (supplied) 0.05 Ohm, 0.1% 5 Watt resistor. You can mount the "Shunt" at your **C.T.** or next to the **SPM** but make sure the connections are "Perfect" to electrical codes. The C.T. might have "**Lethal**" High Voltage without a "Shunt" (Open) and the **SPM** will "Smoke". See OTEK's New **ACS & CTT** models for **C.T.** powered instruments (Patent # 7,626,378).

Warning: No Isolation!

Accuracy: ±0.2% of F.S.

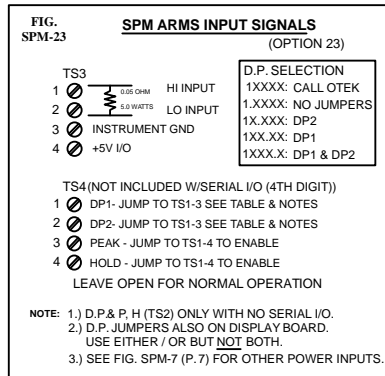

Option 24: Strain-Gage (<1000 Ohm Type): Here we use high accuracy and stability constant current (~1mA) source, and a differential amplifier to convert the 2 or 3mV/V (typical) sensitivity of your "Load-cell". **Specify** your Strain-Gage sensitivity and full scale and the **SPM's** display at Zero and Full Scale Please!

Accuracy: ±0.1% of F.S.

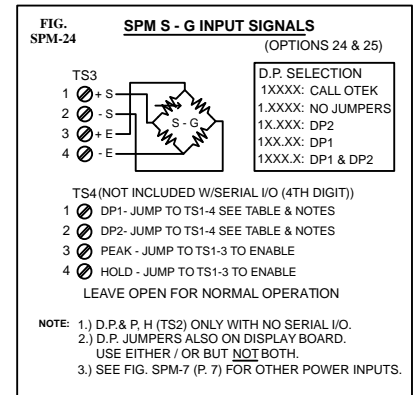

Option 25: Strain-Gage (≥1K < 4K Ohm):

These are typically "Monolithic" **S-G** that require constant voltage (preferably) excitation. We use 4.096V for high stability and accuracy. **Specify** your S-G impedance and sensitivity and the **SPM's** display at Zero and Full Scale.

Accuracy: ±0.1% of F.S.

Note on S-G: Some S-G offer +/- 1VDC or 4-20mA condition output. Use Option 9 and specify.

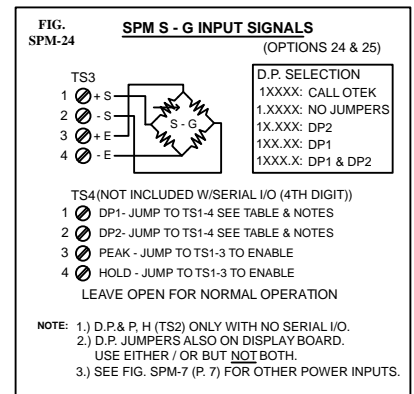

SPM SERIES continued

Option 26: RTD (PT100): We excite your 2, 3 or 4 wire RTD with 200µA to avoid the "self heating" effect. The range of the **SPM** is the same as your **RTD** typically -200°C to +800°C (-328 + 1562°F). You can place the decimal point at will (typically -200.0 to 800.0 (-328.0 to 1562.0)). The **PT100** has a temperature coefficient of 0.00385 Ohms/Ohm/°C. (For legacy 0.00392 TC (known as ANSI 392) contact **OTEK** and use Option "09".)

Note: If you order Serial I/O (Options 1-3, Digit 4), you can change °C to °F and RTD type via serial port.

Accuracy: ±0.1% of F.S. plus sensor's error.

Note: For 2 wire, jump - S to -E and +S to +E. For 3 wire only jump -S to -E.

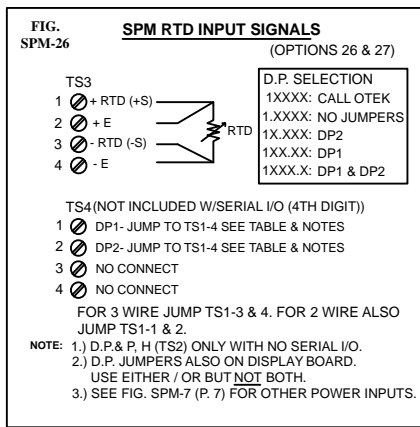

Option 27: RTD (PT1000):

Same as PT100 except it is 1000 Ohms at 0°C instead of 100 Ohms @ 0°C. The same technique is used for copper **RTD** (10 Ohm), contact **OTEK**. Same connection as Option 26 apply.

Accuracy: ±0.1% of F.S. plus sensor's error. Note: For long distances use a 4-20mA transmitter such as our **900** or **LPT** series.

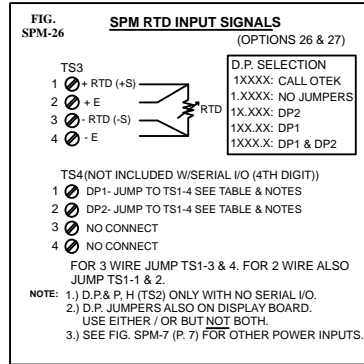

Option 28: Thermocouple (Type J):

This **TC** has a range of -210 to + 760°C (-350 + 1390°F). Its color is white (+) and Red (-), cold junction (CJ) is inside the **SPM** at the connector base. Make sure the connections from the **SPM** and your **TC** are as close to the **SPM's** entrance as possible to avoid errors. If you short out the **SPM's** +**TC** & -**TC** together, the **SPM** will read the ambient temperature due to its built-in C.J.C. Note: If you order Serial I/O you can change °C to F and TC type via serial port.

Accuracy: ± 2⁰

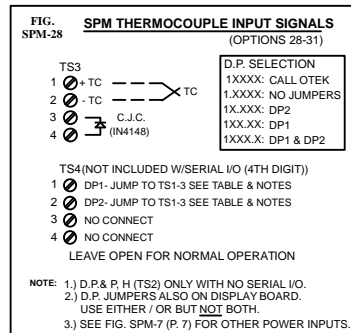

Option 30: TC (Type K): This is yellow (+) and red (-) and has a range of -270 + 1370°C (-440 + 2500°F). The same notes as Option 28 apply.

Accuracy: ± 2⁰

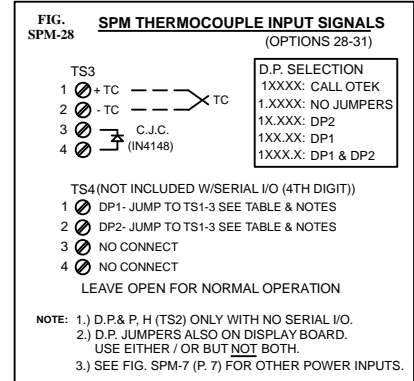

Option 31: TC (Type T): This blue (+) and red (-) **TC** wire has the range of -270⁰ + 400°C (-440 + 750°F). Same notes as Option 28 apply.

Accuracy: ± 2⁰

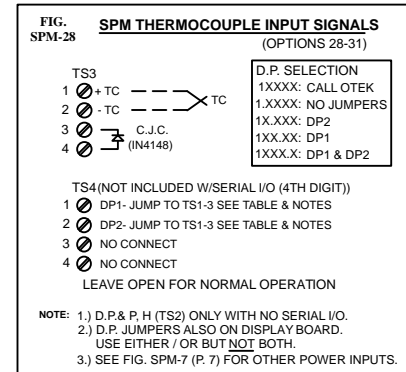

SPM SERIES continued

Options 32-33: Frequency Input:

We use an **F-V** to accept frequencies from 40 - 20KHz and amplitudes from 1-400V peak or dry contact or open collector transistor (O.C.T.). For 50 to 440 Hz power line frequency measurement. Use Option # "33" or see our **ACS** Powerless™ Series.

Accuracy: ±0.1% of F.S.

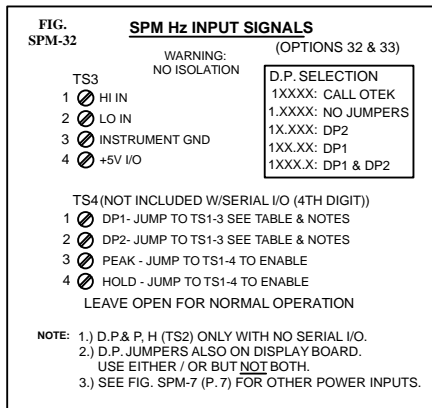

Option 34: %RH: This conditioner is designed to interface to a typical (capacitance type) 2-3pF/% of **RH** made by several manufacturers. Use Option "09" and contact **OTEK** to specify your sensor's specifications.

Accuracy: ± 0.1% RH of signal input.

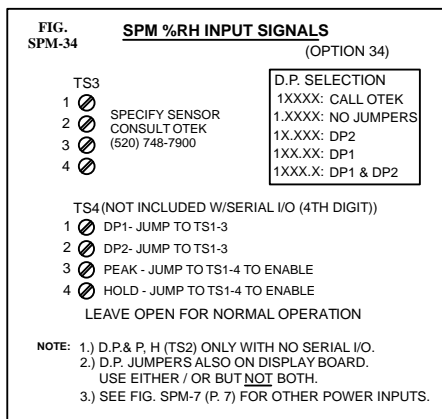

Option 35: pH (Acidity): We use a FET input (10^{15}) amplifier and calibrate the **SPM** for 0-14.00 pH using the Industry's standard $\pm 413 \text{ mV} = \pm 7\text{pH}$ co-efficient. Note: Not temperature compensated.

Accuracy: ±0.1% of F.S.

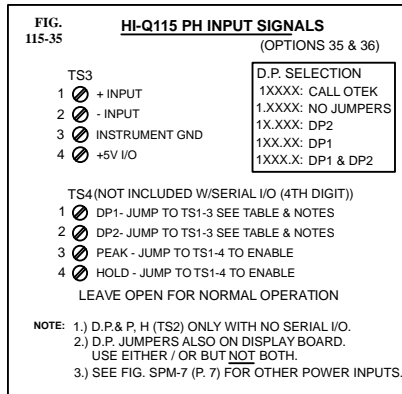

Option 36: ORP (Oxygen Reduction Potential): Our FET amplifier (10^9) accepts the industry standard 2000mV F.S. of the probe and the **SPM** displays it in % (0-100.00%).

Accuracy: ±0.1% of F.S.

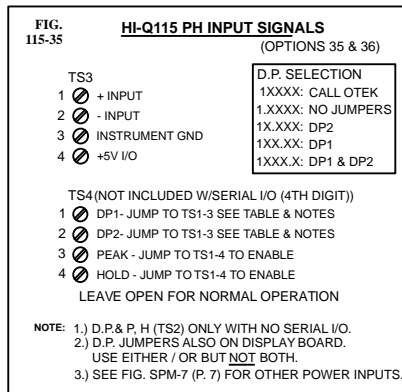

Option 37: Hi Speed Peak & Hold (P&H): Now you can capture fast transients greater than 50 microseconds (even faster soon) with resolution greater than 0.1% of F.S. and retention of greater than 10 years (Due to OTEK's new and patent-pending P&H Option).

Input: V or mADC (Specify Range). Contact OTEK for V/mA RMS or Loop Powered).
Accuracy: ±0.1% of F.S.
Linearity & Resolution: +/- 0.05% of F.S.
Response time: >20KHz (<50us)
Retention: >10 years (with power on).

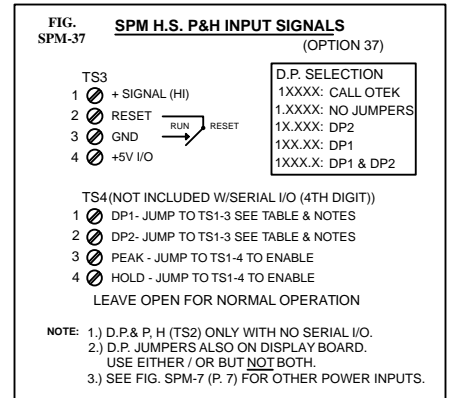

SPM SERIES continued

Note: Options 40-43 only available with Powerless™ power input (Digit 5, Option 0)

Option 40: VAC Signal Powered:

Warning! No Isolation! This option uses the AC Voltage Signal to power the **SPM**. Since the **SPM** uses about 30mA @ 5VDC, we use a coupling capacitor AC-DC converter to generate 5VDC and not to "Load" the signal with a transformer. Consequently, your signal source should be capable of producing about 150mW without overloading it, otherwise use Options 14-17 (externally powered). Range: 50-150VAC; Method: RMS Calibrated; Accuracy & Linearity: $\pm 0.2\%$ of F.S. Best and safest when driven by a P.T. (Potential Transformer). **Always turn power off before connecting!**

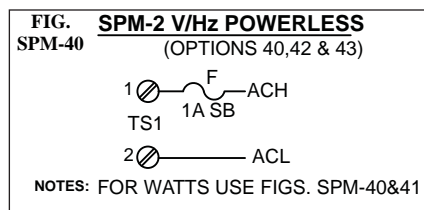

Frequency Range: 50-440 Hz.

Option 41: AAC Signal Powered:

Warning! No Isolation! (Pat. Pend.)

OTEK's Patents (#726,626,378 & 4,908,569) permit the extraction of power from a regular **C.T.** (Current Transformer) to power the **SPM** without distorting the signal. Since this option is designed to be powered from a C.T., it should not be connected directly to the mains without limiting the current and proper electrical grounding. **Lethal Voltage** might be present at the C.T. secondary (output) if the secondary is open. **Always turn power off before connecting!** Range (at C.T. output): 0.1-5AAC; Overload: 50%/30 seconds; Peak: 100%/1 second; Conversion: True RMS; Accuracy & Linearity: $\pm 0.2\%$ of F.S.; Burden on C.T.: <150mW.

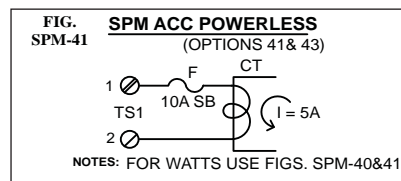

Frequency Range: 45-65 Hz.

Option 42: Hertz (Frequency) Signal Powered: **Warning! No**

Isolation! This option uses the same power technique as Option 40 above and the same precautions and warnings apply. Here we use a "Zero Crossing" detector and a F-V converter to give you the **A.C.** line frequency display with 0.1 Hz resolution. Range: VAC: 50-150VAC/Frequency: 30-450Hz; Accuracy & Linearity: $\pm 0.1\%$ of F.S.

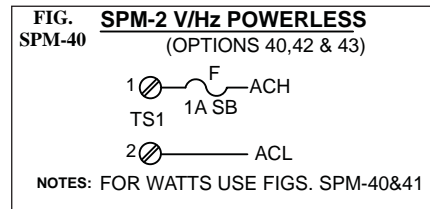

Frequency Range: 50-440 Hz.

Option 43: Signal Powered AC Watts: **Warning! No Isolation!**

Here we combine the powerless VAC & AAC options to arrive at real power calculations through our **CPU** and **DAC**. The same warnings and precautions of Options 40 & 41 apply. Range: VAC: 50-150; AAC: 0.1 - 5A; Frequency: 45-65Hz; Accuracy & Linearity: $\pm 0.2\%$ of F.S.; Conversion: True RMS. Contact **OTEK** for other functions.

Note: For watts, use Fig. 40 & 41. Do **NOT** reverse connectors.

Serial I/O (DIGIT 4): WARNING: No Isolation From Signal.

Option "0": No Serial I/O:

Only options 0 on digit 6 is available when option "0" on 5th digit is selected.

Option 1: RS232: 1200-19.2kb, all ASCII (8N1) open protocol screw connector terminals.

Option 2: RS485: 1200-19.2kb, all ASCII (8N1) open protocol screw connector.

WARNING: Serial I/O **MUST** use C.T. & P.T. on input options 40-43 for isolation. OTEK assumes no liability.

SPM SERIES continued

Option 3: USB: 1200-19.2kb, all ASCII (8N1) open protocol "USB Type B."

Any terminal program (Hyperterminal, Procomm, Kermit) will work with OTEK's serial com. ports. For USB download our Driver at www.otekcorp.com/Support/Downloads/PC-USB-Driver.

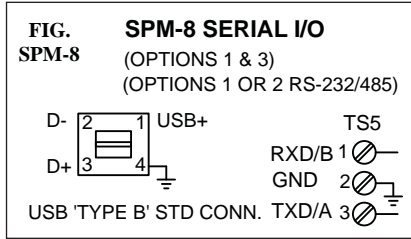

Power/Input (DIGIT 5):

Option 0: Powerless™: The **SPM** is powered from the signal that it measures. ONLY available for options 00, 02 and 40 through 43 of input signal (Digits 2 & 3). **WARNING:** Any other I/Os are NOT isolated from signal. Options 40-43 (Digits 2 & 3) could have lethal potentials!

See specific Option # & Connections

Option 1 or 7: Non-Isolated 5 or 7-32 VDC Power: See Specific Option # & Connections.

All listed I/O options (except Powerless™) are available. Power requirements vary with options included. The **SPM** with No Control and Power Out (Digit 6, Option 0) requires under 150 mW (30 mA@5VDC) for LED display.

Options 2-6: Isolated Power

These options offer minimum isolation of 500 VAC or DC and their efficiency is about 80%. Again, add all the options: power x1.2 to arrive at total power required. Options 3, 4, 5 & 7 have wide input range, all others +/- 5%. Option 7 is non-isolated 7-32 VDC/input range.

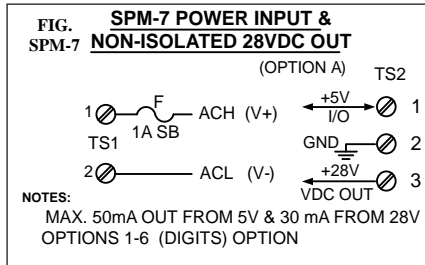

CONTROL & POWER OUT (DIGIT 6): Not available with Powerless™ inputs.

Option 1: Relays (4): Standard outputs are SPST, N.O. of all 4 relays. For N.C. of all 4 relays or SPDT of only 2 relays or other contact combination select option 9 and specify. Contacts are rated at 1 amp at 120 VAC/30 VDC resistive load. Also applies to option 5 & 7 (Relays). Power required by each relay is 200 mW (40mA@5VDC) x 4=800 mW. (Contact OTEK for 10 A contacts).

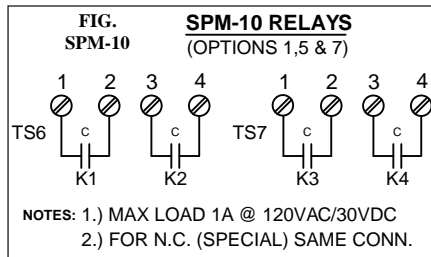

Option 2: Open Collector Transistors (O.C.T):

Four O.C.T are included and all are common emitter (sinking) to digital ground (terminal TS1-2). The 5 VDC internal powers is available at terminal TS1-1. Maximum current allowed per O.C.T. (From the internal 5 VDC) is 20mA/O.C.T. if external VCC is used, the maximum VCE is 30 VDC and 30 mA per O.C.T. Switching time is under one (1) uSecond.

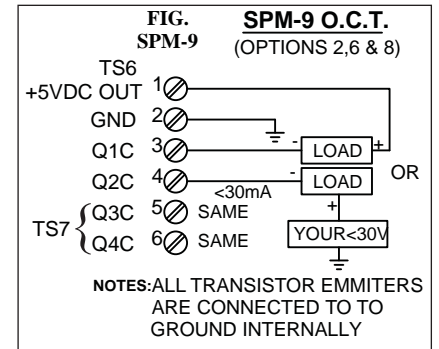

Option 3: Isolated 4-20 mA: (Must include serial I/O options 1-3 Digit 4)

This option is offset & scaled via the serial port (digit 4) and can be configured for 4-20, 0-20 or 0-24 mA or 0-5 VDC via internal jumpers (standard is 4-20 mA). This option requires under 200 mA@5VDC internal power due to step up from 5-30 VDC compliance. Accuracy & linearity is +/- .1% of setting and can drive up to 1K ohms load. Also see Option B.

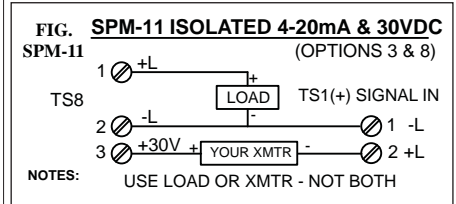

SPM SERIES continued

Option 4: Isolated 30 VDC

You can use it to excite your transmitter at up to 25mA. It consumes under one (1) watt at full load. Also see Option A.

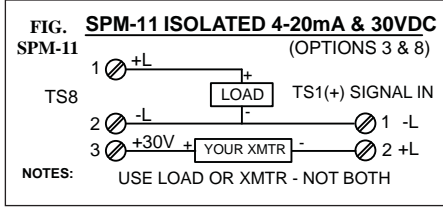

Option 5-8: Combinations of Option 1-4.

Don't forget to add all power requirements of each option desired.

See Options 1-4 & Connections.

Option A: Non-Isolated 28VDC For Transmitters.

It converts the internal 5 VDC to 28 VDC and requires under 0.8 watts@5 VDC with max current output of 25mADC.

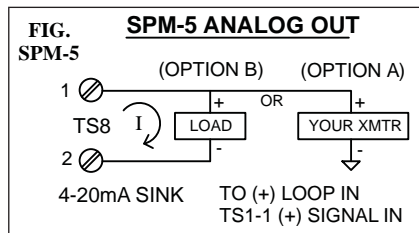

Option B: Non-Isolated 4-20 mA Out.

This option converts the SPM to a low-cost transmitting DPM. The output is referenced to the SPM's Signal input after it has been conditioned by the signal conditioner (such as strain-gage, Hz, pH, etc.), and it has its own zero and span potentiometers for your customized range. Standard connections are for sourcing with burden under 700 ohms @ 20 mA. For external compliance and sinking, select option #9 and specify "external compliance" (you supply the VDC power for the 4-20mA transmitter). Minimum voltage is 5 VDC plus your load. Max is 30 VDC plus your load. Accuracy and linearity is $\pm 0.1\%$ of full scale. Power requirement is 800mW@5VDC internal compliance or 50mW with external (yours) compliance. Also see Option 3.

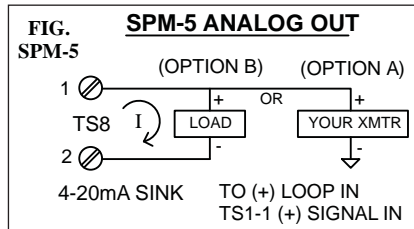

CASE TYPE (DIGIT 7):

Option 0, Plastic: ABS 94VO black is standard. All options have 2 piece plug-in screw terminal connectors and seismic tested mounting slides (2).

Option 1, Metal: Aluminum machined, nickel plated (ready for EMI/RFI compliance), black powder coated.

Option 2 & 3, Nema 4X: We add a neoprene or monel gasket for full front panel water proof. (No Span or Zero front panel adjustments).

Option 9, Custom: Use this to specify your needs. M&N options, digit 1 automatically get metal housings (Option 3).

DISPLAY TYPE (DIGIT 8):

Option 0: -1.9.9.9.9
Option 2: -1.9.9.9, 0.8" High
Option 6: 9.9.9.9, 0.8" with negative sign & over-range LEDs above and below MSD.

Zero & Span Adjustments:

(Zero on right, span on left). Always adjust zero before span. NOTE: Nema 4X, Mil-STD and nuclear have no front panel adjustments. Unit must be removed from housing for calibration (Normally not required).

CONNECTORS: All connectors are 2 piece plug-in on 3.5 mm centers. Min-max gauge accepted is 26-16.

SPM MECHANICAL INFORMATION

ACTUAL DISPLAY WILL VARY

ACTUAL CONNECTORS WILL VARY

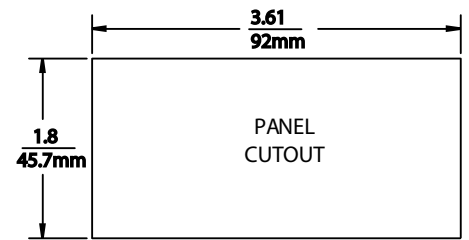
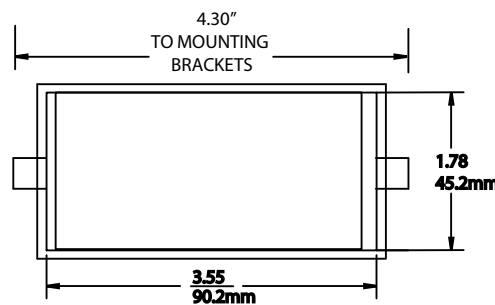
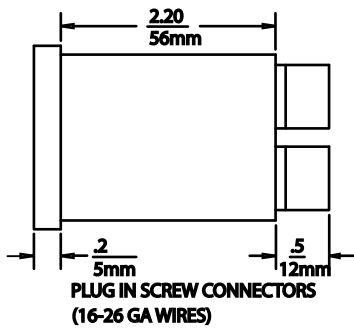
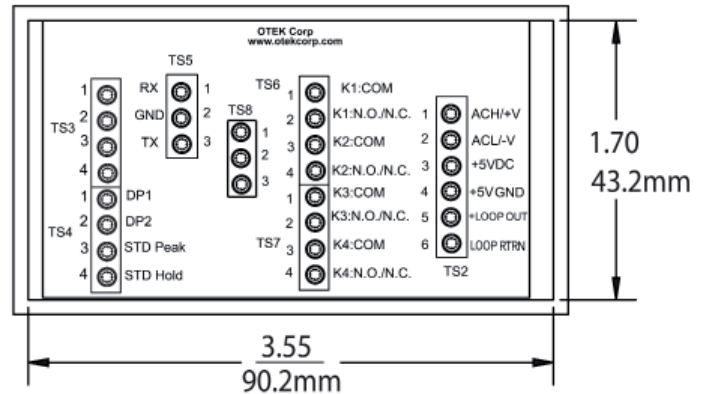
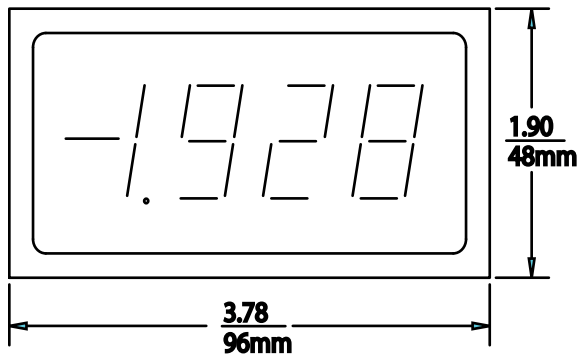

Note: For serial commands see www.otekcorp.com/content/manuals SPM-SRD Manual.

SPM MOUNTING INSTRUCTIONS

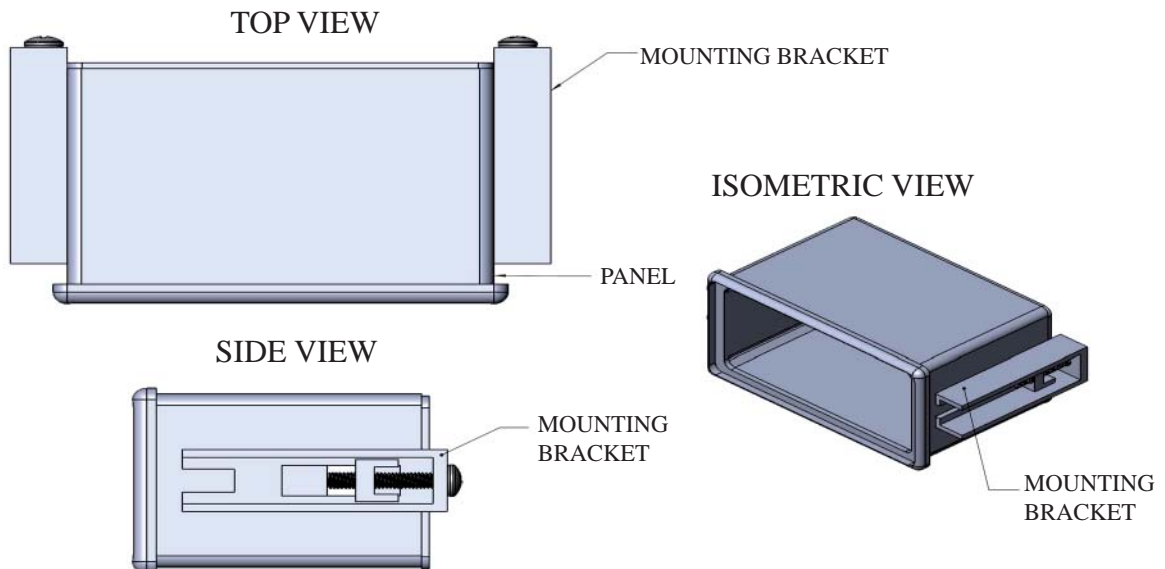

MOUNTING INSTRUCTIONS:

1. Remove mounting bracket and hardware.
2. Slide meter into panel cutout from front of panel.
3. Reattach mounting bracket and hardware
4. Tighten screws on rear of meter to secure in panel.

SPM SERIES ORDERING INFORMATION

NOTE: Please READ BEFORE building part number:

1. If digits 2 & 3 are options 00 or 02, then digit 4 must be option 0 or 4, and digits 5 and 6 must be option 0.
2. If digits 2 & 3 are options 40, 41, 42 or 43, then digits 4, 5 and 6 must be 0.
3. If digit 6 are options 1-3 or 5-8, then digit 5 must be options 1-7 and digit 4 must be options 1-3.
4. See notes at bottom of page.

Model: SPM -

GRADE (5)

- I.....Industrial
- M.....Mil-Spec
- N.....Nuclear (Contact OTEK)
- 9.....Custom (Contact OTEK)

INPUT SIGNAL (1,2,6)

- 00.....4-20mA Loop Powered
- 01.....4-20mA External Powered
- 02.....4-30VDC Signal Powered
- 03.....Serial Input Remote Display
- 04.....±200mVDC
- 05.....±2VDC
- 06.....±20VDC
- 07.....±200VDC
- 08.....±50mVDC
- 09.....Custom (Contact OTEK)
- 10.....± 200µADC
- 11.....±2mADC
- 12.....±20mADC
- 13.....±200mADC
- 14.....200mV RMS
- 15.....2V RMS
- 16.....20V RMS
- 17.....200V RMS
- 18.....50mV RMS
- 20.....2mA RMS
- 21.....20mA RMS
- 22.....200mA RMS
- 23.....5 Amp RMS
- 24.....Strain-Gage (<1K Ohm)
- 25.....Strain-Gage (>1K Ohm)
- 26.....RTD (PT100)
- 27.....RTD (PT1000)
- 28.....TC (Type J)
- 30.....TC (Type K)
- 31.....TC (Type T)
- 32.....Frequency (40-20KHz)
- 33.....Frequency (50-440Hz Line)
- 34.....% RH (Specify Sensor)
- 35.....pH (0-14.00)
- 36.....ORP (0-2000mV)
- 37...Hi Speed Peak & Hold (2 VDC)
- 40.....VAC Signal Powered
- 41.....AAC Signal Powered
- 42.....50-440 AcHz Signal Powered
- 43.....WAC Signal Powered

SERIAL I/O (1,2,3)

- 0.....None
- 1.....Non-Isolated RS232
- 2.....Non-Isolated RS485
- 3.....Non-Isolated USB
- 4.....Parasitic RS232E
- 9.....Custom (Contact OTEK)

RANGE/CALIBRATION

- 0.....Standard
- 9.....Custom (Contact OTEK)

DISPLAY TYPE (8)

- 0.....4 1/2 Digits 0.6" Red LED
- 2.....3 1/2 Digits 0.8" Red LED
- 6.....4 digits 0.8" Red LED
- 9.....Custom (Contact OTEK)

CASE (7)

- 0.....Plastic
- 1.....Metal
- 2.....Plastic/Nema 4
- 3.....Metal/Nema 4
- 9.....Custom (Contact OTEK)

CONTROL & POWER OUT (1,2,3)

- 0.....None
- 1.....Relays (4)
- 2.....O.C.T. (4)
- 3.....Isol. 4-20mA
- 4.....Isol. 30VDC For XMTR
- 5.....Relays & Isol. 4-20mA
- 6.....O.C.T. & Isol. 4-20mA
- 7.....Relays & Isol. 30VDC For XMTR
- 8.....O.C.T. & Isol. 30 VDC for XMTR
- 9.....Custom (Contact OTEK)
- A.....Non-Isol. 28 VDC For XMTR
- B.....Non-Isol. 4-20 mA Out

POWER INPUT (1,2,3)

- 0.....Signal/Loop Powered
- 1.....Non-Isolated 5VDC
- 2.....Isolated 5VDC
- 3.....Isolated 7-32VDC
- 4.....Isolated 90-265VAC
- 5.....Isolated 9-36VDC
- 6.....Isolated 48VDC
- 7.....Non-Isolated 7-32VDC
- 9.....Custom (Contact OTEK)

NOTES (Continued):

5. Otek will build to certain nuclear or MIL-standards but testing and confirmation of compliance, if required, will need to be done by a third party and at customer's expense.
6. See "ACS" series for V, A, W, Hz, AC Powerless.
7. NEMA 4x front panel only.
8. LED standard color is red. For orange, yellow, green or blue use option 9 and specify color.

DOWNLOADS: For manuals, user-software or drivers:
www.otekcorp.com