

**WORLD'S
FIRST**

LOOP POWERED LED PANEL METER WITH SERIAL I/O FOR MIL-SPEC, NUCLEAR & INDUSTRIAL

>30 INPUT SIGNAL CONDITIONERS (3-19-19)

**MODEL
LPE**

PAT # 7,477,080

REAR VIEW



2.80" X 1.310" PANEL CUTOUT
BEZEL: 2.91 X 1.52"

SIDE VIEW

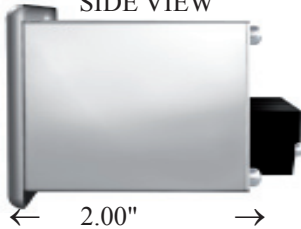

← 2.00" →

FEATURES:

- 4 1/2 0.6" LED Digits
- Low Burden: \leq 5VDC
- Metal or Plastic Housing
- Also 5-48VDC & 90-265 VAC Powered
- RS232, 485 or USB I/O
- Captive Screw Terminal Connector
- NEMA 4X, EMI/RFI Gaskets
- Serial Input Remote Display
- No Feed Through Noise
- 28VDC Power For Transmitter
- Lifetime Warranty

NEW: VDC MULTIRANGE 2-500V!

NVG3 on Request

Front View



Span

Zero

SPECIFICATIONS @ 25°C (Industrial Grade)

DESCRIPTION

Another World's First By **OTEK!** To complement its world's first **LCD** (Model LPM) **Loop Powered** Meter, **OTEK** developed the exact counter part but with super high efficiency 0.56" **LED** display, RS232E and all **Loop Powered!**

Several Configurations are Available:

1. **Loop Powered:** Just connect 2 wires (+ & - Loop)
2. **Loop Powered with RS232E:** Just connect 5 wires
3. **USB, 5, 12, 24 or 48VDC Input Power:** Just connect 4 wires
4. **90-265VAC Input Power:** Just connect 4 wires
5. **Power for Transmitter:** Just connect 4 wires
6. **Serial In Remote Display:** Just connect 3 wires

The Connector: Seismic Qualified Captive

The Housing: Aluminum Nickel Plated or Plastic, Seismic Qualified. Optional **Sanitary** housing available.

Adjustments: Front panel adjustments, or via Serial Port.

The Serial I/O: (Optional): RS232E for Loop Powered RS232D, 485 or USB for external power.

The Grades:

- a. Intrinsically Safe (IS) by design, for CLI, Div. 1 & 2.
- b. Mil-Specs: To Your Requirements.
- c. Nuclear: 10CFR1050B
- d. Industrial: -10 + 70°C, 5-95% RH

The Technology: ASIC Nanotechnology for greater reliability.

Loop Powered Models:

- Burden: 5VDC Max. (7V For "S" Version)
- Max. Input Current: 36mA, Max. Volts: 30V
- Min. Input Current: 3.6mA
- Accuracy & Linearity: $\pm 0.01\%$ of F.S. ± 1 Digit
- Span Adjustment: ± 3000 Counts of F.S. (10,000)
- Zero Adjustment: ± 3000 Counts of Zero (00000)
- Standard Calibration: 4-20 = 0-10000, Others On Request
- Serial I/O: RS232E

NOTE: Display brightness is proportional to loop current.

Powered Models:

- Loop Burden: 1V@20mA; 50 Ohms (w/o microcontroller)
- Current Requirement @ 5V: 25mA (w/o microcontroller)
- Current Requirement @ 5V: 30mA (with microcontroller)
- Power Input: USB, 5VDC, 5-48VDC, 90-265VAC

OTHER SPECIFICATIONS

- Display: LED, 0.56" Tall, High Efficiency
- Input Type: Differential & Single Ended. 10M For VDC
- Common Mode R.R.: 100dB @ 50/60 Hz
- Conversion Rate: 2.5/Second
- Step Response: 0.8 Sec. (0-90% of F.S)
- Common Mode Voltage: ± 2 VDC
- Op./Storage Temp: -10 +70/ -20 + 70°C
- MTBF: >100,000 Hours
- Serial I/O: RS232/485/USB, 300-19.2KB (8N1)
- RH: 5-95% RH Non-Condensing
- Temperature Coefficient: 50PPM/°C
- Plastic Case: 94VO Textured Black
- Metal Case: Aluminum Nickel Plated
- Sanitary Case: To 250°F Steam Cleaning

520-748-7900

FAX: 520-790-2808

E-MAIL: sales@otekcorp.com

http://www.otekcorp.com

OTEK™
CORP.

SINCE 1974

4016 E. TENNESSEE ST.
TUCSON, AZ. 85714 U.S.A.

MADE
IN
USA



LPE continued

HOW IT WORKS:

AC SIGNAL POWERED: For VAC & Hz we use a capacitor limiting rectifier to power the **LPE** and monitor the VAC with an RMS-DC converter. For Hz we use an F-V for accurate conversion. For A.A.C. we invented (Pat. # 4,908,569) a C-V converter to extract the current from your C.T. for power and monitor the signal with RMS-DC. (Digit 2, Options Q-T). See note under option "Z."

EXTERNALLY POWERED:

Non-Isolated 5VDC or isolated 5-48VDC or 90-265VAC 50/60Hz is optional (Digit 3, Options 0-7). Max Power: 1 Watt.

INPUT TYPE (DIGIT 2)

OPTION 0, LOOP POWERED:

Only 2 wires (+L & -L) are required. The **LPE** requires >3mA to operate at ~4 V drop, if the 4V drop is too much, select Option 1 (Externally Powered) Also, display intensity is lowest at 4mA and brightest at 20mA.

**CONNECTIONS:
FIG. LPE-0**

OPTION 0, LOOP POWERED

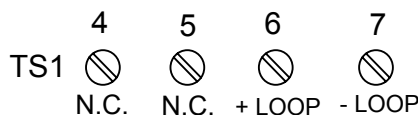

OPTION 1: 4-20mA EXTERNALLY POWERED:

It only drops 1V @ 20mA (50 Ohms) but the "**LPE**" needs 5VDC @ 50mA to operate. Accuracy: ±0.05% of F.S.

**CONNECTIONS:
FIG. LPE-1**

**OPTIONS 1-7, C-N, T-V
EXTERIOR POWERED**

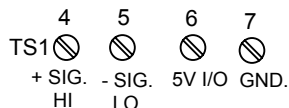

NOTE: OPTION N INCLUDES 0.04 OHM 5W SHUNT AT TERMINALS 4 & 5

OPTIONS 2-7: VDC & mADC EXTERNALLY POWERED:

Input impedance is 1 Mega Ohms on all VDC ranges and 1K Ohms on 1 mA range.

Accuracy: ±0.05% of F.S.

**CONNECTIONS:
FIG. LPE-1**

**OPTIONS 1-7, C-N, T-V
EXTERIOR POWERED**

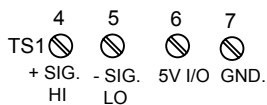

NOTE: OPTION N INCLUDES 0.04 OHM 5W SHUNT AT TERMINALS 4 & 5

OPTIONS 8: HERTZ SIGNAL

POWERED: Warning: NO Isolation!

Use P.T. The **LPE** is powered by the signal from your P.T. (~150mW) and converts the frequency to voltage. Frequency range is 50-440 Hz. Also see Option "T" for up to 20K Hz. Note: Digits 5 & 6 must be option 0.

CONNECTIONS:

**FIG. LPE-8/Y OPTIONS 8/Y
VAC OR HZ SIGNAL POWERED**

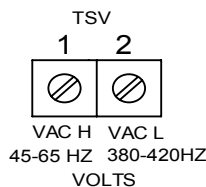

OPTION 9: CUSTOM: Use this option to describe any custom input, scale or modification to the **LPE** and contact us for feasibility and cost.

Option A: 4-30VDC Signal Powered:

Another **OTEK** innovation. The voltage signal powers an **LDO** to protect the **LPE** and a divider network is used to measure and display the signal. If the relatively low impedance (500 Ohms) and current (3-20mA) required by this Powerless™ technique is unacceptable, use Options 2-8 (externally powered).

**CONNECTIONS:
FIG. LPE-A**

**OPTION A
VDC SIGNAL POWERED**

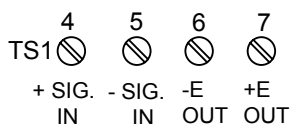

Option B: AC Watts Signal Powered:

Warning! No Isolation! Here we combine the powerless VAC & AAC options to arrive at real power calculations through our **CPU** and **DAC**. The same warnings and precautions of Options Q & R apply. Range: VAC: 50-150; AAC: 0.1 - 5A; Frequency: 40-450Hz; Accuracy & Linearity: ±0.1% of F.S.; Conversion: True RMS. Contact **OTEK** for other functions. Note: Digits 5 & 6 must be option 0.

CONNECTIONS:

**FIG. LPE-B OPTION B
WATTS SIGNAL POWERED**

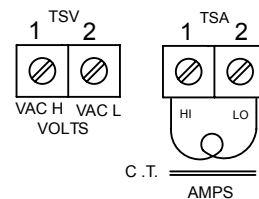

Option C & D:

These are higher sensitivity (10uV) versions of Option 5. Zin is 1 MEG Ohm. Same Connections.

**CONNECTIONS:
FIG. LPE-1**

**OPTIONS 1-7, C-N, T-V
EXTERIOR POWERED**

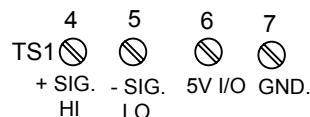

NOTE: OPTION N INCLUDES 0.04 OHM 5W SHUNT AT TERMINALS 4 & 5

Options E-M: V & mA RMs:

Here we use a **True RMS-DC** Converter for accurate (± 0.05%) measurement of sine waves up to 10KHz (± 0.5%, 10-20KHz) and SCR;s fired to ± 2%. Input impedances vs. range are the same as for VDC ranges.

**CONNECTIONS:
FIG. LPE-1**

**OPTIONS 1-7, C-N, T-V
EXTERIOR POWERED**

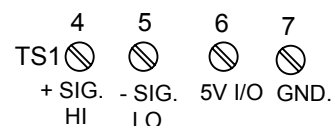

NOTE: OPTION N INCLUDES 0.04 OHM 5W SHUNT AT TERMINALS 4 & 5

LPE continued

Option N: 5Amps AC: Specifically for current transformers (**C.T.**) this option requires an externally mounted (supplied) 0.05 Ohm, 0.1% 3 Watt resistor. You can mount the "Shunt" at your **C.T.** or next to the **LPE** but make sure the connections are "Perfect" to electrical codes. The C.T. might have "**Lethal**" **High Voltage** without a "Shunt" (Open) and the **LPE** will "Smoke". See OTEK's New **ACS** models for **C.T.** powered instruments (Patent Pending).

CONNECTIONS:
FIG. LPE-1

OPTIONS 1-7, C-N, T-V
EXTERIOR POWERED

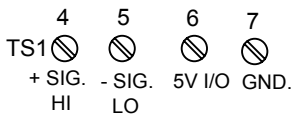

NOTE: OPTION N INCLUDES 0.04 OHM 5W SHUNT AT TERMINALS 4 & 5

Option P: Strain-Gage (<1K Ohm Type): Here we use a highly accurate and stable constant current (~1mA) source, and a differential amplifier to convert the 2 or 3m V/V (typical) sensitivity of your "Loadcell." **Specify** your Strain-Gage sensitivity and full scale and the **LPE's** display at Zero and Full Scale Please!

Accuracy: ±0.05% of F.S.

CONNECTIONS:
FIG. LPE-P

OPTIONS P/Q, STRAIN GAGE

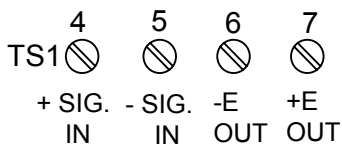

Option Q: Strain-Gage (≥1K < 5K Ohm): These are typically "Monolithic" **S-G** that require constant voltage (preferably) excitation. We use 4.096V for high stability and accuracy. **Specify** your S-G impedance and sensitivity and the **LPE's** display at Zero and Full Scale.

CONNECTIONS:

FIG. LPE-P
OPTIONS P/Q, STRAIN GAGE

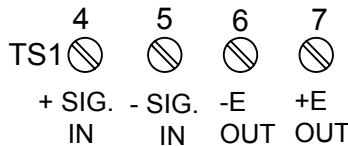

Option R: RTD (PT100): We excite your 2, 3 or 4 wire RTD with 200uA to avoid the "self heating" effect. The range of the **LPE** is the same as your **RTD** typically -200°C to +800°C (-328 + 1562°F). You can place the decimal point at will (typically -200.0 to 800.0 (-328.0 to 1562.0)). The **PT100** has a temperature coefficient of 0.00385 Ohms/Ohm/°C. For 1000 Ohm RTD & legacy 0.00392 TC (known as ANSI 392) contact **OTTEK** and use Option "09".

CONNECTIONS:

FIG. LPE-R
OPTION R, RTD

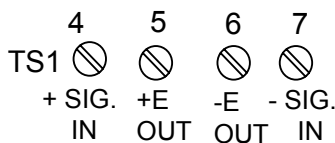

FOR 3 WIRE, JUMP 6 & 7
FOR 2 WIRE, JUMP 4 & 5
AND 6 & 7

Option S: Thermocouple (Type J): This **TC** has a range of -210 to +760°C (-350 + 1390°F). Its color is white (+) and Red (-), cold junction (CJ) is inside the **LPE** at the connector base. Make sure the connections from your **TC** are as close as possible to avoid errors and calibrate after connecting. If you short out the **LPE's** TC wires together, the **LPE** will read the ambient temperature due to its built-in C.J.C.

Contact **OTTEK** for types "K," "T" and others, including copper (10 Ohms).

CONNECTIONS:

FIG. LPE-S
OPTION S, TC

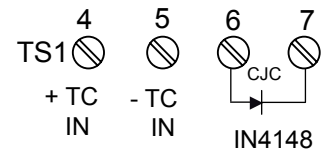

Options T: Frequency Input:

We use an **F-V** to accept frequencies from 40 - 20KHz and amplitudes from 1-400V peak or dry contact or open collector transistor (O.C.T.). For 50-440 Hz power line frequency measurement use Option #"8" or see our **ACS** Powerless™ Series.

CONNECTIONS:

FIG. LPE-1
OPTIONS 1-7, C-N, T-V
EXTERIOR POWERED

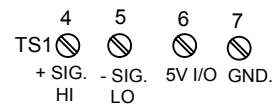

NOTE: OPTION N INCLUDES 0.04 OHM 5W SHUNT AT TERMINALS 4 & 5

Option U: %RH: This conditioner is designed to interface to a typical (capacitance type) 2-3pF/% of **RH** made by several manufacturers. Use Option "09" and contact **OTTEK** to specify your sensor's specifications.

CONNECTIONS:

FIG. LPE-1
OPTIONS 1-7, C-N, T-V
EXTERIOR POWERED

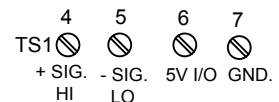

NOTE: OPTION N INCLUDES 0.04 OHM 5W SHUNT AT TERMINALS 4 & 5

LPE continued

Option V: pH (Acidity): We use a FET input (1015) amplifier and calibrate the **LPE** for 0-14.00 pH using the Industry's standard + 413 mV = + 7pH co-efficient.

Accuracy: +0.05% of F.S

CONNECTIONS:

FIG. LPE-1

OPTIONS 1-7, C-N, T-V
EXTERIOR POWERED

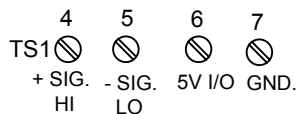

NOTE: OPTION N INCLUDES 0.04 OHM 5W SHUNT AT TERMINALS 4 & 5

Option W: ORP(Oxygen Reduction Potential): Our FET amplifier (109) accepts the industry standard 2000mV F.S. of the probe and the **LPE** displays it in % (0-100.00%)

CONNECTIONS:

FIG. LPE-1

OPTIONS 1-7, C-N, T-V
EXTERIOR POWERED

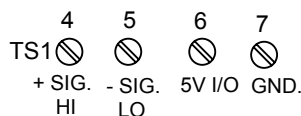

NOTE: OPTION N INCLUDES 0.04 OHM 5W SHUNT AT TERMINALS 4 & 5

Option X: Hi Speed Peak & Hold (P&H): Now you can capture fast transients greater than 50 microseconds (even faster soon) with resolution greater than 0.1% of F.S. and retention of greater than 10 years (Due to OTEK's new and patent-pending **P&H Option**).

CONNECTIONS:

FIG. LPE-X

OPTION X

HIGH SPEED PEAK AND HOLD

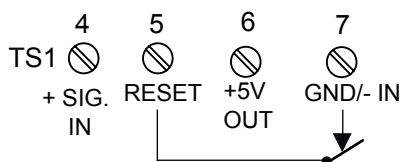

Input: V or mADC (Specify Range). Contact **OTEK** for V/mA RMS or Loop Powered).

Accuracy: +/- 0.1% of F.S. +/- 1 Digit

Linearity & Resolution: +/- 0.1% of F.S.

Response time: >20KHz (<50us)

Retention: >10 years (with power on).

Option Y: Signal Powered for VAC:

No power supply req'd! Just connect to your P.T.(no-isolation) and display the value. Ideal for Analog meter replacement, range: 40-150VAC, 50-400Hz. Burden 0.1W, Accy.& Lin. :+/- 0.5% of F.S. Note: Digits 5 & 6 must be option 0.

CONNECTIONS:

FIG. LPE-8/Y OPTIONS 8/Y
VAC OR HZ SIGNAL POWERED

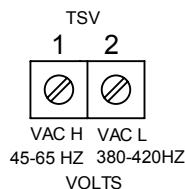

Option Z: Signal Powered Amps

AC: No Power Supply Req'd! Just connect to your P.T. range: 0.5-5Amp; 50-400Hz; burden; 0.1W Accy. & Lin.; +/- 0.5% of F.S.

Note: Our internal C.T. isolates your C.T. and powers the **LPE**. Note: Digits & 6 must be option 0.

CONNECTIONS:

FIG. LPE-Z OPTION Z
AMPS SIGNAL POWERED

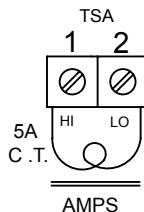

ABOUT AC POWERLESS TECH-

NIQUE: As with analog meters, the AC signal power models have a minimum signal input for illumination. For voltage or frequency, the minimum input signal is 40 VAC. For current, the minimum input signal is 0.5 AAC. See other options for externally powered models.

More: New Signal Conditioners will be added as per your requests and popularity, such as Ohms, Conductivity, Shock, Vibration, Position etc. Contact **OTEK**.

POWER/INPUT (Digit 3):

OPTIONS 1 & 2: NON-ISOLATED VDC POWER: All listed I/O options (except Powerless™) are available. Power requirements vary with options included. The basic **LPE** requires under 150mW (30 mA@5VDC). Fully Loaded: 1 watt. Confirm power input (Digit 3) before connecting. V+: TS1-12; V-:TS1-11.

OPTION 3: USB POWER: VBUS: TS1-12; Ground: TS1-11; D+: TS1-9, D-TS1-8

OPTIONS 4,5 & 8: ISOLATED POWER: These options offer minimum isolation of 500 VAC or DC and their efficiency is about 80%. All power input ranges are +/-10%.

ACHi/V+: TS1-12; ACLo/V-: TS1-11

Serial I/O: Digit 5, Options 1-4:

TXD: TS1-9; RXD: TS1-8, Ground: TS1-1 or see user's manual at www.otekcorp.com.

Power For Transmitter, Digit 6,

Options 1-4: Only available for Powered models (Digit 3, options 1-8). We convert the internal 5VDC to 28VDC to power your transmitter. Maximum output: 25mA. Power consumption: 1 Watt@5VDC (200mA)

LPE STANDARD CONNECTIONS

(No Serial I/O)

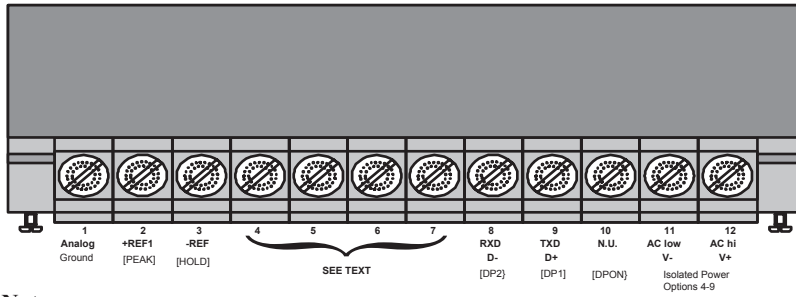

NOTE: 1=OPEN; 0=CONN. TO TS1-1; X=N/A

DEC. POINT	DP0N	DP1	DP2	PEAK TS1-2	HOLD TS1-3
NONE	0	X	X	X	X
1.XXXX	1	1	1	X	X
1X.XXX	1	1	0	X	X
1XX.XX	1	0	1	X	X
1XXX.X	1	0	0	X	X
PEAK	X	X	X	0	1
HOLD	X	X	X	1	0

Only for Option 0 on Digit 5, others via Serial I/O

Notes:

1. Confirm power input (Digit 3) before connecting.
2. DP1 & 2 only for option 0 on Digit 5.
3. Serial I/O only for options 1-4 on Digit 5.
4. Do NOT connect to TS1 for Options 8, B, Y & Z (high voltage).

LPE MECHANICAL INFORMATION

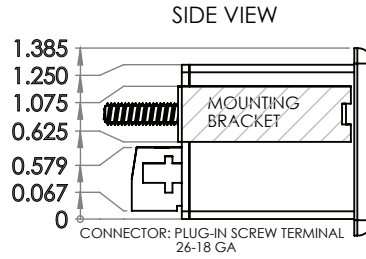
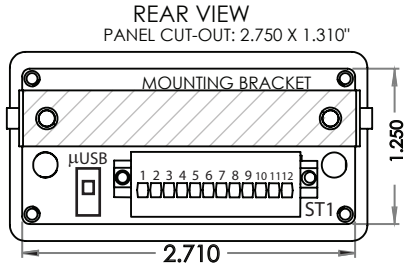
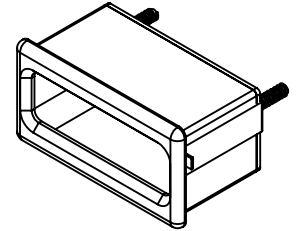
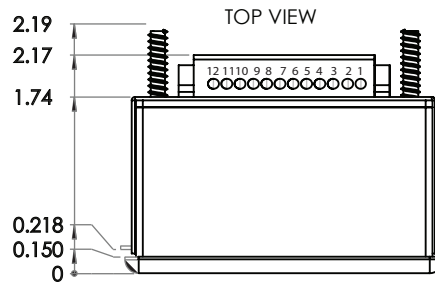
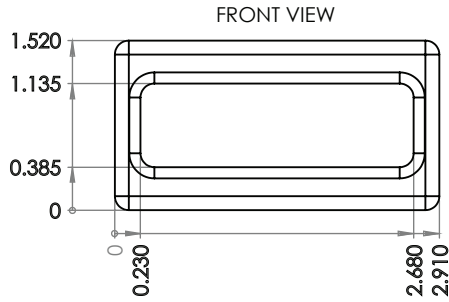

PANEL CUT-OUT
2.75"x1.30"

SANITARY

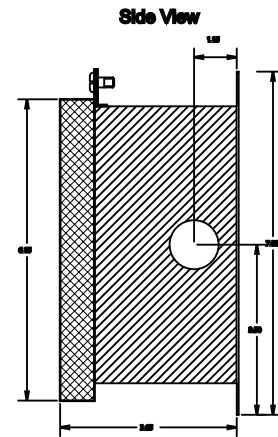
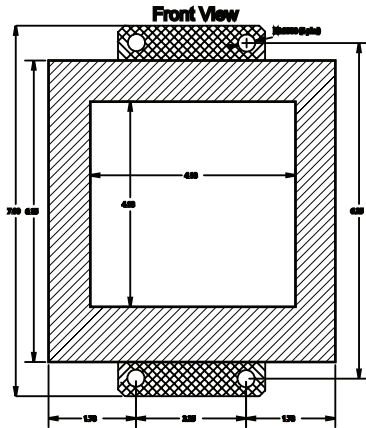

NOTES:

1. Do Not Connect To Pins 1, 2 & 3 (For Special Functions Only)
2. Standard Serial I/O Settings are 8N1. 9600Kb Baud Rate, Address and Decimal Point are serially programmable.

For Loop Powered Just Connect "+ Loop" to Pin 6, "-Loop" to Pin 7. All Others See User's Manual at www.otekcorp.com.

LPE SERIES ORDERING INFORMATION 5-7-13

NOTES: Please READ BEFORE building part number:

1. If digit 2 is option 0 or A, then digit 3 must be option 0, digit 5 must be option 0 or 1 and digit 6 must be option 0.
2. If digit 2 is option 8, B, Y or Z, then digits 3, 5 and 6 must be 0.
3. If digit 3 is option 3, then digit 5 must be option 4.
4. See notes on bottom of page.

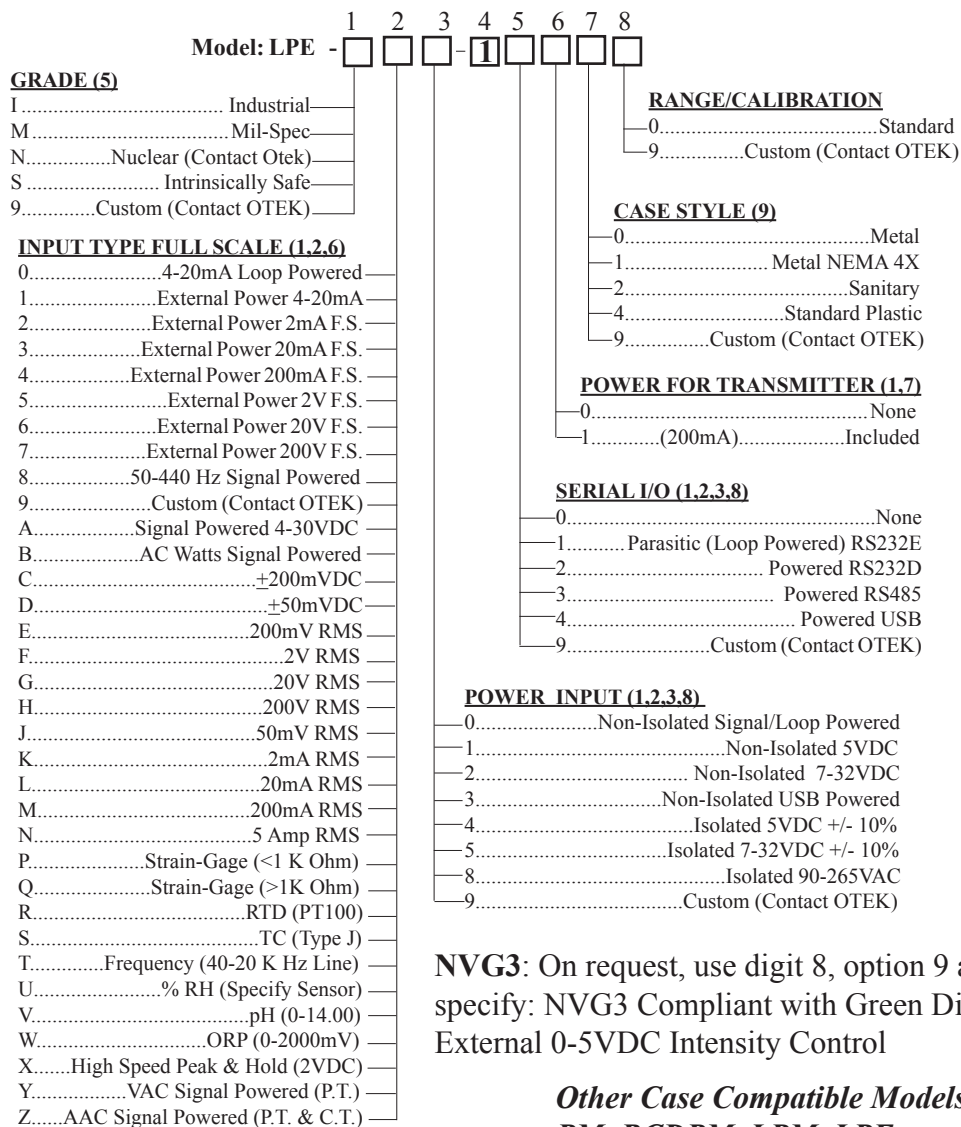

NVG3: On request, use digit 8, option 9 and specify: NVG3 Compliant with Green Display and External 0-5VDC Intensity Control

***Other Case Compatible Models:
PM, BCDPM, LPM, LPE,
HI-QREM***

NEW: 2-500 VDC Multirange! Use #9 on 2nd digit & specify multirange.

DOWNLOADS: For manuals, user-software or drivers:
www.otekcorp.com

NOTES (Continued):

5. Contact OTEK for M, N & S grades. **“Intrinsicly Safe”** version is compliant by design only. No certificate available until further notice. Otek will build to certain nuclear or MIL-standards but testing and confirmation of compliance, if required, will need to be done by a third party and at customer's expense.
6. Option S must specify range of interest within 300° (F or C) span. Contact OTEK for other RTD/TC types. For powerless AC Watts use option 9 and specify.
7. Power for transmitter (28VDC@20mA) NOT available with powerless input.
8. Only RS232E is available with Signal Powered, others powered. Must have serial I/O to implement command functions (if required).
9. Maximum of 3 units inside sanitary case. If using more than 1 unit in a sanitary case, select Option 9 (Custom) and describe.