

**WORLD'S
FIRST**

**LOOP POWERED "SWITCHBOARD" BARGRAPH
FOR MIL-SPEC, NUCLEAR AND
HI-REL INDUSTRIAL APPLICATIONS
WITH >20 SIGNAL CONDITIONERS**

**MODEL
LSB**

FEATURES:

- Loop or VDC/A.C. Signal Powered
- Serial I/O
- 101 Bars & 4 1/2 Digits LCD Display
- Alarms & 4-20mA Out
- Bi-Polar With Center Zero
- Optional Automatic Tricolor Backlight
- Fits 3.375" & 90mm Cutout
- Replaces Any Analog Loop Powered Meter
- Power For Transmitter
- Lifetime Warranty



Reading Within Limits (Green Backlight)



Reading Within Limits (No Backlight)

DESCRIPTION

In 1975 **O TEK** introduced the World's First Loop Powered DPM. In 1979, The First Loop Powered Bargraph. In 1996 the automatic tri-color bargraph and in 2004 the world's first loop powered serial I/O DPM. Now **O TEK** brings you the *World's First Loop or A.C. Signal Powered Bargraph* (Pat. # 7,626,378 & 4,908,569). The bargraph gives you trend and digital accuracy.

DISPLAYS:

The **LSB** has 101 segments (bars) and can be loop powered or externally powered, with or without automatic tricolor backlight. The **LSB** is fully configurable for many functions (See User's Manual at www.otekcorp.com. Standard calibration and configuration (unless otherwise specified) is:

- a. Left Zero, 4-20mA or 0-2V = 0 - 100.0 & 0-100 bargraph segments.
- b. Alarm Annunciators (bars only reverse acting) set for: 10, 20, 80 & 90% of Scale.
- c. Backlight: Red: 0-10%, Amber: 10-20%, Green: 20-80%, Amber: 80-90%, Red: 90-100%. But, if you need to change it, just plug a hand held terminal into the Com connector on the back of the unit.

LOOP POWERED: Use it to monitor or control any process and if you enable the backlite colors, it will inform the operator of limits exceeded. If you use the serial port it will communicate with other intelligent instruments (DCS, SCADA, PC, PLC, etc.) or even become a remote display.

A.C. SIGNAL POWERED: No power supply is required! The LSB draws its parasitic power (~25mA) from the signal it measures. Again backlite colors and RS232E are available to help you control the process. **WARNING:** No isolation; use P.T. and C. T. (no control outputs).

EXTERNALLY POWERED: Here you have access to ALL the LSB's features such as relays, analog out, USB, RS232C, RS485, math functions, X-Y tables, polynomials, floating point and more.

GRADES: Nuclear: For Class 1E; Mil: To specific Mil-Stds; Industrial: Per these specifications.

OTHER BARGRAPHS: SEB, LPB, LBD, EBD, 123-127 HIQ Series.

**IF YOU DON'T
SEE IT ASK FOR IT!**



520-748-7900

FAX: 520-790-2808

E-MAIL: sales@otekcorp.com

<http://www.otekcorp.com>

O TEK TM **CORP.**
SINCE 1974

4016 E. TENNESSEE ST.
TUCSON, AZ. 85714 U.S.A.

MADE
IN
USA



LSB Series continued

HOW IT WORKS:

CURRENT LOOP POWERED:

We use a Zener to clamp the voltage to 5V max. and monitor the Loop's current (we invented it in 1974). (Digit 2, Option 0).

VDC SIGNAL POWERED: We monitor the voltage with high impedance and clamp it to a safe level to power the **LSB**. (Digit 2, Option 2).

AC SIGNAL POWERED: For VAC & Hz we use a capacitor limiting rectifier to power the **LSB** and monitor the VAC with an RMS-DC converter. For Hz we use an F-V for accurate conversion. For A.A.C. we invented (Patented) a C-V converter to extract the current from your C.T. for power and monitor the signal with RMS-DC. (Digit 2, Options Q-T). ~50 mW.

EXTERNALLY POWERED: Non-Isolated 5VDC or isolated 5-36VDC or 90-265VAC 50/60Hz is optional (Digit 3, Options 1-8). Max Power: 0.1 Watt, plus options.

DISPLAY (DIGIT 4): Stand 0-F.S. in=0-100% and 0-10,000 counts, or use #9 and specify (configurable).

SERIAL I/O: When ordered, (Digit 5), the **CPU** controls the Baud Rate (300-9600 Baud), the relays, analog output, math functions, linearization polynomial (9th) & X-Y tables.

CONTROL & POWER OUT (DIGIT 6): (Not for powerless models).

You can order 4-20mA as standard, or 0-5V, 0-20mA or 0-24mA on request, or you can order the isolated 30VDC (30mA) or Non-Isolated 28VDC out for your transmitter.

See ordering information for power consumption of each option.

CONTROL & POWER OUT (DIGIT 6): (Continued)

RELAYS/O.C.T.: Either four (4) relays (SPDT) rated contacts at 1A@120 VAC resistive, with ~500mS response; with built in varistors or 4 open collector transistors rated at 30 VDC/30mADC common emitter, with < 500mS response.

THE SIGNAL CONDITIONERS: 2ND DIGIT) OPTION 0: 4-20MA LOOP POWERED:

First introduced in 1975, the current flows through a Zener and "Shunt" resistor. The Zener clamps the voltage to about 5 Volts and the voltage across the Shunt is measured and displayed. If the "burden" (3.5 - 4.5V) is too high for your application, use the externally powered version.

Accuracy: ±0.1% of F.S.

CONNECTIONS:

FIG. LSB-0, LOOP POWERED

- TS2
- 1 ⊗ + LOOP
- 2 ⊗ - LOOP
- 3 ⊗ N.C.
- 4 ⊗ N.C.

OPTION 1 4-30VDC SIGNAL POWERED:

Another **OTEK** innovation. The voltage signal powers an **LDO** to protect the **LSB** and a divider network is used to measure and display the signal. If the input resistance of this Option is too low (~ 500 Ohms), use powered models. Power input must be Option 0 (Powerless).

Accuracy: ±0.1% of F.S. Power consumption is ~250mW.

CONNECTIONS:

FIG. LSB-1, 4-30V IN

- TS2
- 1 ⊗ + SIG.
- 2 ⊗ - SIG.
- 3 ⊗ N.C.
- 4 ⊗ N.C.

OPTION 2: 4-20MA EXTERNALLY POWERED:

It only drops 1.0V @ 20mA (50 Ohms) but the "**LSB**" needs 5VDC @ 20mA to operate (including the backlight or LEDs). Power Input must be Options 1-8, or 9".

Accuracy: ±0.05% of F.S.

CONNECTIONS:

FIG. LSB-2-B, G, H, L-N

- TS2
- 1 ⊗ + SIG.
HI
- 2 ⊗ - SIG.
LO
- 3 ⊗ N.C.
- 4 ⊗ N.C.

OPTIONS 3-6: VDC & MADC EXTERNALLY POWERED:

Input impedance is 1 Mega Ohms on all VDC ranges and 100 Ohm on 2mA and 1 Ohm on 200 mA range.

Accuracy: ±0.05% of F.S.

CONNECTIONS:

FIG. LSB-2-B, G, H, L-N

- TS2
- 1 ⊗ + SIG.
HI
- 2 ⊗ - SIG.
LO
- 3 ⊗ N.C.
- 4 ⊗ N.C.

OPTIONS 7, 8 & A:

V & mA RMS: Here we use a **True RMS-DC** Converter for accurate (± 0.05%) measurement of sine waves up to 10KHz (± 0.1% for 10-20KHz) and SCR;s fired to ± 1%. Input impedances vs. range are the same as for VDC & mADC ranges. **Warning: No Isolation!**

Accuracy: ±0.1% of F.S.

CONNECTIONS:

FIG. LSB-2-B, G, H, L-N

- TS2
- 1 ⊗ + SIG.
HI
- 2 ⊗ - SIG.
LO
- 3 ⊗ N.C.
- 4 ⊗ N.C.

LSB Series continued

OPTION 9: CUSTOM: Use this option to describe any custom input, scale or modification to the **LSB** and contact us for feasibility and cost.

OPTION B: 5AMPS AC:

Specifically for current transformers (**C.T.**) this option requires an externally mounted (supplied) 0.05 Ohm, 0.1% 5 Watt resistor. You can mount the "Shunt" at your **C.T.** or next to the **LSB** but make sure the connections are "Perfect" to electrical codes. The C.T. might have "**Lethal! High Voltage**" without a "Shunt" (Open) and the **LSB** will "Smoke". See OTEK's New **ACS & CTT** models for **C.T.** powered instruments (Patented) or us Option R.

Warning: No Isolation!

Accuracy: ±0.05% of F.S.

**CONNECTIONS:
FIG. LSB-2-B, G, H, L-N**

- TS2
- 1 ⊗ + SIG.
HI
- 2 ⊗ - SIG.
LO
- 3 ⊗ N.C.
- 4 ⊗ N.C.

OPTION C: STRAIN-GAGE

(**<1000 Ohm Type**): Here we use a highly accurate and stable constant current (~1 mADC), and a differential amplifier to convert the 2 or 3mV/V (typical) sensitivity of your "Load-cell". **Specify** your Strain-Gage sensitivity and full scale and the **LSB's** display at Zero and Full Scale Please!

Accuracy: ±0.05% of F.S.

**CONNECTIONS:
FIG. LSB-C/D (S-G)**

- TS2
- 1 ⊗ + S
- 2 ⊗ - S
- 3 ⊗ + E
- 4 ⊗ - E

OPTION D: STRAIN-GAGE (≥1K < 5K Ohm): These are typically "Monolithic" **S-G** that require constant voltage (preferably) excitation. We use 4.096V for high stability and accuracy. **Specify** your S-G impedance and sensitivity and the **LSB's** display at Zero and Full Scale.

Accuracy: ±0.1% of F.S.

Note on S-G: Some S-G offer +/- 1VDC or 4-20mA condition output. Use Option 9 and specify.

**CONNECTIONS:
FIG. LSB-C/D (S-G)**

- TS2
- 1 ⊗ + S
- 2 ⊗ - S
- 3 ⊗ + E
- 4 ⊗ - E

Option E: RTD (PT100): We excite your 2, 3 or 4 wire RTD with 200µA to avoid the "self heating" effect. The range of the **LSB** is the same as your **RTD** typically -200°C to +800°C (-328 + 1562°F). You can place the decimal point at will (typically -200.0 to 800.0 (-328.0 to 1562.0)). The **PT100** has a temperature coefficient of 0.00385 Ohms/Ohm/°C. To change from °C to °F or PT100 to ANSI 392, use serial commands.

Accuracy: ±0.5% of F/C plus sensor's error.

Note: For 2 wire, jump - S to -E and +S to +E. For 3 wire only jump -S to -E.

**CONNECTIONS:
FIG. LSB-E/F (RTD)**

- TS2
 - 1 ⊗ + S
 - 2 ⊗ - S
 - 3 ⊗ + E
 - 4 ⊗ - E
- FOR 3 WIRE, JUMP 1 & 2
FOR 2 WIRE, JUMP 1 & 2
AND 3 & 4

OPTION F: RTD (PT1000): Same as PT100 except it is 1000 Ohms at 0°C instead of 100 Ohms @ 0°C. The same technique is used. For copper **RTD** (10 Ohm), contact **OTEK**. Same connection as Option E apply.

Accuracy: ±0.5% of F/C plus sensor's error.

Note: For long distances use a 4-20mA transmitter such as our 900 or LPT series.

**CONNECTIONS:
FIG. LSB-E/F (RTD)**

- TS2
 - 1 ⊗ + S
 - 2 ⊗ - S
 - 3 ⊗ + E
 - 4 ⊗ - E
- FOR 3 WIRE, JUMP 1 & 2
FOR 2 WIRE, JUMP 1 & 2
AND 3 & 4

OPTIONS G&H: FREQUENCY INPUT:

We use an **F-V** to accept frequencies from 40 - 20KHz and amplitudes from 1-400V peak or dry contact or open collector transistor (O.C.T.). For 50 or 60Hz power line frequency measurement, use Option H or S.

Accuracy: ±0.05% of F.S.

**CONNECTIONS:
FIG. LSB-2-B, G, H, L-N**

- TS2
- 1 ⊗ + SIG.
HI
- 2 ⊗ - SIG.
LO
- 3 ⊗ N.C.
- 4 ⊗ N.C.

LSB Series continued

OPTION J: THERMOCOUPLE

(TYPE J): This **TC** has a range of -210 to + 760°C (-350 + 1390°F). Its color is white (+) and Red (-), cold junction (CJ) is inside the **LSB** at the connector base. Make sure the connections from the **LSB** and your **TC** are as close to the **LSB's** terminals as possible to avoid errors. If you short out the **LSB's** +**TC** & -**TC** together, the **LSB** will read the ambient temperature due to its C.J.C. (Cold Junction Compensation).

NOTE: You can change from °C to °F and TC type via simple commands on serial port.

Accuracy: ± 2⁰ F/C of signal input.

**CONNECTIONS:
FIG. LSB-J/K (TC)**

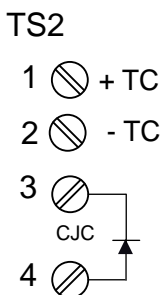

CJC INCLUDED

OPTION K: TC (TYPE K): This is amber (+) and red (-) and has a range of -270 + 1370°C (-440 + 2500°F). The same notes as Option J.

Accuracy: ± 2⁰ F/C of signal input

For Other TC use #9 and Specify.

**CONNECTIONS:
FIG. LSB-J/K (TC)**

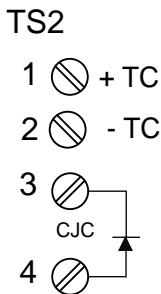

CJC INCLUDED

OPTION L: %RH: This conditioner is designed to interface to a typical (capacitance type) 2-3pF/% of **RH** made by several manufacturers. Use Option 9 and contact **OTEK** to specify your sensor's specifications.

Accuracy: ± 2% RH of signal input.

**CONNECTIONS:
FIG. LSB-2-B, G, H, L-N**

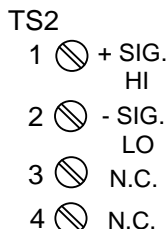

OPTION M: pH (ACIDITY): We use a FET input (10¹⁵) amplifier and calibrate the **LSB** for 0-14.00 pH using the Industry's standard ± 413 mV = ± 7pH coefficient. Bargraph display is 0-100% or use Option 9 and specify.

Note: Not temperature compensated.

Accuracy: ±0.05% of F.S.

**CONNECTIONS:
FIG. LSB-2-B, G, H, L-N**

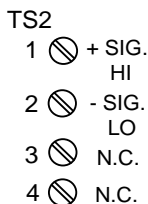

OPTION N: ORP (OXYGEN REDUCTION POTENTIAL): Our FET amplifier (10⁹) accepts the industry standard 2000mV F.S. of the probe and the **LSB** displays it in % (0-100.00%).

Accuracy: ±0.05% of F.S.

**CONNECTIONS:
FIG. LSB-2-B, G, H, L-N**

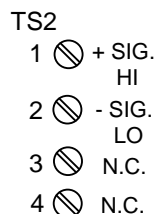

OPTION P: HI SPEED PEAK & HOLD (P&H): Now you can capture fast transients greater than 5 microseconds (even faster soon) with resolution greater than 0.1% of F.S. and retention of greater than 10 years (Due to OTEK's new and patent-pending **P&H Option**).

INPUT: 2VDC/mADC F.S. or mADC (Specify Range). Contact OTEK for V/mA RMS or Loop Powered.

ACCURACY: +/- 0.1% of F.S. +/- 1 Digit

LINEARITY & RESOLUTION: +/- 0.1% of F.S.

RESPONSE TIME: >200KHz (<5us)

RETENTION: >10 years (with power on)

**CONNECTIONS:
FIG. LSB-P (P & H)**

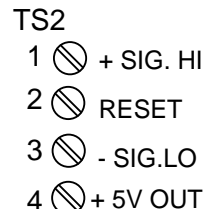

RUN: JUMP 3 & 2
RESET: PULSE 3 & 1 or OPEN 3 & 2
PIN 3 HAS 10K PULL UP TO +5V

LSB Series continued

Note: Options Q-T only available with Powerless™ Signal power input (Option 0). (Pat. # 4,908,569)

Option Q: VAC Signal Powered: Warning! No Isolation! This option uses the AC Voltage Signal to power the **LSB**. Since the **LSB** uses about 30mA @ 5VDC, we use a coupling capacitor AC-DC converter to generate 5VDC and not to "Load the signal with a transformer. Consequently, your signal source should be capable of producing about 150mW without overloading it, otherwise use Options 7 or 8 (externally powered). Range: 50-150VAC; Method: RMS Calibrated; Accuracy & Linearity: $\pm 0.5\%$ of F.S. Best and safest when driven by a P.T. (Potential Transformer. *Always turn power off before connecting!*

**FIG. LSB-Q/T
TYPICAL CONNECTIONS
FOR INPUTS Q, R, S & T
AC POWERLESS™**

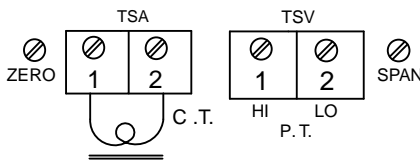

Option R: AAC Signal Powered: Warning! No Isolation! (Pat.# 7,626,378)

OTEK's Patented technique permits the extraction of power from a regular **C.T.** (Current Transformer) to power the **LSB** without distorting the signal. Since this option is designed to be powered from a C.T., it should not be connected directly to the mains without limiting the current and proper electrical grounding. **Lethal Voltage** might be present at the C.T. secondary (output) if the secondary is open.

Always turn power off before connecting! Range (at C.T. output): 0.1-5AAC; Overload: 50%/30 seconds; Peak: 100%/1 second; Conversion: True RMS; Accuracy & Linearity: $\pm 0.05\%$ of F.S.; Burden on C.T.: <150mW.

Option S: Hertz (Line Frequency) Signal Powered: Warning! No Isolation! This option uses the same power

technique as Option Q above and the same precautions and warnings apply. Here we use a "Zero Crossing" detector and a F-V converter to give you the **A.C.** line frequency display with 0.1 Hz resolution.

Range: VAC: 50-150VAC/Frequency: 30-100Hz. Accuracy & Linearity: $\pm 0.5\%$ of F.S.

For 400 Hz line use #9 and specify range.

Option T: Signal Powered AC Watts:

Warning! No Isolation! Here we combine the powerless VAC & AAC options to arrive at real power calculations through our **CPU** and **DAC**. The same warnings and precautions of Options Q & R apply. Range: VAC: 50-150; AAC: 0.1 - 5A; Frequency: 40-450Hz; Accuracy & Linearity: $\pm 0.1\%$ of F.S.; Conversion: True RMS. Hz: 45-65.

POWER/INPUT (DIGIT 3):

OPTION 0: POWERLESS™: The **LSB** is powered from the signal that it measures. **ONLY** available for options 0, 1, and Q through T of input signal (Digit 2).

WARNING: Any other I/Os are **NOT** isolated from signal. Options Q-T (Digits 2 & 3) could have lethal potentials!

OPTION 1: NON-ISOLATED 5 VDC POWER:

All listed I/O options (except Powerless™) are available. Power requirements vary with options included. The **LSB** with No Control or Power Out (Digit 6, Option 0) requires under 150 mW (30 mA@5VDC). Please add all the options power to the basic **LSB**. (See ordering information)

OPTIONS 6-8: ISOLATED POWER

These options offer minimum isolation of 500 VAC or DC and their efficiency is about 80%. Again, add all the options. See ordering information.

DISPLAY (4TH DIGIT): Standard display is 0-F.S. input=0-100% and 0-1000 counts. Any other, use #9 and specify. Also, see digit #9 for scale plate printing.

SERIAL I/O (5th Digit): WARNING: No Isolation From Signal.

OPTION 1: Parasitic RS232E. Only for powerless models (Option 0 on 3rd digit).

OPTION 2: RS232D: 1200-19.2kb, all ASCII (8N1) open protocol "DB9."

OPTION 3: RS485: 1200-19.2kb, all ASCII (8N1) open protocol screw "connector."

OPTION 4: USB: 1200-19.2kb, all ASCII (8N1) open protocol, "USB Type B" connector.

Any terminal program (Hyperterminal, Procomm, Kermit) will work with OTEK's serial com. ports. For USB download out Driver at www.otekcorp.com.

LSB Series continued

CONTROL & POWER OUT

(DIGIT 6): (Only Powered Models)

OPTION 1: RELAYS (4): SPDT, 1A@120VAC or 30 VDC resistive. Varistors (250V) included. Settable via serial port as alarms. Response time: ~500mS, silver contacts. Power required: 50mA@5VDC/relay. mW.

OPTION 2: OPEN COLLECTOR TRANSISTORS (O.C.T):

Four O.C.T are included and all are common emitter (sinking) to digital ground. The 5 VDC internal power is available. Maximum current allowed per O.C.T. (From the internal 5 VDC) is 20mA/O.C.T. if external VCC is used, the maximum VCE is 30 VDC and 30 mA per O.C.T. Switching time is under 500ms.

OPTION 3: ISOLATED 4-20 MA (RETRANSMISSION): (ONLY POWERED MODELS)

This option is offset & scaled via the serial port (digit 5) and can be configured for 4-20, 0-20 or 0-24 mA or 0-5 VDC via internal jumpers (standard is 4-20 mA). This option requires under 200 mA@5VDC internal power. Accuracy & linearity is +/- .1% of setting and can drive up to 1K ohms load.

Also see Option B. Power consumption: 200mA@5VDC.

OPTION 4: ISOLATED 30 VDC

You can use it to excite your transmitter at up to 25mA. It consumes under one (1) watt at full load. Also see Option E. Power consumption: 200mA@5VDC.

OPTION 5-8: Combinations of Option 1-4.

Don't forget to add all power requirements of each option desired. Worst Case: 2 watts max.

OTHER SPECIFICATIONS

- Bars: 101 & 4 1/2 Digits (19999)
- Digits (5) & Annunciators (4): 0.4" High
- Power For Transmitter: 28VDC@20mA (requires 1 Watt Power Input)
- Input Type: Differential & Single Ended. 1M Ohms For VDC
- All Configurations via Serial Port For Added Security
- 5VDC Powered: 40mA @ 5V
- Zero & Span Adjustments: On Rear (See Note 5) or Via Serial Port
- Z in For V: 1 MEG Ohms
- Z in For mA: See Ordering Information on Digit 2.

GRADES: 4 grades are available, all with the same high reliability and tested for:

I Industrial, **M** to specific Mil-Specs, **N** Nuclear to 10CFR50B and **S** Intrinsically Safe for Class I Div. 1.(See Note 1) Contact **OTEK** for more details.

HOUSINGS: Either plastic, metal, explosion proof or sanitary to 250°F Steam cleaning.

ENVIRONMENTAL:

- Op/Storage Temp.: -10 + 70°/-20 + 80°C
- Humidity: 5-95RH Non-Condensing
- MTBF: >100,000 Hours

LSB SERIES continued

TYPICAL CONNECTIONS

For Digit 2, Options 1-P; For Digit 3, Options 1-8 and Digit 6, Options 0-E
"Powered" Only

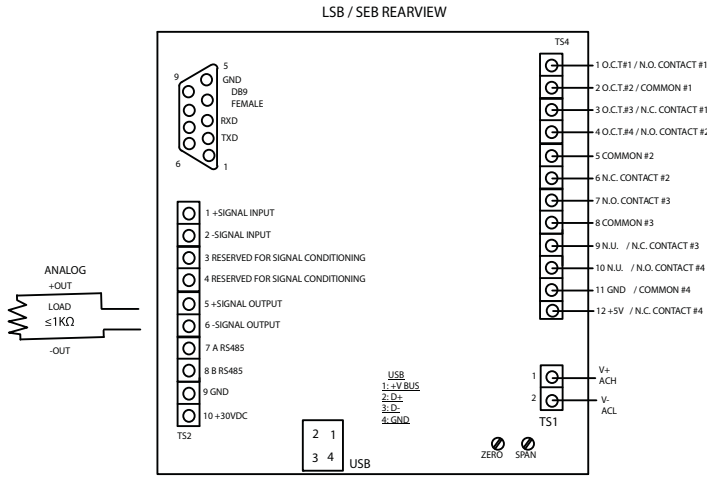

NOTE: SEE FIG. SEB-5 FOR MODELS W/O CONTROL OUTPUT

TYPICAL CONNECTIONS

A. C. Powerless™
 Digit 2, Options 1, Q, R, S & T Only
 Digits 3 & 6, Option 0

FIG. SEB-5 CONNECTIONS (FOR SEB/LSB/LPB)

- NOTES:**
- 1.) DON'T CONNECT UN-NAMED TERMINALS
 - 2.) CONFIRM P/N BEFORE CONNECTING
 - 3.) ALWAYS ADJUST ZERO BEFORE SPAN
 - 4.) DON'T REMOVE FACTORY JUMPERS
 - 5.) TS2 ONLY FOR ISOLATED POWER IN
 - 6.) TS1-3 THRU TS1-6 FOR SIGNAL INPUT
 - 7.) TS1-7 THRU TS1-9 FOR SERIAL ONLY
 - 8.) USE THIS FOR MODELS LSB OR SEB-XXX-XX0-XXX (NO CONTROL OUTPUTS) & SEE INPUT SIGNALS TYPICAL CONNECTIONS

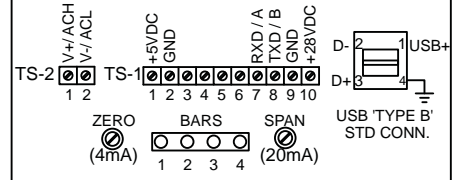

NOTES: FOR SEB/LSB MODELS WITH CONTROLLING OUTPUTS (SEB/LSB-XXX-XX1/8-XXX) SEE FIG. SEB-4

LSB MECHANICAL INFORMATION

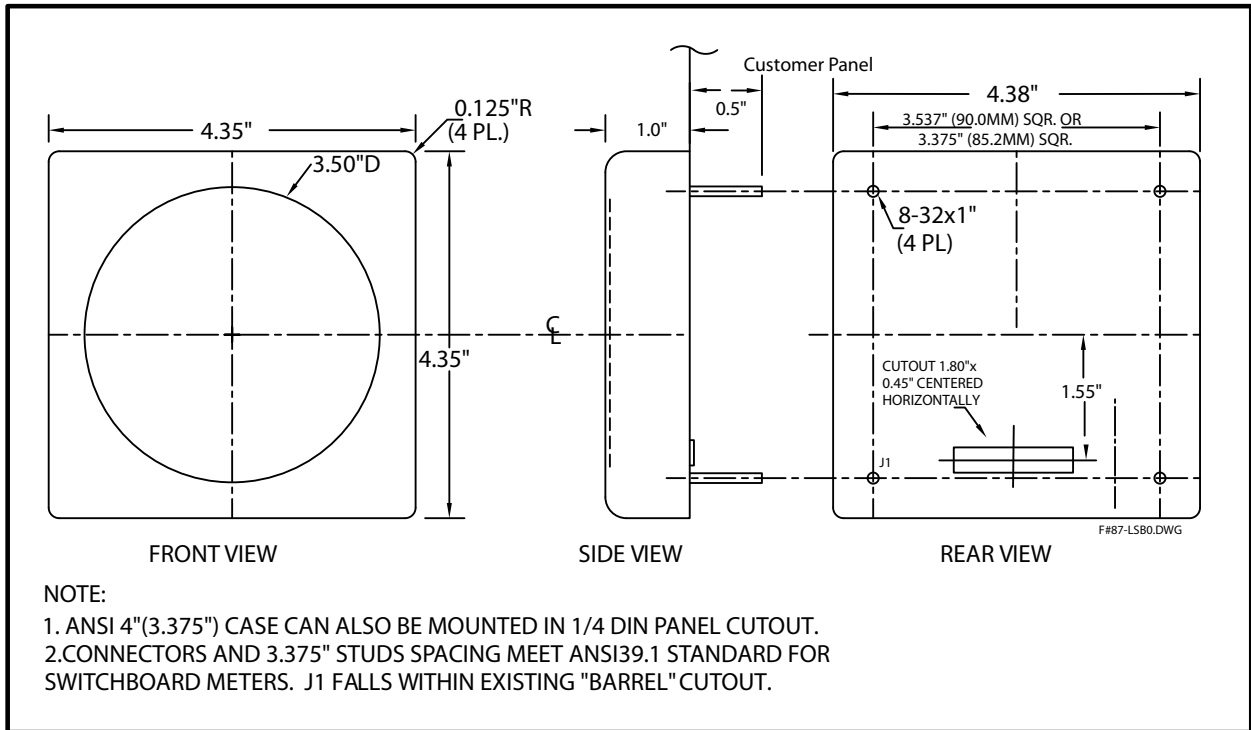

NOTE:

1. ANSI 4" (3.375") CASE CAN ALSO BE MOUNTED IN 1/4 DIN PANEL CUTOUT.
2. CONNECTORS AND 3.375" STUDS SPACING MEET ANSI 39.1 STANDARD FOR SWITCHBOARD METERS. J1 FALLS WITHIN EXISTING "BARREL" CUTOUT.

NOTE:

1. ANSI 4" (3.375") Case Can Also Be Mounted In 1/4 DIN Panel Cutout.
2. Connectors and 3.375" Studs Spacing Meet ANSI 39.1 Standard For Switchboard Meters. J1 Falls Within Existing "Barrel" Cutout.

LSB ORDERING INFORMATION (9-2-16)

NOTES: Please READ BEFORE building part number:

1. If digit 2 is option 0 or 1, then digit 3 must be option 0, digit 5 must be option 1 and digit 6 must be option 0.
2. If digit 2 is option Q-T, digits 3, 5 & 6 must be option 0.
3. If digit 3 is option 7, then digit 5 must be option 4.
4. See notes on bottom of page.

Model: LSB-	1	2	3	4	5	6	7	8	9
<p><u>GRADE (5)</u></p> <p>I.....Industrial</p> <p>M.....Mil-Spec</p> <p>N.....Nuclear (Contact OTEK)</p> <p>S.....Intrinsically Safe</p> <p>9.....Custom (Contact OTEK)</p> <p><u>F.S. INPUT SIGNAL/Z in (1,2,6,9,12)</u></p> <p>0.....4-20mA Loop Powered</p> <p>1.....4-30VDC Signal Powered</p> <p>2.....4-20mA External Powered</p> <p>3.....200mVDC/1M Ohms</p> <p>4.....500 VDC/1M Ohms</p> <p>5.....2mADC/100 Ohms</p> <p>6.....200mADC/1 Ohms</p> <p>7.....200mVRMS/1M Ohms</p> <p>8.....500VRMS/1M Ohms</p> <p>9.....Custom (Contact OTEK)</p> <p>A.....2mARMS/100 Ohms</p> <p>B.....5ARMS/0.05 Ohms</p> <p>C.....Strain Gage<1000 Ohms</p> <p>D.....Strain Gage>1000 Ohms</p> <p>E.....RTD PT100 (100 Ohms)</p> <p>F.....RTD PT1000 (1K Ohms)</p> <p>G.....Frequency 40-20 KHz</p> <p>H.....Frequency 50-60HZ Line</p> <p>J.....TC Type J</p> <p>K.....TC Type K</p> <p>L.....% RH (Specify Sensor)</p> <p>M.....pH (0-14.00)</p> <p>N.....ORP (0-2000 mV)</p> <p>P.....High Speed Peak & Hold, 2 V</p> <p>Q.....VAC Signal Powered (P.T.)</p> <p>R.....AAC Signal Powered (5A C.T.)</p> <p>S.....40-70 Hertz Signal Powered (P.T.)</p> <p>T.....Watts AC Signal Powered (P.T. & C.T.)</p> <p>U.....None (Remote Display/Control)</p> <p><u>POWER INPUT (1,2,3,8,11)</u></p> <p>0.....Signal/Loop Powered</p> <p>1.....Non-Isolated 5VDC</p> <p>6.....Isolated 90-265VAC</p> <p>7.....Non-Isolated USB Powered</p> <p>8.....Isolated 10-32VDC</p> <p>9.....Custom (Contact OTEK)</p>	<p><u>RANGE/CALIBRATION (10)</u></p> <p>0.....Standard</p> <p>9.....Custom (Contact OTEK)</p> <p><u>SCALE PLATE</u></p> <p>0.....Standard 0-100%</p> <p>9.....Custom (Contact OTEK)</p> <p><u>HOUSING & MOUNTING</u></p> <p>0.....Plastic & 3.375"</p> <p>1.....Plastic & 90mm</p> <p>2.....Metal & 3.375"</p> <p>3.....Metal & 90mm</p> <p>4.....Explosion Proof</p> <p>5.....Sanitary</p> <p>9.....Custom (Contact OTEK)</p> <p><u>CONTROL OUTPUTS (1,2)</u></p> <p>0.....None</p> <p>1.....Relays (4 ea.)</p> <p>2.....Non-Isol. Open Collector Xtrs. (4 ea.)</p> <p>3.....Isolated Retransmission (4-20mA)</p> <p>4.....Isolated 30VDC for Transmitter</p> <p>5.....Isolated Relays & 4-20mA Out</p> <p>6.....Isolated O.C.T. & 4-20mA</p> <p>7.....Isolated Relays & 30VDC Out</p> <p>8.....Isolated O.C.T. & 30VDC Out</p> <p>9.....Custom (Contact OTEK)</p> <p><u>SERIAL I/O (1,2,3,12)</u></p> <p>0.....None</p> <p>1.....Non-Isolated Parasitic RS232E</p> <p>2.....Non-Isolated RS232</p> <p>3.....Non-Isolated RS485</p> <p>4.....Non-Isolated USB</p> <p>9.....Custom (Contact OTEK)</p> <p><u>DISPLAY TYPE (7)</u></p> <p>0.....Bars Reflective</p> <p>1.....Bars Backlit (Tricolor)</p> <p>9.....Custom (Contact OTEK)</p>								

NOTES (Continued):

5. Contact **OTEK** for other grades and for M & N grades and available specs. Otek will build to certain nuclear or MIL-standards but testing and confirmation of compliance, if required, will need to be done by a third party and at customer's expense.
6. See data sheet description for more information on various options. For F.S. Input Signal (digit 2) ranges not listed, use option 9 and specify.
7. Standard display configuration: 0-10%=red, 10-20%=amber, 20-80%=green, 80-90%=amber, 90-100%=red. Field configurable only with serial communication.
8. Maximum power consumption (all options): 2 Watts
9. Specify sensor manufacturer and type for pH and % RH.
10. Zero and Span adjustments are behind the unit.
11. USB powered is limited to 0.5A @ 5V (V2.0). Contact OTEK for maximum loading.
12. Warning: AC signal power (Options Q-T) is not isolated from Serial I/O. Use an isolated P.T. or a serial isolator.

DOWNLOADS: For manuals, user-software or drivers: www.otekcorp.com