

# HI-QCPM SERIES

## COUNTER OWNERS MANUAL



**OTEK** Inc.  
4016 E. Tennessee St, Tucson, AZ USA 85714

# ORDERING GUIDE

**Hi-QCPM** ..... Hi-QCPM series counter/timer with screw terminal connectors.

**Display Color**

- 5 ..... Green LED
- 6 ..... Red LED
- 7 ..... Extended capabilities, custom curves, Green LED
- 8 ..... Extended capabilities, custom curves, Red LED

**Power**

- 0 ..... 85 to 264Vac, 90 to 370Vdc
- 1 ..... 9 to 32 Vdc, 8 to 28 Vac

**Setpoint Output**

- 0 ..... None
- 1 ..... Dual 10 A relays
- 2 ..... Opto isolated solid state relays

**Analog Output**

- 0 ..... None
- 1 ..... 0 to 20 mA, 0 to 10 Vdc
- 2 ..... Batch relay(for FR batch mode only)

**Digital Interface**

- 0 ..... None
- 1 ..... RS-232
- 2 ..... RS-485

**Input Type**

Select one of the following input option boards:

**Dual Channel Pulse or AC**

**Basic:** Frequency, rate, period, total, time interval

**Extended:** Basic plus rate and total, ratio, phase angle. stopwatch, arithmetic func-

tions, batching, linearize curves  
 Channel A: Dc to 1MHz, Channel B: Dc to 250kHz, 20mV to 250V, NPN, PNP, contact closure, logic level inputs, selectable debounce and frequency response

**FR** ..... Scalable to 999,999

**Analog Input**

**Basic:** rate, square root, flow

**Extended:** basic plus rate and total, square root, batching, linearize curves

Voltage to Frequency converter, single channel, displays to +/-999,999

**VF1** ..... 4 to 20mA

**VF2** ..... 0 to 1 mA

**VF3** ..... 0 to 10V

**Quadrature**

**Basic:** position,length, angle

**Extended:** basic function or rate

Count input x1, 2, or 4, anti-jitter circuitry, z channel zeroing, inputs are differential line receivers or logic levels.

**QD** ..... Position,length

**Remote Display**

6-digit display plus minus sign. Accepts RS-232 or RS-485 from computer, PLC, or other Laurel meters and displays transmitted value. Displayed value may be retransmitted as 0 to 10V or 4 to 20mA via the analog output and setpoints may be added to provide alarms from displayed value or alarm data via the serial interface. Requires RS485 or rs232 interface.

**No letters after model #** ..... +/-99999

# TABLE OF CONTENTS

1.	INTRODUCTION.....	PAGE 2
2.	RECEIVING AND UNPACKING .....	PAGE 3
3.	SAFETY CONSIDERATIONS .....	PAGE 3
4.	CONNECTOR WIRING INFORMATION .....	PAGE 4
5.	MECHANICAL ASSEMBLY .....	PAGE 6
6.	PANEL MOUNTING .....	PAGE 7
7.	CONNECTORS .....	PAGE 7
8.	OPERATING THE METER .....	PAGE 8
9.	SETTING MENU LOCKOUTS .....	PAGE 9
10.	SETUP MENU .....	PAGE 10
11.	DUAL CHANNEL SIGNAL CONDITIONER.....	PAGE 23
	11.1 SETTING JUMPERS FOR INPUT SIGNAL LEVELS .....	PAGE 23
	11.2 COMMON JUMPER SETTINGS .....	PAGE 23
	11.3 MODES OF OPERATION .....	PAGE 24
	11.4 RATE .....	PAGE 24
	11.5 PERIOD .....	PAGE 26
	11.6 TOTAL .....	PAGE 26
	11.7 TIME INTERVAL .....	PAGE 28
	11.8 STOPWATCH .....	PAGE 28
	11.9 PHASE ANGLE .....	PAGE 28
12.	V-TO-F SIGNAL CONDITIONER.....	PAGE 29
	12.1 SETTING JUMPERS FOR INPUT SIGNAL LEVELS .....	PAGE 29
	12.2 RATE .....	PAGE 29
	12.3 BATCH.....	PAGE 29
	12.4 RATE AND TOTAL .....	PAGE 30
	12.5 1/RATE .....	PAGE 30
13.	QUADRATURE SIGNAL CONDITIONER .....	PAGE 31
	13.1 SETTING JUMPERS FOR INPUT SIGNAL LEVELS .....	PAGE 31
	13.2 QUADRATURE DECODING .....	PAGE 32
	13.3 ZERO INDEX SETUP .....	PAGE 33
	13.4 MECHANICAL ZERO .....	PAGE 35
	13.5 SETUP SUMMARY .....	PAGE 36
	13.6 MANUFACTURERS OF OPTICAL ENCODERS .....	PAGE 37
	13.7 QUADRATURE RATE .....	PAGE 39
14.	DUAL ALARM OUTPUTS .....	PAGE 40
15.	RS-232 AND RS-485 INTERFACE .....	PAGE 41
16.	ANALOG OUTPUT .....	PAGE 43
17.	PARALLEL BCD OUTPUT .....	PAGE 44
18.	5, 10, AND 24VDC EXCITATION OUTPUTS .....	PAGE 45
19.	DIGITAL INPUTS .....	PAGE 46
20.	CALIBRATION .....	PAGE 47
21.	SPECIFICATIONS .....	PAGE 47
22.	GLOSSARY OF TERMS .....	PAGE 50

1.

## INTRODUCTION

The series of panel instruments is a versatile, cost effective solution to a wide variety of monitoring and control applications. These instruments are easily set to produce an accurate display of frequency, rate, total, period, time interval, phase, position, flow, etc. Front panel pushbutton or RS-232/RS-485 setup allows the user to customize the unit for a specific application. Digital scaling of zero and span provides direct readout in engineering units. A high stability crystal and digital calibration of all ranges eliminates drift associated with potentiometers found in non-microcomputer-based meters. The meter measures the period of the input signal to calculate frequency or rate. This fast read rate provides an accurate display of peak signal input and quick response in control applications. Selectable gate time (10ms to 99s) and adaptive filter ensure stable displayed readings and outputs while responding rapidly to changes of the input signal. Selective security lockout of the front panel setup protects against accidental changes to the meter configuration and simplifies use by the operator. The series uses a lightweight, high-efficiency switching power supply that operates from either AC or DC voltages and complies with safety regulations. The meter can be powered worldwide without changes to the supply. An optional low voltage supply operates on 9 to 37 Vdc from batteries or 8 to 28 Vac from sources such as 400 Hz aircraft power. Both supplies have isolated 5, 10, and 24Vdc excitation outputs to power transducers. The NEMA 4 (IP65) 1/8 DIN case is made of high impact, 94V-0 UL-rated plastic. Mounting is from the front of the panel and requires less than 110 mm behind the panel. All wiring is by removable plugs conforming to IEC950 safety standards. All output options are isolated from meter and power ground by 250 Vac minimum.

The dual setpoints have two form C ( 10 A @ 250 Vac ) relays or open collector outputs for alarm and control capabilities. Either setpoint may be latching or nonlatching and may be separately configured to be energized above or below the setpoint or in a fail-safe mode. Outputs may also be selected to operate from the filtered signal to reduce relay chatter or from the unfiltered signal for fast response. Snubber circuits and programmable relay switching time delay extend relay contact life.

Isolation of the 4 to 20 mA and 0 to +10 V analog outputs eliminates ground loop problems. The output may be scaled by front panel pushbuttons or RS-232/RS-485. For square root and custom curves, the output is linearized. Depending on the application, the analog output may be selected to operate from the filtered or unfiltered signal input. The 4 to 20 mA output will drive up to an 800 Ohm load with 16 V compliance

The meter offers RS-232 or RS-485 bidirectional communications or parallel, 3-state BCD output to interface with computers, PLC's or other digital devices. IBM PC compatible software is available for programming of the unit by the RS-232 and RS-485 interfaces.

2.

## RECEIVING AND UNPACKING

Your meter was carefully tested and inspected prior to shipment. Should the meter be damaged in shipment, notify the freight carrier immediately. In the event the meter is not configured as ordered or the unit is inoperable, return the unit to the place of purchase for repair or replacement. Please include a detailed description of the problem.

3.

## SAFETY CONSIDERATIONS

**Warning** : The use of this equipment in a manner other than specified may impair the protection of the device and subject the user to a hazard.

Visually inspect the unit for signs of damage. If the unit is damaged, do not attempt to operate.

This unit must be powered with AC ( mains ) from 85 to 264 Vac (90 to 370 Vdc) with the high voltage power supply option or 8 to 28 Vac (9 to 37 Vdc) with the low voltage power supply option. Verify that the proper power option is installed for the power to be used.

This meter has no AC ( mains ) switch; it will be in operation as soon as power is connected.

**Caution:** The 85 to 264 Vac (90 to 370 Vdc) mains connector (J1 Pins 1-3) is color coded Light Blue to differentiate it from other input and output connectors. The 8 to 28 Vac (9 to 37 Vdc) mains connector is not color coded because these voltages are not considered hazardous.

Do not make signal wiring changes or connections when power is applied to the instrument. Make signal connections before power is applied and, if reconnection is required, disconnect the AC ( mains ) power before such wiring is attempted.

To prevent electrical or fire hazard, do not expose the instrument to excessive moisture.

Do not operate the instrument in the presence of flammable gases or fumes; such an environment constitutes a definite safety hazard. This meter is designed to be mounted in a metal panel.

Verify the panel cutout dimensions and mount according to instructions.

## 4.

# CONNECTOR WIRING INFORMATION

### 4.1 CONNECTOR LOCATION

The connectors are the screw terminals that plug into the mating jack mounted on the printed circuit board. P3 is either a 6 conductor phone plug for RS-232 and RS-485 or a 30 pin, mass termination, edge connector for parallel BCD.

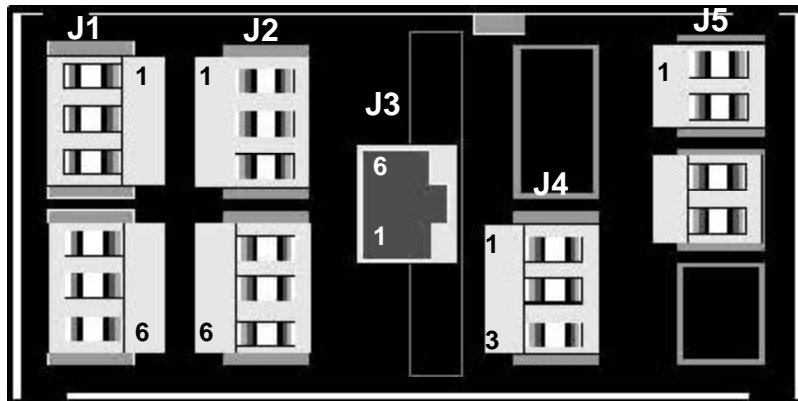

### 4.2 J1 - POWER AND DIGITAL CONTROLS

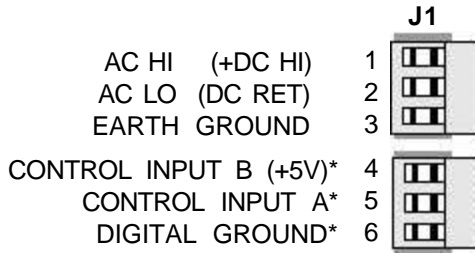

\*Note: Non-isolated external control inputs A and B are menu selectable.

### 4.3 J5 - SIGNAL INPUT

#### VOLTAGE-TO-FREQUENCY CONVERTER

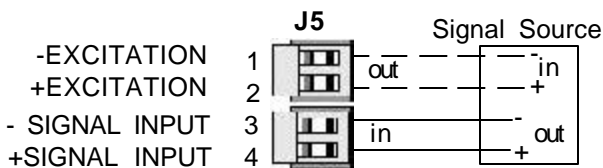

#### QUADRATURE INPUT (DIFFERENTIAL)

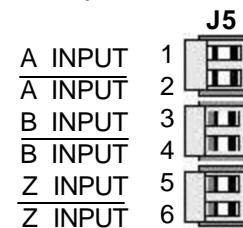

#### DUAL CHANNEL PULSE INPUT

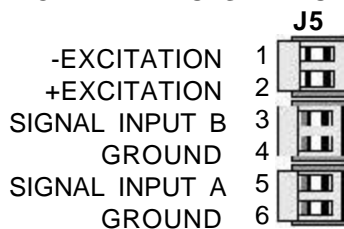

#### QUADRATURE INPUT (SINGLE-ENDED)

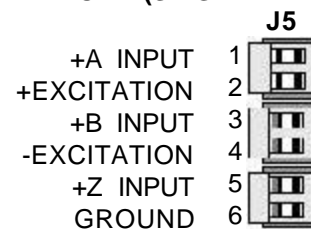

## 4.4 J2 - DUAL SETPOINT CONTROLLER

### RELAY OUTPUTS

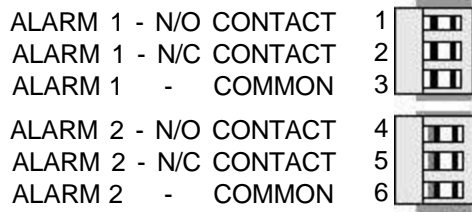

### SOLID STATE RELAY OUTPUTS

Switching AC 125Vac @120 ma max.

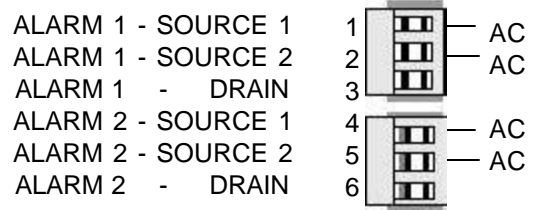

### SOLID STATE RELAY OUTPUTS Switching DC 125Vdc @240 ma max.

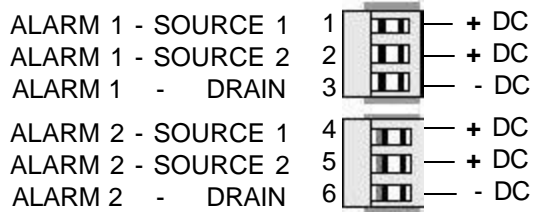

### \* SOLID STATE RELAY OUTPUTS

Switching DC 125Vdc @120 ma max.

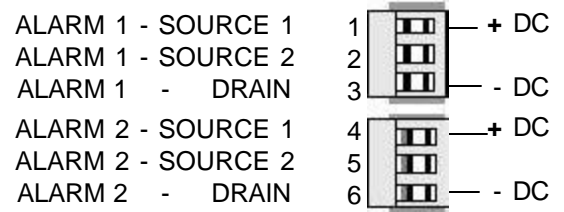

\* This configuration is directly compatible with the optotransistor output board.

## 4.5 J3 DIGITAL INTERFACE

### RS - 232 INTERFACE

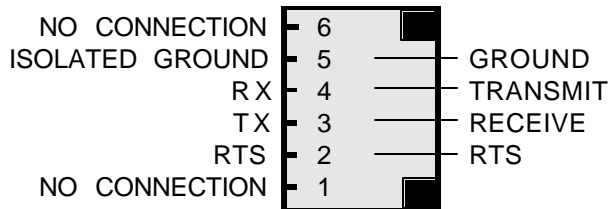

### RS - 485 INTERFACE

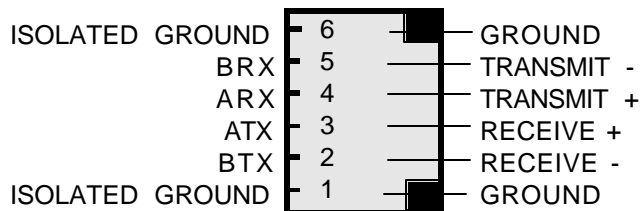

### BCD OUTPUT

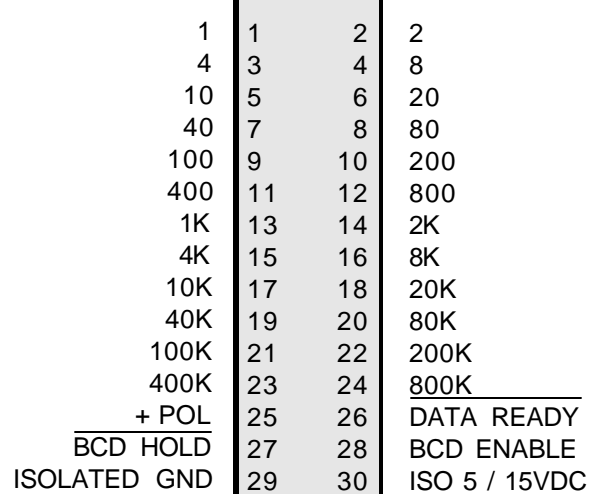

## 4.6 J4 - ANALOG OUTPUT

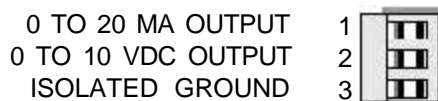

## 5.

# MECHANICAL ASSEMBLY

### 5.1 REMOVING THE REAR PANEL

To remove the rear panel, first remove any connectors that are installed. Press down on both rear panel retaining tab releases (see Fig. 5.1) and pull the top of the rear panel away from the case. The bottom of the rear panel will now lift out.

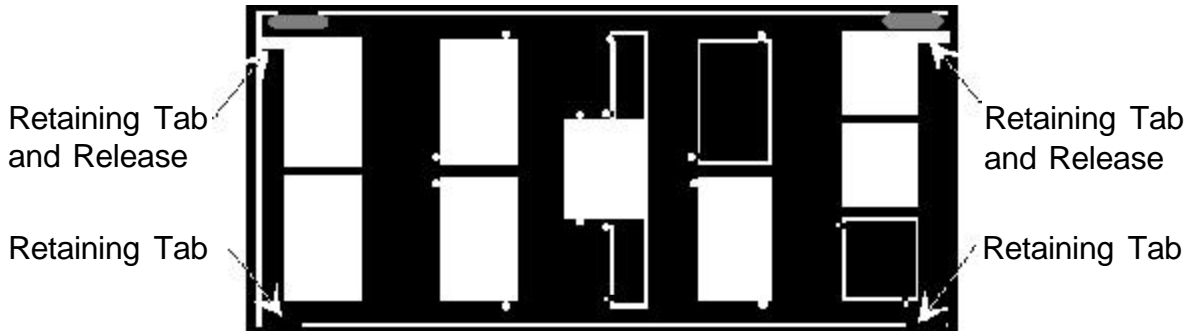
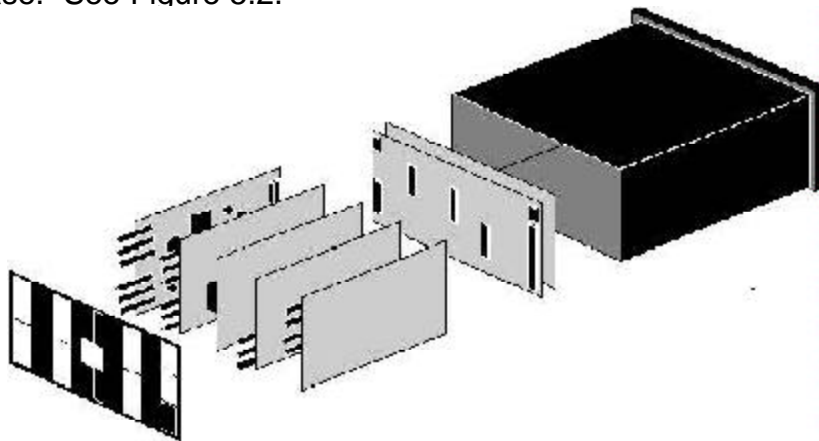

Figure 5.1

### 5.2 REMOVING THE METER FROM THE CASE

After removing the rear panel, the meter can be taken out of the case by carefully grasping the power supply board and signal conditioner board at the connectors and sliding the unit out the back of the case. See Figure 5.2.



### 5.3 REASSEMBLING THE METER

Reverse the preceding procedures to reinstall the meter in the case. After the meter is in the case, insert the bottom tabs on the rear panel into the case first. Care must be taken to ensure the printed circuit boards are properly aligned by the board retaining pins on the inside of the rear panel.



6.

## PANEL MOUNTING

Ensure the O-ring is in place. Turn the two mounting screws counterclockwise until the space between the mounting pawl and the bezel is greater than the panel thickness. Insert the meter in the panel cutout. Turn the mounting screws clockwise until the meter is securely mounted in the panel. Do not overtighten the mounting screws.

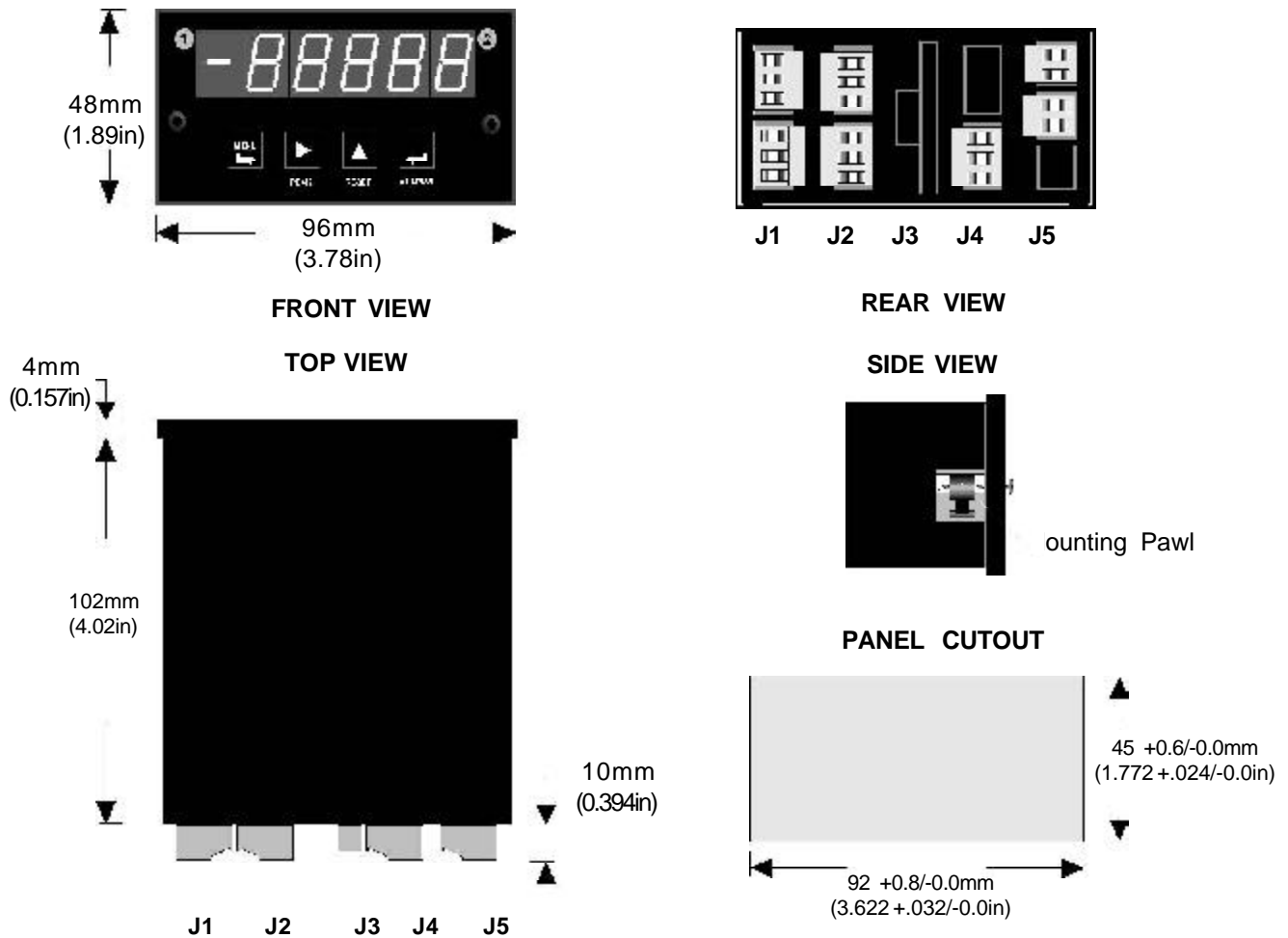

7.

## CONNECTORS

The meter uses UL/VDE rated screw terminal connections that plug into the mating PC jack.

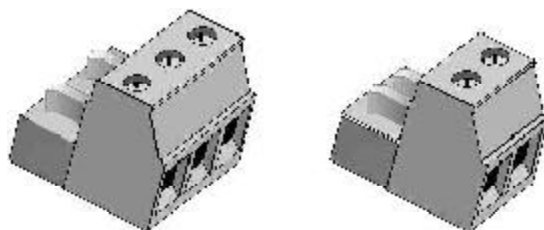

8.

## OPERATING THE METER

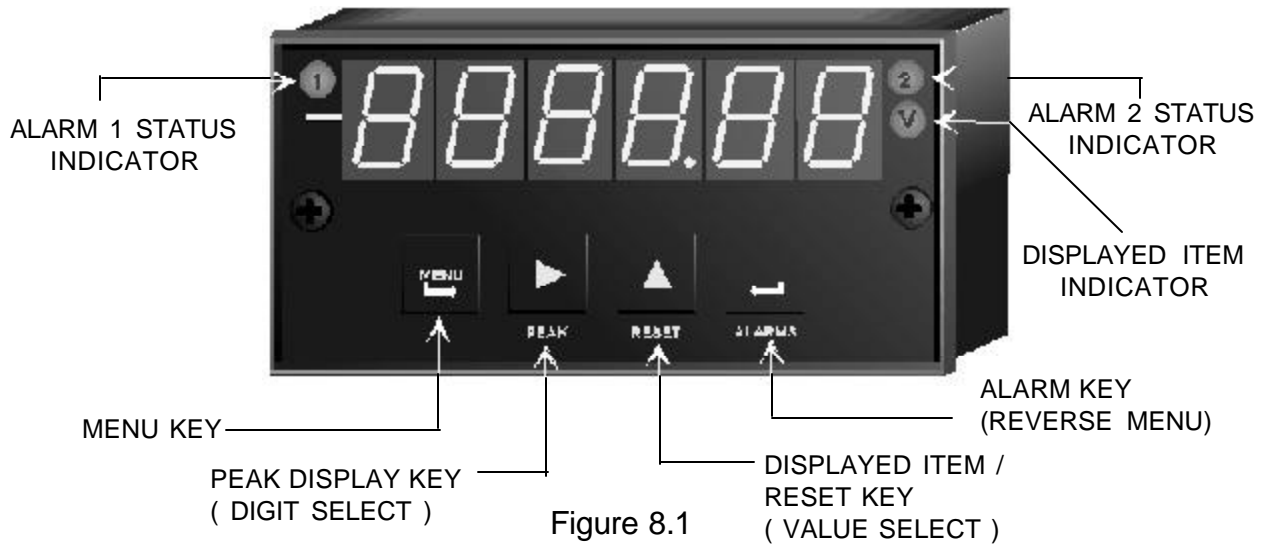

Figure 8.1

### OPERATING MODE

The meter is in normal operation and the input signal value is displayed.

### MENU MODE

The meter display and outputs do not respond to the input signal and alarm relays are deenergized.

### MENU KEY

The menu key changes the meter from the operating mode to the menu mode and steps through the various meter parameters that may be selected. These menu items may be “locked out” from front panel selection by software and hardware.

### PEAK DISPLAY KEY (DIGIT SELECT)

In the **Operating Mode**, pressing the Peak Display Key causes the peak value of the input signal to be displayed. Pressing the key again returns the display to the present value. In the **Menu Mode**, the Digit Select Key (Peak Display Key) is used to select input type and decimal point or to select one of the five display digits for programming. In the main menu, pressing the Digit Select Key causes the value or code that is stored for that menu item to be displayed and the left hand digit flashes. Each time the key is pressed, the next digit to the right will flash. The value of the flashing digit may be changed using the Value Select Key. In the **Alarm Mode**, pressing the Digit Select Key causes the most significant digit of the displayed setpoint value to flash. Digits are then selected the same as in the Menu Mode.

### RESET KEY (VALUE SELECT)

In the **Operating Mode**, holding the Reset Key depressed and pressing any other key causes a reset to occur. The Menu Key resets all meter functions, the Alarm Key resets any alarm conditions and the Peak Display Key resets the peak value to present value. If the Displayed Item Key (Reset Key) is pushed and released without depressing another button (and if the

meter is configured to display more than 1 item), display item #2 is displayed and the displayed item indicator lights. Repeating this selects display item #3 and displayed item indicator flashes. In the **Menu Mode** or **Alarm Mode**, the Value Select Key ( Reset Key) sets the value of the flashing digit. Each time the key is pressed, the value increases by one. Holding the key down causes the digit to automatically step through the numbers.

### ALARM KEY (REVERSE MENU)

In the Operating Mode, pressing the Alarm Key displays the setpoint of Alarm 1 and then Alarm 2. These values may be changed using the Digit Select Key and the Value Select Key. In the Menu Mode, pressing the Alarm Key steps the display backward through the menu.

## 9.

### SETTING MENU LOCKOUTS

For security and ease of operation, any or all program menu items may be disabled. Each function to be disabled is set to "1" in the menu items, "Loc 1", "Loc 2", "Loc 3" or "Loc 4". These lockout menu items may in turn be "locked-out" by installing an internal hardware shorting jumper. With the jumper installed, the operator has access only to enabled menu items.

#### 9.1 SETTING HARDWARE LOCKOUT JUMPER

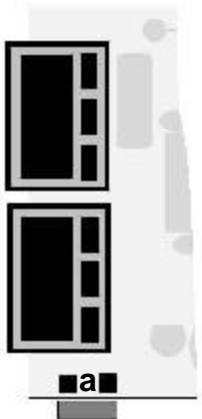

Power Supply Board  
Figure 9.1

#### Lockout Jumper

To access the jumper, remove the rear panel per Section 5.1. Remove jumper "a" located on the lower portion of the power supply board next to the input connectors (see figure at left) to allow access to the software lockout menu. Replace the jumper to remove access to lockout menu items.

**Jumper Removed** - Loc 1,2, 3 and 4 are displayed as menu items and allow other menu items to be locked out or enabled.

**Jumper Installed** - Loc 1,2, 3 and 4 are not displayed on program menu

**SETUP MENU**

**MENU KEY**

**DIGIT SELECT KEY**

**VALUE SELECT KEY**

DUAL CHANNEL SIGNAL CONDITIONER

<p><b>InPut</b> Input signal type</p>	<p><b>rAtE</b> Frequency or rate</p> <p>Note: (I1), (I2), and (I3) are display items 1, 2, and 3. The value that is displayed may be selected via front panel pushbutton.</p> <p><b>Basic counter:</b> A b, A Only</p> <p><b>Extended counter:</b> All items shown</p>	<p><b>A b</b> calculates rates for inputs A (I1) &amp; B (I2)</p> <p><b>A Only</b> calculates rate for input A (I1)</p> <p><b>bAtCH</b> calculates rate (I3), total (I1), grand total for batching (I2), input A</p> <p><b>A Atot</b> calculates rate (I1) and total for input A (I2)</p> <p><b>A btot</b> calculates rate for input A (I1) and total for input B (I2)</p> <p><b>A + b</b> calculates rate for input A (I2), rate for input B (I3), and sum of both inputs (I1)</p> <p><b>A - b</b> calculates rate for input A (I2), rate for input B (I3), and difference of both inputs (I1)</p> <p><b>A . b</b> calculates rate for input A (I2), rate for input B (I3), and product of both inputs (I1)</p> <p><b>A / b</b> calculates rate for input A (I2), rate for input B (I3), and ratio of both inputs (I1)</p> <p><b>A/b-1</b> calculates rate for input A (I2), rate for input B (I3), and draw of both inputs (I1)</p>
	<p><b>PEriod</b> Period</p> <p><b>Basic counter:</b> A b, A Only</p> <p><b>Extended counter:</b> All items shown</p>	<p><b>A b</b> calculates period for inputs A (I1) &amp; B (I2)</p> <p><b>A Only</b> calculates period for input A (I1)</p>

MENU KEY 

DIGIT SELECT KEY 

VALUE SELECT KEY 

DUAL CHANNEL SIGNAL CONDITIONER (CONT'D)

<p><b>InPut</b> Input signal type (cont"d)</p>	<p><b>PEriod</b> Period (cont'd)</p> <p>Note: (I1), (I2), and (I3) are display items 1, 2, and 3. The value that is displayed may be selected via front panel pushbutton.</p> <p><b>Basic counter:</b> A b, A Only</p> <p><b>Extended counter:</b> All items shown</p>	<p><b>A + b</b> calculates period for input A (I2), period for input B (I3), and sum of both inputs (I1)</p> <p><b>A - b</b> calculates period for input A (I2), period for input B (I3), and difference of both inputs (I1)</p> <p><b>A . b</b> calculates period for input A (I2), period for input B (I3), and product of both inputs (I1)</p> <p><b>A / b</b> calculates period for input A (I2), period for input B (I3), and ratio of both inputs (I1)</p>
	<p><b>totAL</b> Total</p> <p>Note: To count down, use negative scale factor.</p> <p><b>Basic counter:</b> A b, A Only</p> <p><b>Extended counter:</b> All items shown</p>	<p><b>A b</b> calculates totals for inputs A (I1) &amp; B (I2)</p> <p><b>A OnLy</b> calculates totals for input A (I1)</p> <p><b>A-BUpDn</b> calculates difference (I1) between A total and B total</p> <p><b>burst</b> calculates total # of bursts (I1) and burst frequency (I2), input A</p> <p><b>b Arat</b> calculates total for input b (I1) and rate for input A(I2)</p> <p><b>A bUPd</b> calculates total for input A (I1) with input B up/down control</p> <p><b>A binH</b> calculates total for input A (I1) with input B as count inhibit control</p> <p><b>A + b</b> calculates total for input A (I2), total for input B (I3), and sum of both inputs (I1)</p>

MENU KEY 

DIGIT SELECT KEY 

VALUE SELECT KEY 

DUAL CHANNEL SIGNAL CONDITIONER

<p><b>InPut</b> Input signal type (cont'd)</p>	<p><b>totAL</b> Total (cont'd)</p> <p>Note: Use A-B for up/down counting where input A is the up counts and input B is the down counts.</p> <p><b>Basic counter:</b> A b, A Only</p> <p><b>Extended counter:</b> All items shown</p>	<p><b>A - b</b> calculates total for input A (I2), total for input B (I3), and difference of both inputs (I1)</p> <p><b>A . b</b> calculates total for input A (I2), total for input B (I3), and product of both inputs (I1)</p> <p><b>A / b</b> calculates total for input A (I2), total for input B (I3), and ratio of both inputs (I1)</p>
	<p><b>ti Int</b> Time interval</p>	<p><b>A to b</b> calculates time from input A (leading or trailing edge of signal) to input B (leading or trailing edge of signal) . Display in mS or clock format (I1).</p>
	<p><b>StoP t</b> Stopwatch <b>Extended counter only</b></p>	<p><b>A to A</b> calculates time from input A leading edge to leading edge or trailing edge to trailing edge.</p> <p><b>A to b</b> calculates time from input A (leading or trailing edge of signal) to input B (leading or trailing edge) .</p>
	<p><b>PHASE</b> Phase angle <b>Extended counter only</b></p>	<p><b>A to b</b> calculates phase angle of input A to input B</p>

QUADRATURE INPUT

<p><b>InPut</b> Input signal type</p>	<p><b>quAdr</b> Input from quadrature encoder</p> <p><b>Basic counter:</b> total</p> <p><b>Extended counter:</b> total or rate</p>	<p><b>totAL</b> calculates total or position (I1)</p> <p><b>rAtE</b> calculates rate and direction (I1) or total (I1)</p>
-------------------------------------------	----------------------------------------------------------------------------------------------------------------------------------------	---------------------------------------------------------------------------------------------------------------------------

**MENU KEY** 

**DIGIT SELECT KEY** 

**VALUE SELECT KEY** 

**VOLTAGE-TO-FREQUENCY CONVERTER**

<p><b>InPut</b> Input signal type</p> <p>Note: (I1), (I2), and (I3) are display items 1, 2, and 3. The value that is displayed may be selected via front panel pushbutton.</p>	<p><b>UF4 20</b> 4 to 20ma signal input</p> <p><b>UF 0 1</b> 0 to 1ma signal input</p> <p><b>UF0 10</b> 0 to 10V signal input</p> <p><b>Basic counter:</b> A Only</p> <p><b>Extended counter:</b> All items shown</p>	<p><b>A OnLy</b> calculates rate for input A (I1)</p> <p><b>bAtCH</b> calculates rate (I3), total (I1), grand total for batching (I2), input A</p> <p><b>A Atot</b> calculates rate (I1) and total for input A (I2)</p> <p><b>Atot A</b> calculates rate for input A (I2) and total for input A (I1)</p> <p><b>1 / A</b> calculates the inverse of rate for input A (I1)</p>
----------------------------------------------------------------------------------------------------------------------------------------------------------------------------------------	-------------------------------------------------------------------------------------------------------------------------------------------------------------------------------------------------------------------------------------------	------------------------------------------------------------------------------------------------------------------------------------------------------------------------------------------------------------------------------------------------------------------------------------------------------------------------------------------------------------------------------

<p><b>SEtuP</b> Meter Setup</p>	<p><b>00000</b> Display total at power on</p>	<p><b>0</b> Reset total <b>1</b> Display stored total</p>
	<p><b>00000</b> Display of leading zeros</p>	<p><b>0</b> Blank leading zeros <b>1</b> Display leading zeros</p>
	<p><b>00000</b> Method of scaling (Scale1)</p>	<p><b>0</b> Scale1 using scale and offset <b>1</b> Scale1 using coordinates of 2 points</p>
	<p><b>00000</b> Method of scaling (Scale2)</p>	<p><b>0</b> Scale2 using scale and offset <b>1</b> Scale2 using coordinates of 2 points</p>
	<p><b>00000</b> Rear connector inputs A &amp; B</p> <p>Low input = true</p>	<p><b>0</b> A: Meter reset B: Function reset</p> <p><b>1</b> A: Meter reset B: Hold</p> <p><b>2</b> A: Meter reset B: Peak display</p> <p><b>3</b> A: Meter reset B: External gate</p> <p><b>4</b> A: Funct. reset B: Hold</p> <p><b>5</b> A: Function reset B: Peak display</p> <p><b>6</b> A: Funct reset B: Ext gate</p> <p><b>7</b> A: Hold B: Peak display</p>



MENU KEY 

DIGIT SELECT KEY 

VALUE SELECT KEY 

<p><b>SEtuP</b> Meter Setup (cont'd)</p>	<p><b>00000</b> Connector inputs (cont'd)  Low input = true</p>	<p><b>8</b> A: Hold B: Ext. gate  <b>9</b> A: Peak display  B: External gate  <b>A</b> A: Meter reset  B: Display blank  <b>b</b> A: Function reset  B: Display blank  <b>C</b> A: Hold B: Display blank  <b>d</b> A: Display blank  B: External gate  <b>E</b> A: Peak B: Display blank  <b>F</b> A: Display item 2  B: Display item 3</p>
<p><b>ConFIG</b> Meter configuration</p>	<p><b>0000</b> Display type</p>	<p><b>0</b> Normal, exponential overload  <b>1</b> Normal, 99999 overload  <b>2</b> 1 right dummy zero  <b>3</b> 2 right dummy zeros  <b>4</b> Clock (hr, min, or sec)  <b>5</b> Clock time (hh:mm:ss)  <b>6</b> Remote display (K command)  <b>7</b> Remote display (single value)  <b>Slave Remote Display</b>  <b>8</b> 1st value in string  <b>9</b> 2nd value in string  <b>A</b> 3rd value in string  <b>b</b> 4th value in string</p>
<p><b>0000</b> Meter type (Selectable only if extended meter)</p>	<p><b>0</b> Basic  <b>1</b> Extended  <b>2</b> Custom curve #1  <b>3</b> Custom curve #2 (V-F)</p>	
<p><b>0000</b> Square root of input rate</p>	<p><b>0</b> Rate input  <b>1</b> Square root of rate</p>	
<p><b>0000</b> Negative samples for sample-time totals.</p>	<p><b>0</b> Neg samples excluded  <b>1</b> Neg. samples included</p>	



MENU KEY 	DIGIT SELECT KEY 	VALUE SELECT KEY 
<b>dSPYno</b> Item to be displayed at power on.	<b>1</b> Enter display item #	<b>1</b> Display item 1 <b>2</b> Display item 2 <b>3</b> Display item 3
<b>PULSES</b> Number of pulses per zero (Quadrature only)	<b>00000</b> <b>00000</b> <b>00000</b> <b>00000</b> <b>00000</b> Enter number of pulses	Select 0 through 9 for flashing digit.
<b>GAtE t</b> Gate time (If not Batch)	<b>199.99</b> Select value from .01 to 199.99 seconds	Select 0 through 9 for flashing digit.
<b>dSPY t</b> Relay output time ( Batch only )	<b>199.99</b> Select value from .01 to 199.99 seconds	Select 0 through 9 for flashing digit.
<b>ti Out</b> Time out to display "0" if no input (If not Batch)	<b>199.99</b> Select value from .01 to 199.99 seconds	Select 0 through 9 for flashing digit.
<b>bAtCH</b> Batch (batch mode only)	<b>00000</b> Batch total and grand totals stop at preset values or count all input pulses	<b>0</b> Batch preset, grand preset <b>1</b> Batch all, grand preset <b>2</b> Batch preset, grand all <b>3</b> Batch all, grand all
	<b>00000</b> Reset and count direction	<b>0</b> Reset to 0 and count up <b>1</b> Set to offset1 & cnt down
	<b>00000</b> Reset at end of gatetime or with external signal	<b>0</b> Use gatetime to reset <b>1</b> Use External Function reset
	<b>0000</b> Grand total or batch #	<b>0</b> Item #2 = grand total <b>1</b> Item #2 =total # of batches
	<b>0000</b> Batch start	<b>0</b> Display "rEAdy" after reset <b>1</b> Start batch after reset
<b>FILtEr</b> Filtering	<b>00000</b> Filter type	<b>0</b> Adaptive filter <b>1</b> Conventional filter
	<b>00000</b> Display value	<b>0</b> Unfiltered display value <b>1</b> Filtered display value

MENU KEY 

DIGIT SELECT KEY 

VALUE SELECT KEY 

<b>FiLteR</b> Filtering (continued)	<b>00000</b> Peak value	<b>0</b> <b>1</b> Unfiltered peak value Filtered peak value
	<b>00000</b> Adaptive filter threshold	<b>0</b> <b>1</b> Low adaptive threshold High adaptive threshold
	<b>00000</b> Filter time constant	<b>0</b> <b>1</b> <b>2</b> <b>3</b> <b>4</b> <b>5</b> <b>6</b> <b>7</b> No filter 0.1 sec 0.2 sec 0.4 sec 0.8 sec 1.6 sec 3.2 sec 6.4 sec
<b>SLOPE</b> Trigger slope of input signal (if not V-to-F)	<b>00</b> Channel A input	Positive slope Negative slope
	<b>00</b> Channel B input	Positive slope Negative slope
<b>dEc.Pt1</b> Decimal point selection	<b>1.11111</b> <b>11.1111</b> <b>111.111</b> <b>1111.11</b> <b>11111.1</b> <b>111111.</b>	Use value select key to select decimal point
<b>dEc.Pt2</b> Decimal point selection	<b>2.22222</b> <b>22.2222</b> <b>222.222</b> <b>2222.22</b> <b>22222.2</b> <b>222222.</b>	Use value select key to select decimal point
<b>SCALE1</b> Scale factor and multiplier (Scale and Offset selected)	<b>0.00000</b> <b>0.00000</b> <b>0.00000</b> <b>0.00000</b> <b>0.00000</b> <b>0.00000</b> Scale factor <b>0.00001</b> to <b>100000</b> Multiplier	Select 0 through 9 for flashing digit. Decimal point fixed. Select scale factor multiplier
<b>OFFSt1</b> Offset or Zero Value	<b>0000.00</b> <b>0000.00</b> <b>0000.00</b> <b>0000.00</b> <b>0000.00</b> <b>0000.00</b>	Select 0 through 9 for flashing digit. Decimal point fixed by DecPt1.
<b>Lo in1</b> Low signal input value (Coordinates of 2 points selected)	<b>0.00000</b> <b>0.00000</b> <b>0.00000</b> <b>0.00000</b> <b>0.00000</b> <b>0.00000</b>	Select 0 through 9 for flashing digit. Decimal point fixed by input range on V-F
<b>Lo rd1</b> Low Displayed Reading at Low Signal Input	<b>0000.00</b> <b>0000.00</b> <b>0000.00</b> <b>0000.00</b> <b>0000.00</b> <b>0000.00</b>	Select 0 through 9 for flashing digit. Decimal point fixed by DecPt1.
<b>Hi in1</b> High signal input value	<b>0.00000</b> <b>0.00000</b> <b>0.00000</b> <b>0.00000</b> <b>0.00000</b> <b>0.00000</b>	Select 0 through 9 for flashing digit. Decimal point fixed by input range on V-F

**MENU KEY** 

**DIGIT SELECT KEY** 

**VALUE SELECT KEY** 

<p><b>Hi rd1</b> High displayed reading at high Signal Input</p>	<p><u>0000.00</u> <u>0000.00</u> <u>0000.00</u> <u>0000.00</u> <u>0000.00</u> <u>0000.00</u></p>	<p>Select 0 through 9 for flashing digit. Decimal point fixed by DecPt1.</p>
<p>(Scale and Offset selected) <b>SCALE2</b> Scale factor and multiplier</p>	<p><u>0.00000</u> <u>0.00000</u> <u>0.00000</u> <u>0.00000</u> <u>0.00000</u> <u>0.00000</u> Scale factor <u>0.00001</u> to <u>100000</u> Multiplier</p>	<p>Select 0 through 9 for flashing digit. Decimal point fixed. Select scale factor multiplier</p>
<p><b>OFFSt2</b> Offset or Zero Value</p>	<p><u>0000.00</u> <u>0000.00</u> <u>0000.00</u> <u>0000.00</u> <u>0000.00</u> <u>0000.00</u></p>	<p>Select 0 through 9 for flashing digit. Decimal point fixed by DecPt1.</p>
<p>(Coordinates of 2 points selected) <b>Lo in2</b> Low signal input value</p>	<p><u>0.00000</u> <u>0.00000</u> <u>0.00000</u> <u>0.00000</u> <u>0.00000</u> <u>0.00000</u></p>	<p>Select 0 through 9 for flashing digit.</p>
<p><b>Lo rd2</b> Low Displayed Reading at Low Signal Input</p>	<p><u>0000.00</u> <u>0000.00</u> <u>0000.00</u> <u>0000.00</u> <u>0000.00</u> <u>0000.00</u></p>	<p>Select 0 through 9 for flashing digit. Decimal point fixed by DecPt1.</p>
<p><b>Hi in2</b> High signal input value</p>	<p><u>0.00000</u> <u>0.00000</u> <u>0.00000</u> <u>0.00000</u> <u>0.00000</u> <u>0.00000</u></p>	<p>Select 0 through 9 for flashing digit.</p>
<p><b>Hi rd2</b> High displayed reading at high Signal Input</p>	<p><u>0000.00</u> <u>0000.00</u> <u>0000.00</u> <u>0000.00</u> <u>0000.00</u> <u>0000.00</u></p>	<p>Select 0 through 9 for flashing digit.</p>
<p><b>rd0 In</b> (V-to-F, square root and custom curve only) Corrects for zero errors</p>	<p><u>04.0000</u> Value set to actual voltage or current input at zero</p>	<p>Select 0 through 9 for flashing digit.</p>
<p><b>rESoLn</b> Resolution of arithmetic functions</p>	<p><u>0.00001</u> to <u>100000</u> Multiplier</p>	<p>Select multiplier</p>

**MENU KEY** 

**DIGIT SELECT KEY** 

**VALUE SELECT KEY** 

<p><b>Source</b> Source of alarm operation (only enabled if relay output installed)</p>	<p><b>00</b> Compare Alarm 1 to:</p>	<p><b>0</b> Filtered item <b>1</b> Item 1 <b>2</b> Item 2 <b>3</b> Item 3</p>
	<p><b>00</b> Compare Alarm 2 to:</p>	<p><b>0</b> Filtered item <b>1</b> Item 1 <b>2</b> Item 2 <b>3</b> Item 3</p>
<p><b>ALSEt</b> Alarm Operation Setup (only enabled if relay output installed)</p>	<p><b>00000</b> Relay output status when alarm active (On or off)</p>	<p><b>0</b> relay 1 on, relay2 on <b>1</b> relay 1 off, relay2 on <b>2</b> relay 1 on, relay2 off <b>3</b> relay 1 off, relay2 off</p>
	<p><b>00000</b> Relay output status when alarm active (Latching or nonlatching)</p>	<p><b>0</b> AL1 nonlatching AL2 nonlatching <b>1</b> AL1 latching AL2 nonlatching <b>2</b> AL1 nonlatching AL2 latching <b>3</b> AL1 latching AL2 latching</p>
	<p><b>00000</b> Alarm status  If deviation &gt; 0, then: active high = energizes outside deviation band active low = energizes inside deviation band</p>	<p><b>0</b> AL1 active high AL2 active high <b>1</b> AL1 active low AL2 active high <b>2</b> AL1 disabled AL2 active high <b>3</b> AL1 active high AL2 active low <b>4</b> AL1 active low AL2 active low <b>5</b> AL1 disabled AL2 active low <b>6</b> AL1 active high AL2 disabled <b>7</b> AL1 active low AL2 disabled <b>8</b> AL1 disabled AL2 disabled</p>

**MENU KEY** 

**DIGIT SELECT KEY** 

**VALUE SELECT KEY** 

<p><b>ALSEt</b> Alarm Operation Setup (cont'd)</p>	<p><b>00000</b> Select to operate as band deviation alarms or as hysteresis around the setpoint (if deviation set to &gt; 0)</p>	<p><b>0</b> AL1: Dev AL2: Dev  <b>1</b> AL1: Hys AL2: Dev  <b>2</b> AL1: Dev AL2: Hys  <b>3</b> AL1: Hys AL2: Hys  <b>4</b> No Hys or Dev in menu</p>
	<p><b>00000</b> Number of consecutive readings in the alarm zone to cause an alarm</p>	<p><b>0</b> After 1 reading  <b>1</b> After 2 readings  <b>2</b> After 4 readings  <b>3</b> After 8 readings  <b>4</b> After 16 readings  <b>5</b> After 32 readings  <b>6</b> After 64 readings  <b>7</b> After 128 readings</p>
<p><b>dEUtn1</b> Amount of deviation or hysteresis - Alarm 1  (only enabled if relay or open collector output installed)</p>	<p><b>000000</b> <b>000000</b> <b>000000</b>  <b>000000</b> <b>000000</b> <b>000000</b>            When deviation value is &gt; 0, alarms operate above and below setpoint by the value entered.</p>	<p>Select 0 through 9 for flashing digit.</p>
<p><b>dEUtn2</b> Amount of deviation or hysteresis - Alarm 2  (only enabled if relay or open collector output installed)</p>	<p><b>000000</b> <b>000000</b> <b>000000</b>  <b>000000</b> <b>000000</b> <b>000000</b>            When deviation value is &gt; 0, alarms operate above and below setpoint by the value entered.</p>	<p>Select 0 through 9 for flashing digit.</p>
<p><b>An Set</b> Setup of analog output  (only enabled if analog output installed)</p>	<p><b>00</b> Calibrated output is current or voltage</p>	<p><b>0</b> Current output  <b>1</b> Voltage output</p>
	<p><b>00</b> Analog output source</p>	<p><b>0</b> Filtered item  <b>1</b> Item #1  <b>2</b> Item #2  <b>3</b> Item #3</p>
<p><b>An Lo</b> Display value for 0 voltage or current output</p>	<p><b>0000.00</b> <b>0000.00</b> <b>0000.00</b>  <b>0000.00</b> <b>0000.00</b> <b>0000.00</b></p>	<p>Select 0 through 9 for flashing digit. Decimal point location fixed by dEC.Pt selection.</p>

**MENU KEY** 

**DIGIT SELECT KEY** 

**VALUE SELECT KEY** 

<p><b>An Hi</b> Display value for 10 volts or 20 ma output</p>	<p><u>0000.00</u> <u>0000.00</u> <u>0000.00</u> <u>0000.00</u> <u>0000.00</u> <u>0000.00</u></p>	<p>Select 0 through 9 for flashing digit. Decimal point location fixed by dEC.Pt selection.</p>
<p><b>Ser 1</b> Serial interface setup  (only enabled if communications board installed)</p>	<p><u>000</u> Output filtering</p>	<p><u>0</u> Send unfiltered signal <u>1</u> Send filtered signal</p>
	<p><u>000</u> Baud rate</p>	<p><u>0</u> 300 baud <u>1</u> 600 baud <u>2</u> 1200 baud <u>3</u> 2400 baud <u>4</u> 4800 baud <u>5</u> 9600 baud <u>6</u> 19200 baud</p>
	<p><u>000</u> Digital output rate rr = reading rate (rate dependent on gate time and input frequency)</p>	<p><u>0</u> Output at reading rate <u>1</u> Output at rr/2 <u>2</u> Output at rr/4 <u>3</u> Output at rr/8 <u>4</u> Output at rr/16 <u>5</u> Output at rr/32 <u>6</u> Output at rr/64 <u>7</u> Output at rr/128 <u>8</u> Output at rr/256</p>
<p><b>Ser 2</b> Serial interface setup  (only enabled if communications board installed)</p>	<p><u>0000</u> Line Feed</p>	<p><u>0</u> None after carriage rtn <u>1</u> LF after carriage return</p>
	<p><u>0000</u> Alarm data transmitted with meter readings</p>	<p><u>0</u> No alarm data <u>1</u> Alarm data with reading</p>
	<p><u>0000</u> Control of digital output</p>	<p><u>0</u> Continuous output <u>1</u> Output on RS-232 / RS-485 command only</p>
	<p><u>0000</u> Meter address for RS-232/RS-485 communication</p>	<p>Addresses 1 thru 15 are denoted by 1 thru 9 and A thru F. Addresses 16 thru 31 use the same character followed by a decimal point</p>

**MENU KEY** 

**DIGIT SELECT KEY** 

**VALUE SELECT KEY** 

<p><b>Ser 3</b> Serial interface setup</p> <p>(only enabled if communications board installed)</p>	<p><b>00000</b> RS485 full or half duplex</p>	<p><b>0</b> Full duplex <b>1</b> Half duplex</p>
	<p><b>00000</b> Meter recognition character</p>	<p><b>0</b> " * " character <b>1</b> Custom character</p>
	<p><b>00000</b> RS232 RTS type</p>	<p><b>0</b> Nonlatching RTS <b>1</b> Latching RTS</p>
	<p><b>00000</b> Carriage return (and LF, if selected)</p>	<p><b>0</b> Only at end of all items <b>1</b> At end of each item (If alarm, only at end)</p>
	<p><b>00000</b> Data sent via communications (if BCD, only 1 item allowed)</p>	<p><b>0</b> All active items sent <b>1</b> Item #1 only <b>2</b> Item #2 only (if active) <b>3</b> Item #3 only (if active) <b>4</b> Peak value <b>5</b> All active items + peak</p>
<p><b>CALib</b> Calibration</p>	<p><b>000000</b> Calibration of crystal in parts per million</p>	<p>Select 0 through 9 for flashing digit.</p>
<p><b>Loc 1</b> Lockout of Menu Items (Lockout jumper must be removed to access Loc 1, 2, 3, 4. See Figure 9.1)</p>	<p><b>0000</b> Input type selection</p>	<p><b>0</b> Enabled <b>1</b> Disabled</p>
	<p><b>0000</b> Meter setup and configuration</p>	<p><b>0</b> Enabled <b>1</b> Disabled</p>
	<p><b>0000</b> Pulses, gate time, time out, and batch setup</p>	<p><b>0</b> Enabled <b>1</b> Disabled</p>
	<p><b>0000</b> Filter set up</p>	<p><b>0</b> Enabled <b>1</b> Disabled</p>

**MENU KEY** 

**DIGIT SELECT KEY** 

**VALUE SELECT KEY** 

<p><b>Loc 2</b> Lockout of Menu Items (Lockout jumper must be removed to access Loc 1, 2, 3, 4. See Figure 9.1)</p>	<p><b>0000</b> Slope and decimal points</p>	<p><b>0</b> Enabled <b>1</b> Disabled</p>
	<p><b>0000</b> Scale and offset, coordinates of 2 points, resolution</p>	<p><b>0</b> Enabled <b>1</b> Disabled</p>
	<p><b>0000</b> Alarm setup and deviation</p>	<p><b>0</b> Enabled <b>1</b> Disabled</p>
	<p><b>0000</b> Allow alarm setpoint changes</p>	<p><b>0</b> Enabled (if view setpoints enabled) <b>1</b> Disabled</p>
<p><b>Loc 3</b> Lockout of Menu Items (Lockout jumper must be removed to access Loc 1, 2, 3, 4. See Figure 9.1)</p>	<p><b>0000</b> Analog out setup &amp; scaling</p>	<p><b>0</b> Enabled <b>1</b> Disabled</p>
	<p><b>0000</b> Serial communications setup</p>	<p><b>0</b> Enabled <b>1</b> Disabled</p>
	<p><b>0000</b> Calibration</p>	<p><b>0</b> Enabled <b>1</b> Disabled</p>
	<p><b>0000</b> Change displayed item</p>	<p><b>0</b> Enabled <b>1</b> Disabled</p>
<p><b>Loc 4</b> Lockout of Menu Items (Lockout jumper must be removed to access Loc 1, 2, 3, 4. See Figure 9.1)</p>	<p><b>0000</b> View peak display</p>	<p><b>0</b> Enabled <b>1</b> Disabled</p>
	<p><b>0000</b> View setpoints</p>	<p><b>0</b> Enabled <b>1</b> Disabled</p>
	<p><b>0000</b> Front panel auxiliary resets (Peak and latched alarm)</p>	<p><b>0</b> Enabled <b>1</b> Disabled</p>
	<p><b>0000</b> Front panel counter reset</p>	<p><b>0</b> Enabled <b>1</b> Disabled</p>



11.

**DUAL CHANNEL SIGNAL CONDITIONER**

**11.1 SETTING JUMPERS FOR INPUT SIGNAL LEVELS**

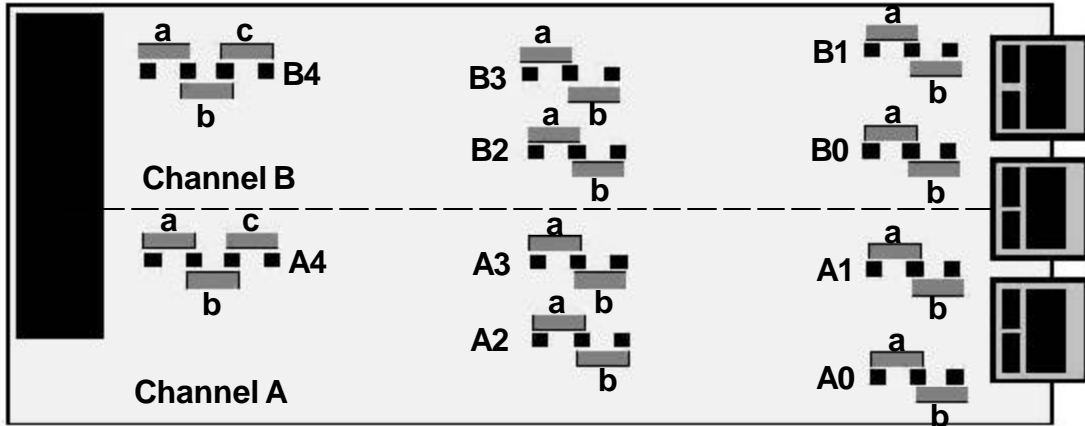

**Minimum High and Low Input Signal Levels**

The jumper settings for Channel A (A2 & A3) and Channel B (B2 & B3) are selected depending on the input amplitude. The input signal voltage must exceed the high and low threshold per the following table or the meter will not operate properly. The larger the difference between the high and low thresholds, the more immune the meter is to input signal noise.

A3	Low	High	A3	A2	Low	High	A3	A2	Low	High
B3	Threshold	Threshold	B3	B2	Threshold	Threshold	B3	B3	Threshold	Threshold
a	-12mV	+12mV	a	a	+30mV	+60mV	b	a	-30mV	-20mV
b	-150mV	+150mV	a	b	+350mV	+600mV	b	b	-600mV	-350mV
-	-1.15V	+1.15V	a	-	+1.25V	+2.1V	b	-	-2.1V	-1.25V

**Jumper Definition and Debounce Circuit**

Pullup or pulldown resistors are used with open collector devices and dry contact closures to provide input signal bias and should not be connected for other inputs. The debounce circuit keeps the meter from counting extra pulses due to contact bounce.

<b>A0 &amp; B0</b>	-	1MHz Input max	<b>A4 &amp; B4</b>	<b>Time Constant (Debounce)</b>
	a	30KHz Input max		
	b	250Hz max		
<b>A1 &amp; B1</b>	a	2Kohm input pullup +5V	a, c	3 mSec
<b>A1 &amp; B1</b>	b	2Kohm input pulldown -5V	c	50 mSec

**11.2 COMMON JUMPER SETTINGS**

Input type	Vmax	Channel A and B Jumpers				
		A0 & B0	A1 & B1	A2 & B2	A3 & B3	A4 & B4
Logic Levels	250	-	-	-	a	b
Open Collector						
Npn Transistor	NA	a	a	-	a	b
Pnp Transistor	NA	a	b	-	b	b
Contact closures	NA	a or b	a	-	a	a, c
Line Frequency	250	b	-	-	-	a, c
Turbine Flow	250	a	-	a	-	b

**Note:** All Channel A and Channel B settings may be different based on input signal type.

### 11.3 MODES OF OPERATION

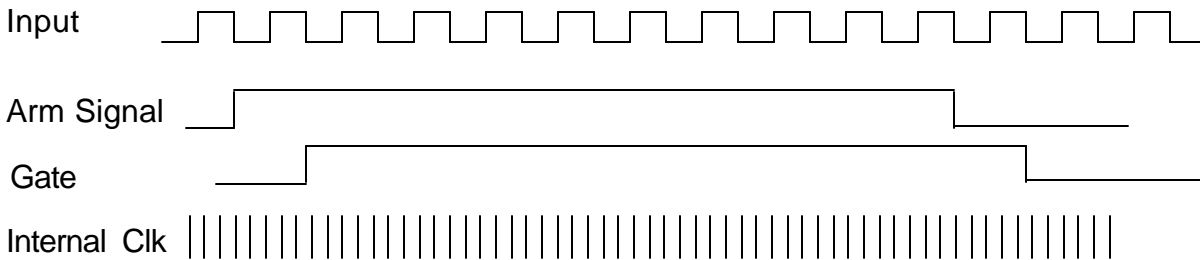

The measurement starts with an input signal transition in one direction and ends, after the expiration of the selected gate time, with the next input signal transition in the same direction such that the conversion time or period is measured over an integral number of input cycles. The internal Start signal ARMS the gate circuit so that the next input signal transition actually OPENS the gate. When the gate is detected to be open, the gate time begins. At the end of the gate time, the gate circuit is DISARMED, and the next input signal transition CLOSES the gate. When both inputs A & B are active with separate gates, such as measuring Rate on both channels, the gate time begins when both gates are detected to be open. The program calculations begin when both gates are detected to be closed.

### 11.4 RATE

**A ONLY, RATE A B** Either one or two channels of rate may be displayed. If one channel is displayed the input is on channel A and decimal point1, scale1 and offset1 apply to the input. If two channels are displayed decimal point1, scale1 and offset1 apply to channel A and decimal point2, scale2 and offset2 apply channel B. Either channel may be displayed by pressing and releasing the reset key . Gate time setting selects the update rate of meter. The longer the gate time, the more cycles of the input signal averaged. If the period of the input signal is longer than the gate time, only 1 period of the input is calculated and determines the conversion time. Time out is the length of time the meter waits for a signal to start a conversion or end a conversion. If pulses are not received before the time out ends, the meter reads zero. The longer the time out, the lower the minimum frequency the meter can display

**Frequency** displayed in Hz with scale factor of 1 and multiplier of 1. Increasing the multiplier increases resolution (.1 to .00001Hz). Decreasing the multiplier allows display in kHz or MHz.

**Rate** displayed in engineering units by scale factor and multiplier. Using coordinates of 2 points to scale meter, low input and high input are entered in Hz.

**BATCH** displays total of channel A as item 1, grand total or number of batches as item 2 and rate as item 3. Batch requires a Batch Relay board that plugs into the Analog Output Slot. It contains Relay #3 for use as the Batch Controller. This leaves Relay #1 and Relay #2 for use as either Pre-warn, End-of-process or Rate alarms. When Reset in the BATCH mode, the counter resets and then displays "rEAdy". It waits until the Reset button is pushed and then immediately energizes Relay #3 and starts displaying the Batch Total. When the preset value is reached, Relay #3 de-energizes for a period of time equal to the GATETIME setting. At the end of GATETIME, the Batch Total resets,

Relay #3 energizes and the cycle repeats.

As an option, the cycle can be reset from an external signal FUNCTION RESET. The GATETIME is not used and Relay #1 remains de-energized until the FUNCTION RESET external input is grounded for a minimum of 3.33 mS. Sometime during that period, the Batch Total is reset and Relay #1 is energized.

The Batch Total is displayed as Item #1 and may be configured to count up from 0 to the preset value, or to count down from the preset value to 0. The preset value is placed in OFFST1 and the Batch Total is the total input pulses with SCALE1 and DECPT1 applied. In the BATCH mode, SCALE1 is always set to a positive value whether counting up or counting down.

The Grand Total is kept as Item #2. SCALE1 and DECPT1 also apply to the Grand Total except the absolute value is used so that the Grand Total always increases from an initial value of zero when the counter is initially Reset. It is calculated as the sum of the previous Batch Totals + the current Batch Total. The Grand Total can overflow to the exponential format.

As an alternative, Item #2 can be configured to be the Number of Batches instead of the Grand Total. If it is, SCALE1 does not apply to it and the Decimal Point is always 1. Item #3 is the Rate calculated with a fixed 20 mS (or 1 cycle min) gatetime. SCALE2, OFFSET2 and DECPT2 apply to the Rate.

Relay #1 is activated by SETPT#1 and Relay #2 is activated by SETPT#2, and each may be configured for either

- Item#1 - Batch Total (Pre-warn),
- Item #2 - Grand Total or # Batches, or
- Item #3 - Rate.

It is possible to configure both for the same Item. An example would be two Pre-warns.

**RATE A , TOTAL A** displays total of channel A as item 2, and rate as item 1. Total is a sample time total determined the rate multiplied by the time between conversions. This input is used if square root or custom curve is selected. Decimal point2, scale2 and offset2 apply to total and is calculated from the displayed valued of rate and decimal point1, scale1 and offset1 apply to rate. Total may count down from an offset value by entering a negative scale factor. Use Rate A, Total B to display the rate and total of a single linear input by tying channel A and B inputs together.

**RATE A AND TOTAL B** displays total of channel B as item 2, and rate of channel A as item 1. Decimal point2, scale2 and offset2 apply to total and decimal point1, scale1 and offset1 apply to rate. Total may count down from an offset value by entering a negative scale factor. Rate and total of a single input may be displayed by tying channel A and B inputs together

**RATE A+B** is the same as Rate A, Rate B except that Rate A is displayed as item 2, Rate B is displayed as item 3 and the sum of A and B is displayed as item 1. Decimal point 1 applies to both A and B and decimal point 2 applies to the sum of A and B. The resolution of the sum is determined by setting the multiplier (Resolution) from .00001 to 100000.

**RATE A-B** is the same as Rate A+B except that B is subtracted from A

**RATE AxB** is the same as Rate A+B except that A is multiplied by B.

**RATE A/B (Ratio)** is the same as Rate A+B except that A is divided by B. Rate A and B may be scaled such that the ratio of A/B is 1. When the value of B increases the ratio is a number less than 1 and when it decreases the number is greater than 1.

**RATE A/B-1 (Draw)** is the same as Rate A/B (Ratio) except that 1 is subtracted from the ratio to give a zero value when the ratio of the 2 inputs is 1. This is used in applications where two rollers, etc. should be rotating at the same speed and displays the amount of tension between the two rollers.

## 11.5 PERIOD

**A ONLY, PERIOD A B** Period of either channel A input or both A and B may be displayed. If one channel is displayed the input is on channel A and decimal point1, scale1 and offset1 apply to the input. If two channels are displayed decimal point1, scale1 and offset1 apply to channel A and decimal point2, scale2 and offset2 apply channel B. Either channel may be displayed by pressing and releasing the reset key . The displayed period of the input signal is not affected by the gate time but the longer the gate time the more periods of the input signal that are averaged. The shorter the gate time, the faster the meter outputs and alarms are updated.

**PERIOD A+B** is the same as Period A, Period B except that Period A is displayed as item 2, Period B is displayed as item 3 and the sum of A and B is displayed as item 1. Decimal point 1 applies to both A and B and decimal point 2 applies to the sum of A and B. The resolution of the sum is determined by setting the multiplier (Resolution) from .00001 to 100000.

**PERIOD A-B** is the same as Period A+B except that B is subtracted from A

**PERIOD Ax/B** is the same as Period A+B except that A is multiplied by B.

**PERIOD A/B (Ratio)** is the same as Period A+B except that A is divided by B. Period A and B may be scaled such that the ratio of A/B is 1. When the value of B increases the ratio is a number less than 1 and when it decreases the number is greater than 1.

## 11.6 TOTAL

**A ONLY, TOTAL A B** Total of the number of pulses of either channel A or both A and B may be displayed. If one channel is displayed the input is on channel A and decimal point1, scale1 and offset1 apply to the input. If two channels are displayed decimal point1, scale1 and offset1 apply to channel A and decimal point2, scale2 and offset2 apply channel B. Either channel may be displayed by pressing and releasing the reset key or both channels may be reset using the external input "Function Reset". By setting an offset in the meter and a negative scale factor, the meter counts down from a preset value to zero.

**TOTAL A-B UPDN** is the same as Total A, Total B except that Total A is displayed as item 2, Total B is displayed as item 3 and the difference of A minus B is displayed as item 1. Decimal point 1 applies to both A and B and decimal point 2 applies to the sum of A and B. The resolution of the sum is determined by setting the multiplier (Resolution) from .00001 to 100000.

**BURST** measures the frequency of a burst of pulses from channel A as item 2, and total number of bursts as item 1. Decimal point2, scale2 and offset2 apply to total and decimal point1, scale1 and offset1 apply to rate. Gate time must be set greater than the minimum frequency of the burst frequency and less than the minimum time between bursts. Time out is set to the maximum value.

**TOTAL A AND RATE B** displays total of channel A as item 1, and rate of channel B as item 1. Decimal point2, scale2 and offset2 apply to total and decimal point1, scale1 and offset1 apply to rate. Total may count down from an offset value by entering a negative scale factor. Rate and total of a single input may be displayed by tying channel A and B inputs together.

**TOTAL A AND B UP/DOWN CONTROL** displays total of channel A as item 1. Decimal point1, scale1 and offset1 apply to total. Up/down counting is controlled by the input level of channel B. The maximum input frequency on A that can be counted is 250 kHz, or a minimum of 4 uS between pulses. If the menu item SLOPE is set to 0 for Channel B (Digit 6) then a low level on the B input causes Channel A to count Up and a high level on the B input causes Channel A to count Down. If the SLOPE of Channel B is set to 1, the opposite occurs.

**TOTAL A AND B INHIBIT** displays total of channel A as item 1. Decimal point1, scale1 and offset1 apply to total. The input signal to be counted is applied to Channel A and the Inhibit control signal to Channel B. The maximum input frequency that can be counted is 2 MHz or a minimum of 0.5 uS between pulses. If the menu item SLOPE is set to 0 for channel B (Digit 6) then a low level on the B input allows counting of the Channel A input signal and a high level on the B input inhibits counting. If the SLOPE of Channel B is set to 1, the opposite occurs.

**TOTAL A+B** is the same as Total A, Total B except that Total A is displayed as item 2, Total B is displayed as item 3 and the sum of A and B is displayed as item 1. Decimal point 1 applies to both A and B and decimal point 2 applies to the sum of A and B. The resolution of the sum is determined by setting the multiplier (Resolution) from .00001 to 100000.

**TOTAL A-B** is the same as Total A+B except that B is subtracted from A

**TOTAL AxB** is the same as Total A+B except that A is multiplied by B.

**TOTAL A/B (Ratio)** is the same as Total A+B except that A is divided by B. Total A and B may be scaled such that the ratio of A/B is 1. When the value of B increases the ratio

is a number less than 1 and when it decreases the number is greater than 1.

## 11.7 TIME INTERVAL

**TIME INTERVAL A TO B** measures time between an input on channel A and an input on channel B. Time measurement starts when a pulse is applied to channel A (positive edge if slope A is 0, negative edge if slope A is 1) and the measurement ends when a pulse is received on channel B (positive edge if slope B is 0, negative edge if slope B is 1). A single pulse may be measured by tying input A and B together and selecting a positive or negative edge to start (Slope A) and the opposite polarity edge to stop (Slope B). If a number of start and stop pulses occur during the gate time, the value displayed is the average of the pulse widths. The value is updated at the end of each gate.

## 11.8 STOPWATCH

**STOPWATCH A TO A** measures time between an start pulse on channel A and a second pulse on A to stop timing. Timing may be set to start and stop on either the positive or negative edges of the pulses (Slope A). The time (item #1) may be displayed in seconds, minutes or hours (with decimal point) using scale and multiplier with the clock time display (hr, min, or sec) selected. Clock time (fixed format) displays HH:MM:SS. Time is reset to 0 when a new start pulse occurs. Item #2 displays the accumulated total time of Item #1.

**STOPWATCH A TO B** measures time between an start pulse on channel A and a stop pulse on B. to stop timing. Timing is the same as A to A except in addition to separate start and stop pulses, by tying input A and B together, a single contact closure may start and stop timing by selecting the opposite Slope for A and B.

## 11.9 PHASE ANGLE

**PHASE ANGLE A TO B** measures the phase relationship between a signal on input A and input B. The displayed value is 0 to 360 degrees. Resolution is determined by Scale 1.

## 12.

# V - TO - F SIGNAL CONDITIONER

### 12.1 SETTING JUMPERS FOR INPUT SIGNAL LEVELS



Input Range	Jumper Position
0 to 10V	None
0 to 1mA	a
4 to 20mA	b

### 12.2 RATE

**Rate A** is the voltage or current input converted to a frequency output of 0 to 100kHz. The period of the frequency is measured and converted to a rate by  $1/\text{period}$  and applying Scale1 and Offset1. Scaling may also be set by using coordinates of 2 points where low and high input signals and the corresponding low and high displayed values are entered.

### 12.3 BATCH

**Batch** displays total of voltage or current input as item 1, grand total or number of batches as item 2 and rate as item 3. Relay #1 is used as the Batch Controller. This leaves Relay #2 for use as either Pre-warn, End-of-process or Rate alarm. When reset in the batch mode, the counter resets and then displays "rEAdy". It waits until the reset button is pushed and then immediately energizes Relay #1 and starts displaying the batch total. When the preset value is reached, Relay #1 de-energizes for a period of time equal to the Time out setting. At the end of time out, the Batch Total resets, Relay #1 energizes and the cycle repeats.

As an option, the cycle can be reset from an external signal Function Reset. The Time Out is not used and Relay #1 remains de-energized until the Function Reset external input is grounded for a minimum of 3.33 mS. Sometime during that period, the Batch Total is reset and Relay #1 is energized.

The Batch Total is displayed as Item #1 and may be configured to count up from 0 to

the preset value, or to count down from the preset value to 0. The preset value is placed in Setpoint 1 and the Batch Total is the total with Scale1 and decimal point1 applied. In the Batch mode, Scale1 is set to a positive value to count up and a negative value to count down. Offset1 is set to zero when counting up and to the preset value when counting down.

The Grand Total is kept as Item #2. Scale1 and decimal point1 also apply to the Grand Total except the absolute value is used so that the Grand Total always increases from an initial value of zero when the counter is initially Reset. It is calculated as the sum of the previous Batch Totals + the current Batch Total. The Grand Total can overflow to the exponential format.

As an alternative, Item #2 can be configured to be the Number of Batches instead of the Grand Total. If it is, Scale2 does not apply to it and the Decimal Point is always 1.

Item #3 is the Rate calculated with a selectable gatetime. Scale2, Offset2 and decimal point 2 apply to the Rate.

Relay #2 is activated by Setpoint#2, and may be configured for either

- Item#1 - Batch Total (Pre-warn),
- Item #2 - Grand Total or # Batches, or
- Item #3 - Rate.

## 12.4 RATE AND TOTAL

**Rate A, Total A** rate is calculated the same as **Rate A** above and displayed as Item1 and total is calculated based on the rate versus time between conversions. Scale2 and Offset2 are calculated from the displayed rate and apply to total. The rate may be displayed as units per second, per min, or per hour but the total is always incremented by the displayed value of the rate every second when the scale factor is set to 1. If the rate is per minute, the rate must be multiplied by 1/60, so that the total will equal the displayed rate at the end of 1 min. To totalize units per hour, the rate must be multiplied by 1/3600. The scale and multiplier for Scale 2 is set to 1.66667 and .01 for units per minute and 2.77778 and .0001 for units per hour. Total is displayed as Item 2.

**Total A, Rate A** same as above except total is displayed as Item1 and rate as Item2

## 12.5 1/RATE

**1/Rate A** is the voltage or current input converted to a frequency output of 0 to 100kHz. The period of the frequency is measured and converted to time by applying Scale1 and Offset1. Scaling may also be set by using coordinates of 2 points where low and high input signals and the corresponding low and high displayed values are entered. An example is converting speed to time and displaying the time an item takes to travel through an oven.



13.

**QUADRATURE SIGNAL CONDITIONER**

13.1 SETTING JUMPERS FOR INPUT SIGNAL LEVELS

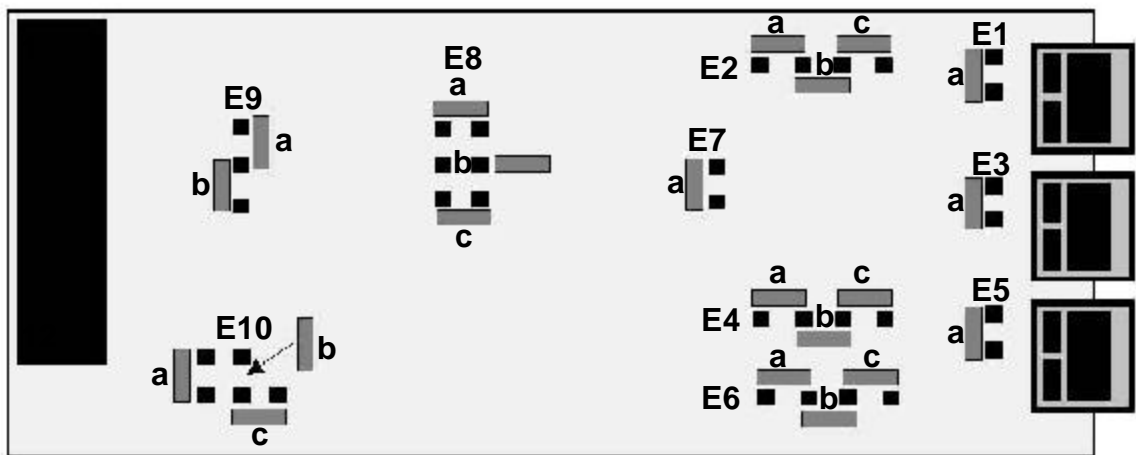

Input Type	Jumper Position		
	E2	E4	E6
Single-ended (signal & return)	a, c	a, c	a, c
Complementary (Differential)	b	b	b

Input Termination (for differential inputs only)	Jumper Position		
	E1	E3	E5
For long input cable runs	a	a	a
For short input cable runs	None	None	None

Input Phase	Jumper Position E7
	Up count, negative transition of B, A positive ( A leads B )
Up count, positive transition of B, A positive ( B leads A )	a

Count by options	Jumper Position E9
X1 = positive edge of A input	None
X2 = positive and negative edges of A input	a
X4 = positive & negative edges of both A & B inputs	b

See "ZERO INDEX SETUP" for jumper locations for zero index signal (Page 35).

## 13.2 QUADRATURE DECODING

The quadrature decoder board generates up(+) and down(-) counts that are arithmetically totaled on the main counter board and then displayed. The decoder board has input circuitry that may be jumpered for either single-ended input signals or balanced line driver signals. It will accept the normal A & B quadrature signals and, if present, a zero index signal. The A & B signals are 90 deg out of phase and the phase relationship of A & B determine whether up counts or down counts are produced. Up counts add to the total and down counts subtract from the total.

Since incremental optical encoders may have a different A & B phase relationship to indicate up and down, the board has a jumper E7 (BPOL) on the B signal to allow selection of the desired phase. Without the jumper, Up output pulses are created when the B signal has a positive transition while the A signal is at a positive level (A leads B). With the jumper installed, Up output pulses are created when the B signal has a negative transition while the A signal is at a positive level (B leads A).

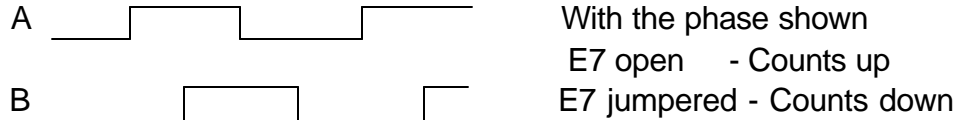

With the opposite phase shown, the effect of E7 reverses.

The board has jumpers that allow counting by 1, 2 or 4 counts per cycle of the A or B signals. The edges that are counted are:

X1 = positive transitions of the A signal.

X2 = positive and negative transitions of the A signal.

X4 = positive and negative transitions of both the A and the B signals.

Digital filtering is provided for the A & B signals to reduce the probability of noise providing false counts.

Some optical encoders create a zero index signal once per revolution that indicates when the encoding wheel is at its zero position. Each time this signal is created, the total count should be a multiple of the number of counts per revolution of the coding wheel. If this feature is enabled in the counter, the counter checks to see if the total counts is an exact multiple of the counts per revolution. If so, it does nothing, and if not, it changes the total to the closest exact multiple. The counts per revolution are entered into the counter via the menu item Pulses. From 0 to 59,999 pulses may be entered. If X2 or X4 counting is enabled on the board, then the value entered into Pulses should be the counts (or pulses) per revolution of the encoder multiplied by this factor of X2 or X4. Also, if Scale is a factor other than 1, include it as a multiplying factor when determining the value of Pulses to enter.. Do NOT include the value of Offset1.

### For example:

If the encoder produces 256 cycles per revolution and X2 counting is selected by a jumper on the board, and from the front panel Menu of the counter, SCALE1 is set to 3 and OFFSET1 is set to 100, then from the front panel menu set PULSES =  $256 * 2 * 3 = 1536$ .

The zero index channel contains the same digital filtering that is provided for the A & B channels. It contains a Polarity jumper that allows selection of either a positive or negative zero index signal. It also contains two Control inputs, C1 and C2 that control the ANDing of the zero index signal with the Channel A and Channel B signals. See “Zero Index Setup” below.

The Item indicator light (center right) may be used to determine the location of the Zero Index. This indicator is lighted while the zero index signal is being received. The zero index signal must be jumpered for the correct polarity. If, during encoder motion, the indicator is on more than it is off, it is likely that the zero index signal is jumpered for the wrong polarity.. If so, add a Polarity jumper to switch E8, position C. If it already has a jumper, remove it.

From the menu, a value may be entered for Offset1. As explained below under “Mechanical Zero”, Offset1 allows a mechanical zero position different from the zero index position. The displayed value is the sum of the following:

1. The total bidirectional counts from the optical encoder since the last counter reset or function reset.
2. The correction factor from the last zero index correction calculation.
3. Offset 1

**For example:**

Suppose that the encoder contains 30 pulses per revolution and X1 counting is used. Further suppose that when the mechanics are at 0 position, the zero index is at 10 and the OFFSET 1 = 10 and the counter is reset when the encoder is at the 5 position.

		Reset						
		v						
Position		0	5	10	20	30	40	50
Index				^			^	
Internal Total	→	0	5	15	25	35	45	
Correction		0	-5	-5	-5	-5	-5	
OFFSET		<u>10</u>	<u>10</u>	<u>10</u>	<u>10</u>	<u>10</u>	<u>10</u>	
Display			10	10	20	30	40	50
Internal Total	←	-5	0	5	15	25	35	45
Correction		-5	-5	-5	-5	-5	-5	-5
OFFSET		<u>10</u>	<u>10</u>	<u>10</u>	<u>10</u>	<u>10</u>	<u>10</u>	<u>10</u>
Display		0	5	10	20	30	40	50

Once the index point has been passed, the display matches the position. Prior to that, the display is in error.

When the counter is displaying Quadrature Total and the Total is reset using the Reset & Peak buttons (Function Reset), the internal Total is set to zero, but the zero index correction is not affected. This results in a display of the correction value plus Offset 1. To zero the internal Total and the correction value, the counter must be reset using the Reset & Menu buttons (Meter Reset). This results in a display of OFFSET 1.

### 13.3 ZERO INDEX SETUP

The relationship between the zero index correction signal and the Channels A & B signals varies with different encoder model numbers and different manufacturers. To accommodate this variation, the Quadrature board has control jumpers and selectable outputs that provide ANDing of the zero index signal with all possible combinations of the Channel A & B signals.

Consider a typical encoder model that produces the waveforms shown below. Assume X4 counting is selected. The count increases and decreases on each A & B transition and remains steady between transitions. The counts shown below the waveforms represent the effect of the zero index correction ZI if no ANDing is used. Note the difference in count in the regions between transitions when counting up and then counting down. The zero index correction is made on the leading edge transition of the zero index signal. When counting down, the leading edge is the trailing edge of the signal shown below because time is increasing from right to left.

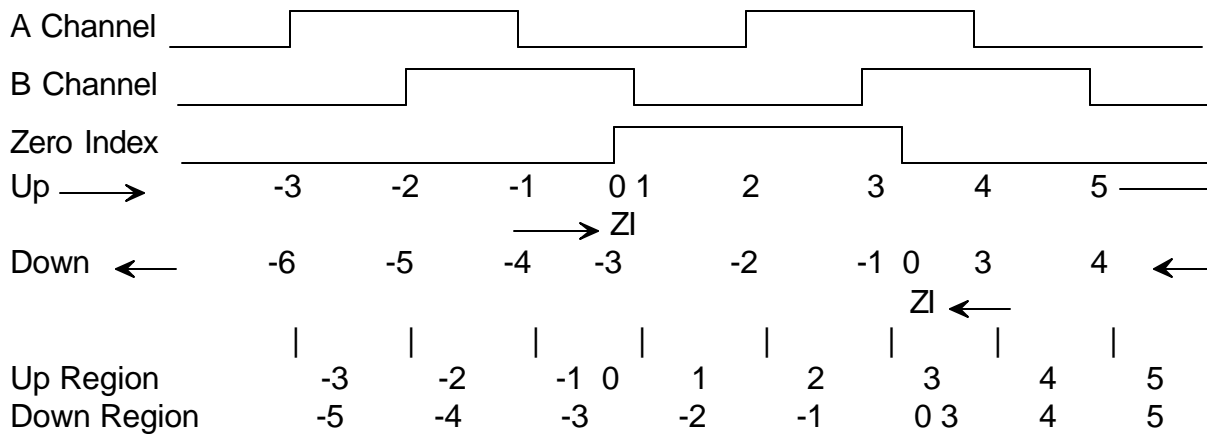

It follows that a wide zero index signal causes a discrepancy in the count in the regions between transitions when counting up and counting down. To correct this situation, AND the zero index signal with the A & B channel signals. Assume for this example the zero index is ANDed with the inverse of A ( $\bar{A}$ ) and the inverse of B ( $\bar{B}$ ) to produce ZIY as shown below.

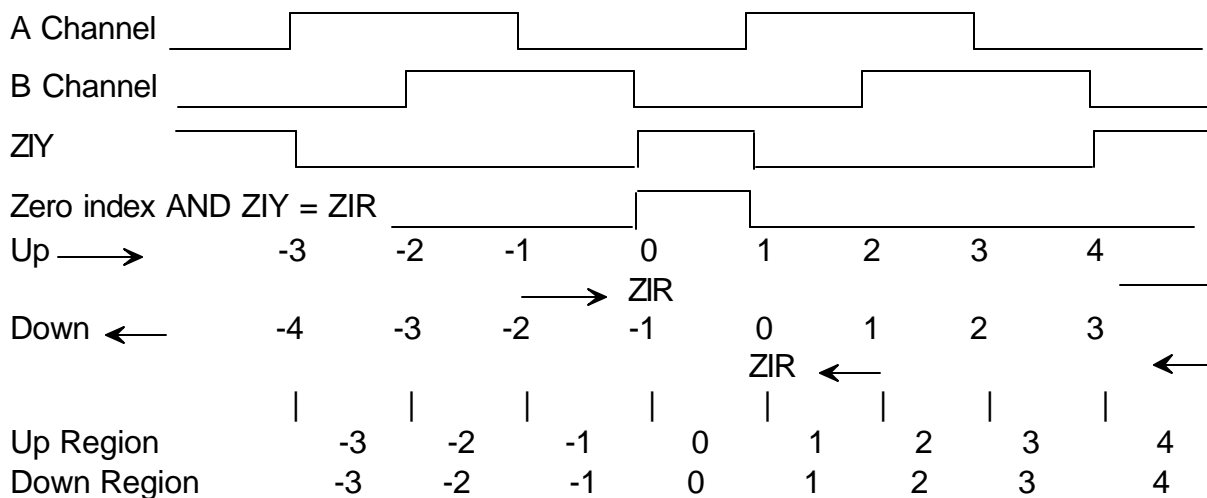

By ANDing the zero index signal with the A & B channels, there is no regional discrepancy

between counting up and counting down.

There are 2 control signals, C1 and C2, and 3 outputs, ZI, ZIX and ZIY that may be jumpered to provide 8 selections of ANDed signals or the zero index signal without ANDing.

Zero Index Polarity	Jumper Position	
	E7	
Positive	a	
Negative	None	

Zero Index ANDing	Jumper Position	
	E10	E8
Zero Index (no ANDing)	c	-
Zero Index AND /A	a	-
Zero Index AND /B	a	a
Zero Index AND A	a	b
Zero Index AND B	a	a, b
Zero Index AND /A AND /B	b	-
Zero Index AND /A AND B	b	a
Zero Index AND A AND /B	b	b
Zero Index AND A AND B	b	a, b

The manufacture's data sheet for the optical encoder will show the position and width of the zero index signal with respect to the A channel and B channel signals. Selection of one of the above combinations depends on that relationship and the polarity of the channel A & B signals when the mechanical position is zero. Be sure to take into account the selected phase relationship determined by the presence of or absence of jumper E7-a (BPOL). Jumper E7-a is selected to cause the display to count in the proper direction. If jumper E7 is in place, the channel B signal will have the opposite polarity from the channel B output of the encoder.

### 13.4 MECHANICAL ZERO

By using the Counter's OFFSET1 value, it is possible to place the mechanical zero (zero counter reading) at some point other than the location of the zero index. The following technique describes how to accomplish this.

1. Set the E8 & E10 jumpers as described above to produce the desired Zero Index signal.
2. Set OFFSET1 = 0.
3. Reset the counter (counter reset).
4. Rotate the optical encoder in the positive direction until the reading jumps to zero at the zero index point (Item indicator lights).
5. Reverse the direction of rotation until the desired zero mechanical position is reached.
6. Note the reading and enter that reading into OFFSET1 using the opposite polarity of the display.
7. Reset the counter and it will display the OFFSET1 value because the internal total

counter=0 and the correction=0. The position of the encoder when the counter is reset is not critical.

8. Rotate the optical encoder past the zero index point to set the internal correction.
9. Return to the desired zero mechanical position and verify a zero reading.

This completes the procedure. If the encoder is rotated back to mechanical zero, it should read zero.

Note: Any time the counter is powered up or reset, the optical encoder should be rotated past the zero index point one time to set the internal correction

If no zero index signal is available from the optical encoder, perform the following procedure.

1. Remove any E10 jumpers to eliminate the Zero Index signal.
2. Set OFFSET1 = 0.
3. Adjust the optical encoder to the mechanical zero position and with it in this position, reset the counter.

### 13.5 SETUP SUMMARY

Summarizing the complete setup procedure:

1. Set the input signal jumpers.
  - A. For single-ended signals such as TTL or CMOS, use jumpers c of E2, E4 and E6 and jumper a of E6. Input signals are applied as follows:
    - Channel A, P5-1X (AH)
    - Channel B, P5-3Y (BH)
    - Channel Z, P5-5Z (ZH) Zero Index
    - Ground, P5-6Z
  - If an excitation voltage is required, use jumper a of E2 and jumper a of E4
  - B. For differential line driver or balanced input signals, use jumper b for E2, E4 and E6. If 120 ohm line termination resistors are desired, place jumpers E1, E3 and E5.
2. Set the correct counting direction by placing or omitting the Channel B polarity jumper E7.
3. Choose X1, X2 or X4 counting and omit a and b of E9 for X1, place a of E9 for X2 or place b of E9 for X4. Determine the scale factor to be used by the counter and set SCALE1 to this value using the counter Menu. Most often it will be set to 1.00000 with a multiplier of 1.
4. If the Zero Index is to be used, do the following:
  - A. Temporarily place jumper c of E10 and rotate the encoder while watching the Item indicator of the display. If it is OFF most of the time, the Z polarity is correct. If it is ON most of the time, the Z polarity is incorrect, so add jumper c of E8 if it is missing, or remove jumper c of E8 if it is in place.
  - B. From the manufacturer's specifications for the encoder showing the relationship of the Zero Index signal to the Channel A and Channel B signals, determine from the table above the desired positions of jumpers a and b of E8 and a, b or c of E10. If not

- used here, remove jumper c of E10 that was placed for the test in A. above.
- C. From the manufacture's specifications for the encoder, determine the number of cycles per revolution. Multiply this by 1, 2, or 4 depending on the selection of X1, X2 or X4 counting and multiply that result by the counter scale factor. Put the final result in the counter Menu item, PULSES.
5. Finally, follow the procedure outlined above under the heading titled, MECHANICAL ZERO.

### 13.6 MANUFACTURER'S OF OPTICAL ENCODERS

#### ALLENBRADLEY

##### Current Sink, Open Collector and Line Driver CCW rotation

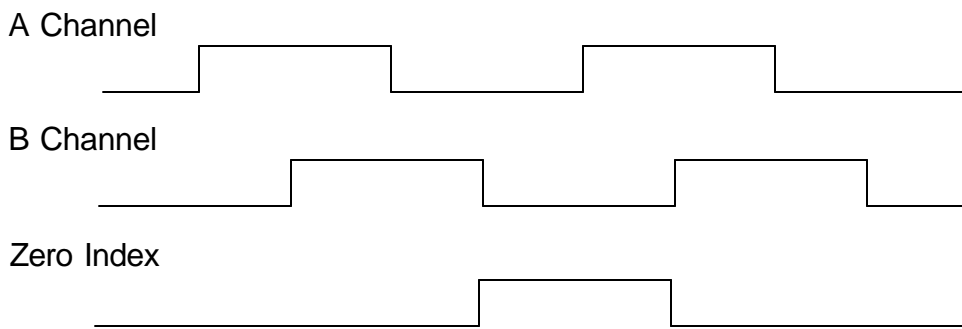

##### Current Source CCW rotation

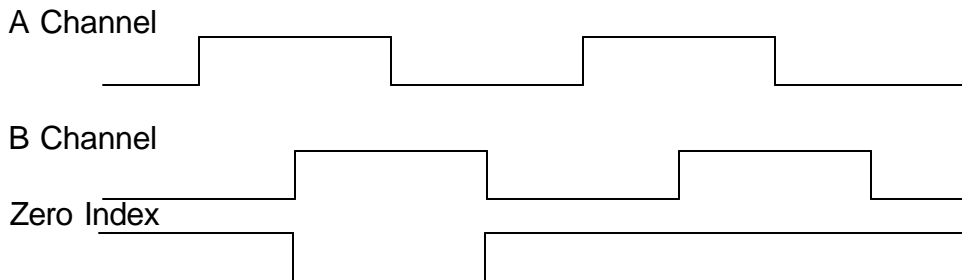

#### BEI

##### Models H25, L25, E25, MOD5500, MOD5600 CCW rotation viewing shaft end

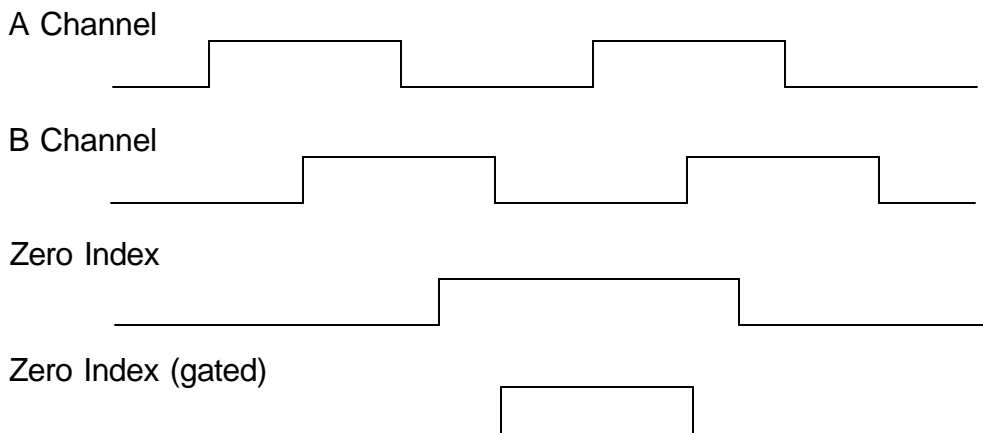

**Models MX-15, MX-21 CCW rotation**

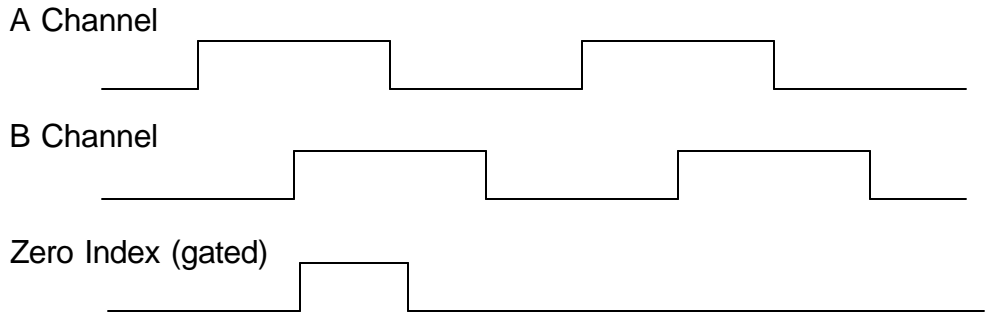

**Models E20, E11, E15, CMX216, MOD900 CW rotation**

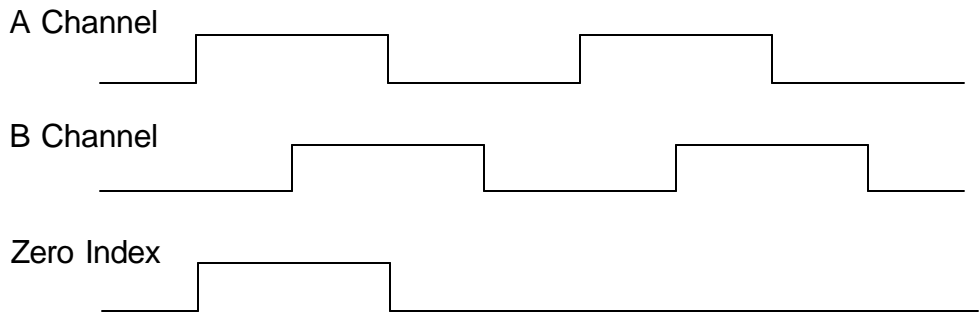

**BOURNS  
EN Series**

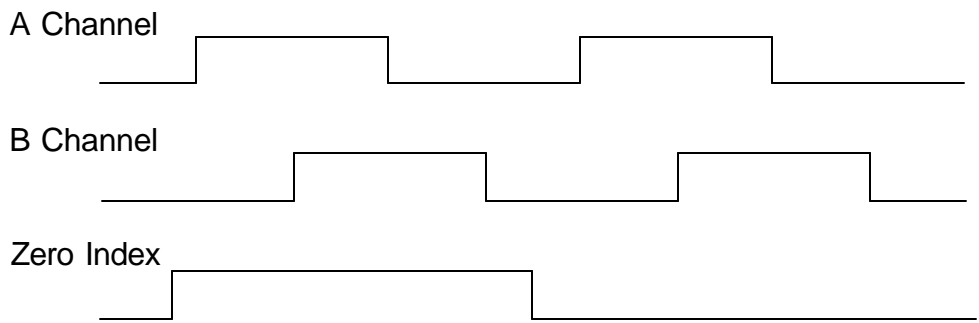

**COMPUTER OPTICAL PRODUCTS  
Models CP-350, CP-360, CP-370, CP-850, CP-870 CW rotation viewing shaft end**

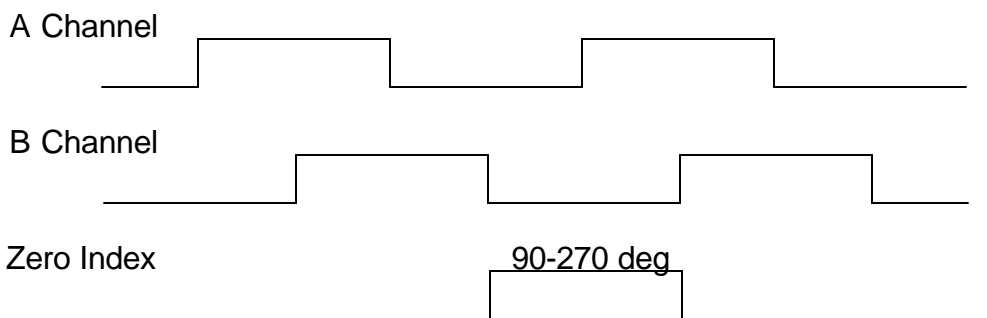

**ENCODER PRODUCTS CO.**



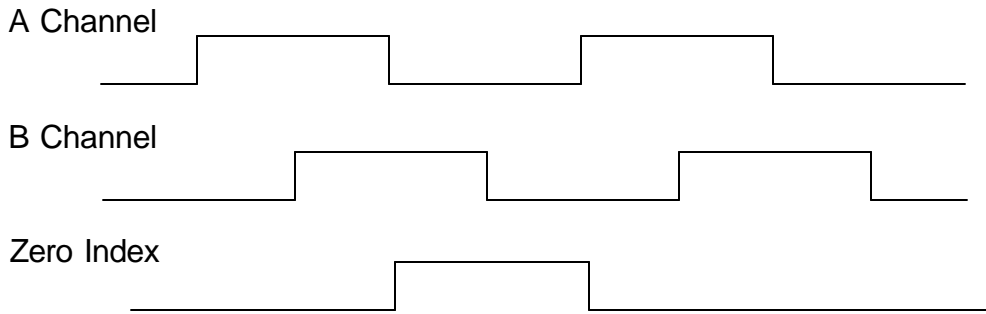

GRAYHILL CW rotation

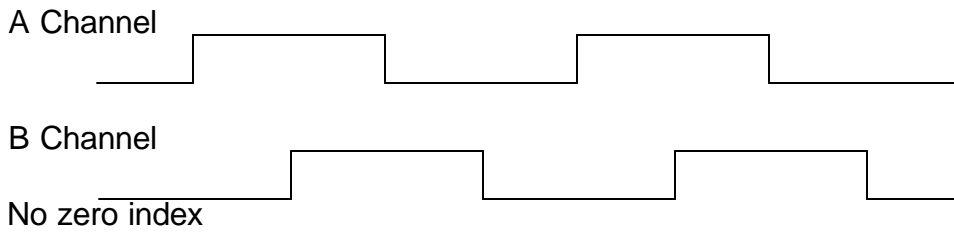

OAK-GRIGSBY CW rotation

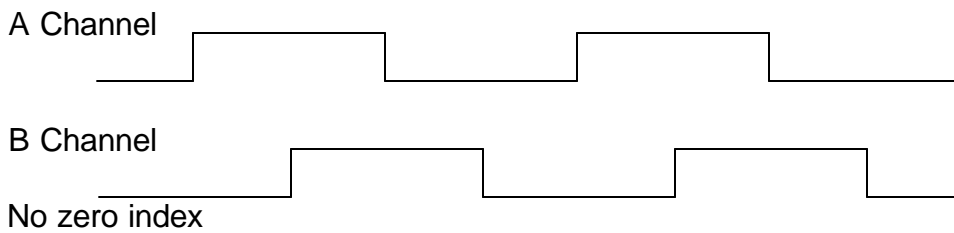

### 13.7 QUADRATURERATE

Rate and direction may also be displayed using an extended version of the counter. Using quadrature to determine rate not only has the advantage of displaying direction but also eliminates errors due to vibration and jitter that cause erroneous readings in standard rate meters. The meter uses A-B to display quadrature rate. Scale 1 is used to set A to the proper value and scale 2 is set to identical values. Rate (I1) is the difference between Channel A and Channel B.









# 14.

## DUAL ALARM OUTPUTS

### 14.1 OPERATING MODE MENU SELECTION

When setting up the meter, it may be necessary to enable some of the menu items. See Section 10 for further information.

MENU KEY	DIGIT SELECT KEY	VALUE SELECT KEY
----------	------------------	------------------

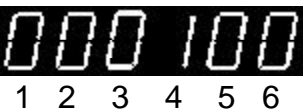
 <p>Press the  key until SourcE (Source of Alarm signal) is displayed. See Section 10, ALSEt for detailed selection information for Digits 1 through 6.</p>	 <p>Press  to display status. Press  again to select digit. Selected digit will flash.</p>	 <p>Press  to select value for flashing digit  <b>Digit 5:</b> Source for comparison of Alarm 1  <b>Digit 6:</b> Source for comparison of Alarm 2</p>
 <p>Press the  key until ALSEt (Alarm setup) is displayed. See Section 9, ALSEt for detailed selection information for Digits 1 through 6.</p>	 <p>Press  to display status. Press  again to select digit. Selected digit will flash.</p>	 <p>Press  to select value for flashing digit  <b>Digit 2:</b> Relay out status when Alarm active  <b>Digit 3:</b> Latching or nonlatching alarm  <b>Digit 4:</b> Alarm status  <b>Digit 5:</b> Deviation or Hysteresis  <b>Digit 6:</b> Time delay</p>
 <p>Press the  key until Deviation 1 or 2 (Band deviation or Hysteresis) is displayed.</p>	 <p>Press  to display status. Press  again to select digit. Selected digit will flash.</p>	 <p>Press  to select value for flashing digit</p>



















### 14.2 DEVIATION AND HYSTERESIS MODE

In the deviation and hysteresis mode of operation, if the value of Deviation 1 (controls Alarm 1) and Deviation 2 (controls Alarm 2) are set to zero, the alarms operate in the normal on/off mode. When a value other than zero is entered, if band deviation is selected in Alarm setup, then the alarm energizes when the displayed value exceeds the setpoint by the amount entered

in Deviation. In the Hysteresis mode, the Alarm energizes above (or below) the setpoint by the amount entered in deviation and deenergizes below (or above) the setpoint by the same amount

### 14.3 VIEWING AND CHANGING SETPOINTS

When viewing or changing the setpoint values, it is not necessary to enter the setup menu. This allows the meter to continue conversions and provide outputs when the setpoints are displayed.

<b>ALARM KEY</b> 	<b>DIGIT SELECT KEY</b> 	<b>VALUE SELECT KEY</b> 
		
Press the  key to display Alarm 1 value.	Alarm value blinks and Alarm 1 LED indicator lights. Press  to select digit.	Using  to select digit and  to set digit value, enter setpoint 1 value.
		
Press  key again to display Alarm 2 value	Alarm value blinks and Alarm 2 LED indicator lights. Press  to select digit.	Using  to select digit and  to set digit value, enter setpoint 2 value.
	Press  key again. The meter resets and then displays the present reading.	

## 15.

### RS-232 AND RS-485 INTERFACE

#### 15.1 JUMPER SELECTION

##### RS232

**Jumper g** - installed for normal operation

**Jumper h** - installed when used as slave display

**Jumper j** - provides pull up resistor on RTS line

Shipped with jumpers g and j installed

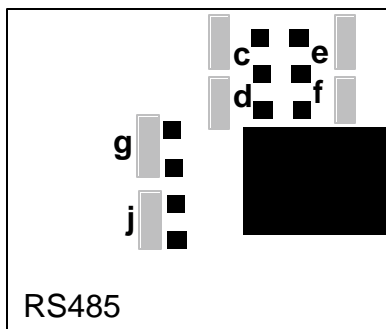
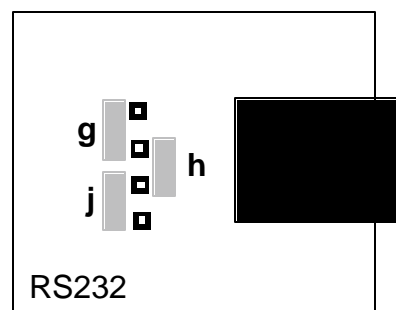

##### RS485

**Jumper g and j** - add 121 ohm load resistors and are installed with long cables. If multiple meters are on same line, only the last meter in the line should be jumpered.

























**Jumper d and f** - installed for full duplex operation

**Jumper c and e** - installed for half duplex operation

Shipped with jumper d and f installed.

## 15. 2 OPERATING MODE MENU SELECTION

The following menu items are accessible only with an RS-232 or RS-485 option installed and appropriate lockouts enabled. See Section 9 for further information.

MENU KEY 	DIGIT SELECT KEY 	VALUE SELECT KEY 
<p></p> <p>Press the  key until SEr 1 (Serial interface setup 1) is displayed.</p>	<p> 1 2 3 4 5</p> <p>Press  to display status. Press  again to select digit. <b>Digit 3:</b> Output filtering</p> <p><b>Digit 4:</b> Baud rate <b>Digit 5:</b> Output update rate</p>	<p> 1 2 3 4 5</p> <p>Press  to select value for flashing digit</p> <p><b>3:</b> "0"- Send unfiltered signal "1"- Send filtered signal <b>4:</b> "0" to "6" - 300 to 19.2k <b>5:</b> "0" to "8" 60Hz to rate/256</p>
<p></p> <p>Press the  key until SEr 2 (Serial interface setup 2) is displayed.</p>	<p> 1 2 3 4 5 6</p> <p>Press  to display status. Press  again to select digit. <b>Digit 2:</b> Line feed</p> <p><b>Digit 3:</b> Alarm data sent with meter readings <b>Digit 4:</b> Control of output <b>Digit 5:</b> Meter address</p>	<p> 1 2 3 4 5 6</p> <p>Press  to select value for flashing digit</p> <p><b>2:</b> "0"-no line feed "1"-&lt;LF&gt; after &lt;CR&gt; <b>3:</b> "0"-no alarm data "1"-alarm data sent <b>4:</b> "0"-continuous output "1"-output on command <b>5:</b> "1" to "F" = 1 to 15 "0." to "F." = 16 to 31 Meter #16 to Meter #31</p>
<p></p> <p>Press the  key until SEr 3 (Serial interface setup 3) is displayed.</p>	<p> 1 2 3 4 5 6</p> <p>Press  to display status. Press  again to select digit. <b>Digit 2:</b> RS485 full or half duplex <b>Digit 3:</b> Meter recognition character <b>Digit 4:</b> RS232 RTS type</p> <p><b>Digit 5:</b> Carriage return (and LF if selected) <b>Digit 6:</b> Data sent via communications (only 1 item allowed if BCD)</p>	<p> 1 2 3 4 5 6</p> <p>Press  to select value for flashing digit</p> <p><b>2:</b> "0"-Full duplex "1"-Half duplex <b>3:</b> "0"- "*" character "1"-Custom character <b>4:</b> "0"-Nonlatching RTS "1"-Latching RTS <b>5:</b> "0" - End of all items "1" - At end of each item <b>6:</b> "0" - All active items sent "1" - Item 1 only "2" - Item 2 only (if active) "3" - Item 3 only (if active) "4" - Peak value "5" - Active items +Peak</p>

## 16.

# ANALOG OUTPUT

The analog output option provides a 0 to 20mA and a 0 to 10Vdc linear signal derived from the displayed reading. The low signal output and high signal output may be set to equal any displayed value. Although both outputs are available, only one is calibrated to specifications. The other output is accurate to +/-1% of the displayed value typical (2%max). To select which output is calibrated, install jumpers per Section 19. 1.

### 16.1 4 TO 20MA OUTPUT SCALING

The output is scaled by selecting a displayed value for the low signal output and a displayed value for the high signal output. For a current output, the low value is 0mA and the high output is 20mA. To scale a signal for 4 to 20 mA, the following procedure must be used:

1. Desired display value for 20mA - Desired display value for 4mA = Display span
2. Display span / 4 = Offset value
3. Desired display value for 4mA - Offset value = **An Lo**
4. **An Hi** = Desired display value for 20mA

### 16.2 ANALOG OUTPUT SETUP SOFTWARE

The following menu items are accessible only with an Analog Output option installed and appropriate lockouts enabled. See Section 10 for further information. Setup Example: 4mA to 20mA out = 5000 counts to 15000 counts (See Section 19.2).



MENU KEY	DIGIT SELECT KEY	VALUE SELECT KEY
<div style="text-align: center; border: 1px solid black; padding: 2px; margin-bottom: 5px;"><b>An SET</b></div> <p>Press the  key until An Set (Setup of analog output) is displayed. See Section 9, An Set for detailed selection information for Digits 1 through 6.</p>	<div style="text-align: center; border: 1px solid black; padding: 2px; margin-bottom: 5px;"><b>00</b></div> <p>Press  to display status. Press  again to select digit. Selected digit will flash.</p>	<div style="text-align: center; border: 1px solid black; padding: 2px; margin-bottom: 5px;"> <b>12</b>  <small>1 2 3 4 5 6</small> </div> <p>Press  to select value for flashing digit <b>Digit 5:</b> Current or Voltage <b>Digit 6:</b> Source for analog output.</p>
<div style="text-align: center; border: 1px solid black; padding: 2px; margin-bottom: 5px;"><b>An Lo</b></div> <p>Press the  key until An Lo (Displayed value at 0mA or 0V) is displayed.</p>	<div style="text-align: center; border: 1px solid black; padding: 2px; margin-bottom: 5px;"><b>00000</b></div> <p>Press  to display value. Press  again to select digit. Selected digit will flash.</p>	<div style="text-align: center; border: 1px solid black; padding: 2px; margin-bottom: 5px;"><b>02500</b></div> <p>Press  to select value for flashing digit</p>
<div style="text-align: center; border: 1px solid black; padding: 2px; margin-bottom: 5px;"><b>An Hi</b></div> <p>Press the  key until An Hi (Displayed value at 20mA or 10V) is displayed.</p>	<div style="text-align: center; border: 1px solid black; padding: 2px; margin-bottom: 5px;"><b>00000</b></div> <p>Press  to display value. Press  again to select digit. Selected digit will flash.</p>	<div style="text-align: center; border: 1px solid black; padding: 2px; margin-bottom: 5px;"><b>15000</b></div> <p>Press  to select value for flashing digit</p>

## 17.

# PARALLEL BCD OUTPUT

### 17.1 OPERATING MODE MENU SELECTION

The following menu items are accessible only with a BCD option installed and appropriate lockouts enabled. See Section 10 for further information.

MENU KEY	DIGIT SELECT KEY	VALUE SELECT KEY
		
<p>Press the  key until SEr 1 (Serial interface setup 1) is displayed.</p>	<p>Press  to display status. Press  again to select digit. Selected digit will flash.</p> <p><b>Digit 3:</b> Output filtering</p> <p><b>Digit 5:</b> Output update rate</p>	<p>Press  to select value for flashing digit</p> <p><b>3:</b> "0"-Send unfiltered signal "1"-Send filtered signal</p> <p><b>5:</b> "0"-Line frequency "1" to "9" - Batch display rate (3.5/sec) to Batch display rate / 256 (1 every 15 min.)</p>

### 17.2 BCD OUTPUT LEVELS

The BCD option provides isolated, buffered, stored, 3-state parallel outputs that are selectable for either 0 to 5V logic levels (LSTTL, CMOS compatible) or 0 to 15Vdc. Selection jumpers are located on the BCD board. BCD outputs are positive true. Polarity bit is positive true for +sign.

LOGIC LEVEL	JUMPER REQUIRED
0 to 5Vdc	b
0 to 15Vdc	a

### 17.3 BCD CONTROL SIGNALS

**Enable**      Logical 0 - All outputs go to the high impedance state  
                  Logical 1 - BCD information is available at outputs.

**BCD Hold**    Logical 0 - BCD from last update prior to BCD Hold going low is stored  
                  Logical 1 - BCD information updates at selected rate.

**Data Ready** Logical 0 - BCD outputs are valid  
                  Logical 1 - BCD outputs are not valid

18.

**5, 10 AND 24 VDC EXCITATION OUTPUTS**

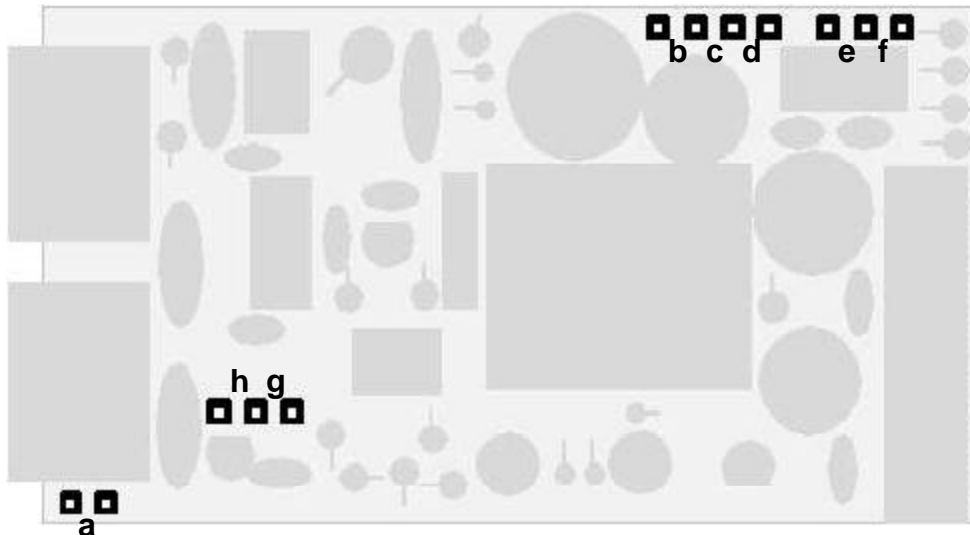
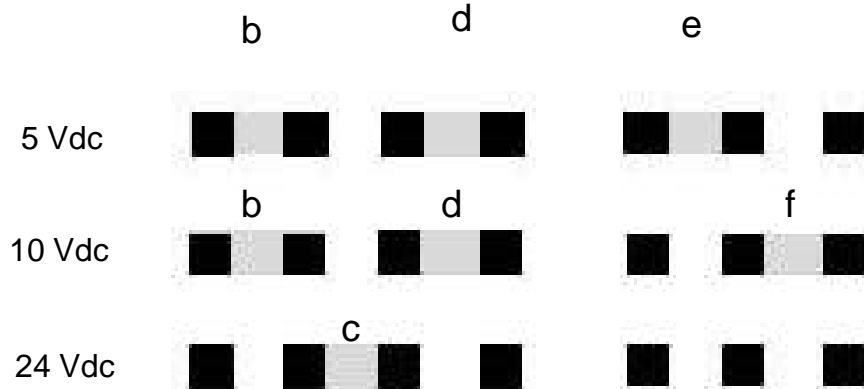

Figure 18. 1 - Power Supply

- Jumper ' a ' - Front panel menu lockout (see Section 9.1)
- Jumper ' h ' - External Input B at output connector P1 - 4
- Jumper ' g ' - +5V at output connector P1 - 4

**18. 1 SELECTION OF 5, 10 OR 24VDC OUTPUT**

Voltage Output	Jumper Locations
5 Vdc	b, d and e
10 Vdc	b, d and f
24 Vdc	c



**Note:** The excitation power supply is floating with respect to meter ground. When powering transducers that have a common signal low and power supply return lead, jumper minus excitation to signal ground.

### 19.1 FUNCTION OF DIGITAL INPUTS

**Meter Reset** Logical 0 - The microcomputer reads and resets the meter to the values stored in nonvolatile memory. If totals are saved on power down, totals are reset to the saved value, otherwise totals are set to zero or to the offset value if offset is not zero.

**Function Reset** Logical 0 - All totals are reset to zero or to the offset value if offset is not zero, alarms are reset and peak display resets to minus overload

**Peak Display** Logical 0 - The peak value of the filterable item is displayed  
Logical 1 - The present value the selected item is displayed.

**Hold** Logical 0 - The meter display and outputs are held at the last reading prior to the hold going low. Meter continues to totalize while meter is in hold  
Logical 1 - The display and outputs are updated normally

**External Gate** Logical 0 - The gate time starts when input goes low and ends when gate time goes high  
Logical 1 - When external gate is selected, it overrides the internal gate. At power on, the meter displays reset until the external gate input goes low and then high to complete a conversion. The new value will then be displayed until a new external gate occurs.

**Display Blank** Logical 0 - The display and indicator lights are blanked  
Logical 1 - The display and indicator lights are lit.

**External Gate** Logical 0 - Gate Time is closed  
Logical 1 - Gate time is open and remains open until logical 0 applied

#### Display Item 2 & Display Item 3

Inputs A & B Logical 0 or 1 - Item 1 displayed  
Input A Logical 0 and Input B Logical 1 - Item 2 displayed  
Input B Logical 0 and Input A Logical 1 - Item 3 displayed



20.

**CALIBRATION**

All ranges of the meter have been digitally calibrated at the factory prior to shipment. The calibration equipment is certified to NIST standards. Calibration constants are stored in nonvolatile memory in EEPROM on the main board, the V-to-F signal conditioner and on the analog output board. The crystal on the main board is calibrated via the menu item "calib". Using an accurate, known frequency, the meter is calibrated by entering the error of the in parts per million. If the frequency reading is high, the value entered is negative and if the reading is low, the value is positive.

For the customer requiring on site calibration, an RS-232 or RS-485 option must be installed to perform the calibration. The interface card may be temporarily installed and then removed upon completion of calibration. Software for calibration of the V-to-F and analog output boards is available from the factory.

21.

**SPECIFICATIONS**

**BASIC METER**

**Display**

Type ..... 6 LED, 7-segment, 14.2mm (.56") high digits & 4 LED indicators  
Color ..... Red or green  
Range ..... -999999 to +999999

**A to D Conversion**

Technique (frequency) ..... 1/period  
Rate ..... Gate Time + 30 mS + 2 periods  
of the input signal (max.)  
Gate Time ..... Selectable 0 to 199.99 sec.  
Zero Wait Time ..... Selectable 0 to 199.99 sec.  
Output & Display Update Rate ..... same as conversion rate

**Noise Rejection**

CMV from DC to 60 Hz ..... Safety-rated to 250Vac, 4.2kVp per High Voltage Test  
CMR from DC to 60 Hz ..... 130 dB

**Dual Channel Signal Conditioner**

Types ..... AC or Pulses from NPN, PNP xistors, contact closures,  
magnetic pickups, etc.  
Channel A ..... 0 to 1 MHz  
Channel B ..... 0 to 250 kHz

Isolation .....channel A & channel B share common ground  
 Selectable Low Pass Filter ..... 1600 Hz  
 Hysteresis .....selectable from 15 mV to 2.2 Vp-p  
 Trigger level ..... selectable from 0 V to +/-1.7 V  
 Debounce Circuitry .....selectable 0, 2, 10, 80 mS

**V-to-F Signal Conditioner**

Inputs

Signal levels ..... 0 to 1 mA, 4 to 20 mA, 0 to 10 V  
 for other ranges, consult factory

Accuracy

Accuracy at 25 degrees C ..... 0.025%  
 Span Tempco ..... 0.003% R/°C  
 Zero Tempco ..... 0.003%FS/°C

**POWER SUPPLIES**

Input Voltage (std) .....85 to 264 Vac, 90 to 370 Vdc  
 Input Voltage (opt) .....8 to 28 Vac, 9 to 37 Vdc  
 Frequency ..... DC and 47 to 440 Hz  
 Consumption..... 5.3 Watts max.

Excitation Power Supplies

Outputs ..... 5 Vdc, 5%, 100 mA max  
 10 Vdc, 5%, 120 mA max.  
 24 Vdc, 5%, 40 mA max.

Ripple ..... 100 mVp max.

Isolation ..... Safety-rated to 250Vac, 4.2kVp per High Voltage Test

**DUAL CONTROLLER OPTION**

**Basic**

Power ..... Provided by basic meter  
 Update Rate ..... at meter conversion rate  
 Setup ..... setpoint values may be entered by front

panel pushbuttons or via RS-232 or RS-485

Lockouts ..... Front panel pushbuttons control display and change of  
 setpoints, only control display of setpoints, or are disabled.

Output Operation ..... either output may be set to operate above or below  
 the setpoint, latching or nonlatching or output disabled

Filtering ..... comparison to the setpoints may be either  
 from the filtered or unfiltered input signal

Time Delay ..... selectable time delay of output status  
 change of 1 to 128 readings

## Alarm Status Indicators

Type .....2 red LED lamps  
Setup ..... either indicator may be set to light when the  
output is on or off or may be disabled

## Relay Output

Contact Rating ..... 10 A @ 240 Vac, 8 A @ 24 Vdc  
Safety Certification.....VDE, UL, and CSA  
Isolation  
Coil to Contacts ..... Safety-rated to 250Vac, 4.2kVp per High Voltage Test  
Between Open Contacts ..... withstand 1000 Vrms  
Pickup .....26 ms typ.  
Release .....22 ms typ.

## Solid State Relay Output

Voltage Rating ..... 125Vac, 150 Vdc max.  
Current Rating ..... 120 mAac, 240mAdc  
Safety Certification.....VDE, UL and CSA  
Isolation ..... Safety-rated to 250Vac, 4.2kVp per High Voltage Test  
Response to input signal ..... 17 ms typ.

## ANALOG OUTPUT OPTION

Isolation ..... withstand 3750 Vrms, 8mm creepage  
Power ..... supplied by basic meter  
Accuracy..... basic meter +/-0.05% Analog Full Scale  
Response Time ..... 17 ms for unfiltered input, same as basic meter for filtered input  
Compliance  
0 to 20 mA ..... 16 V (0 to 600 Ohms)  
0 to 10 V ..... 2 mA (5 kOhms min.) load  
Scaling  
Reading for Zero Output .....-99,999 to +99,999  
Reading for Full Scale Output ..... -99,999 to +99,999

## RS-232 / RS-485 INTERFACE OPTION

Isolation ..... Safety-rated to 250Vac, 4.2kVp per High Voltage Test  
Power ..... supplied by basic meter  
Type ..... full duplex (RS-485)  
Baud Rates .....300, 600, 1200, 2400, 4800, 9600, 19200  
Signal Levels .....Meet RS-232 and RS-485 standards

## BCD OUTPUT OPTION

Isolation ..... Safety-rated to 250Vac, 4.2kVp per High Voltage Test  
Power ..... supplied by basic meter  
Type ..... 3-state, stored, parallel  
Signal Levels ..... LSTTL, CMOS compatible  
Controls ..... BCD Enable, Hold, Data Ready

## ENVIRONMENTAL

Operating Temperature ..... 0°C to 55°C  
Storage Temperature ..... -40°C to 85°C  
Relative Humidity ..... 90% from 0°C to 40°C

22.

## GLOSSARY OF TERMS

### Calibration

A menu item that compensates for any error in the crystal oscillator in the meter. With an accurate, known frequency input, a value in parts per million is entered equivalent the error in parts per million of the input signal. If the displayed reading is lower than the actual signal input, a positive value is entered. If the displayed reading is higher, a negative value is entered.

### Calculated Total

In most cases, total is calculated by directly counting the number of pulses of the input signal and applying a scale factor to read in engineering units. Some totals (Total A, Rate A) are calculated totals. In these cases, the meter determines the rate of the input signal and multiplies by the time between rate conversions to calculate total. The scale factor for total is based on the displayed value of rate. A scale of 1 always produces a total at the end of 1 second equal to the displayed rate. For a display of 300 where the rate is equivalent to gallons per second, a scale factor of 1 produces a total that at the end of 1 second is 300, 2 seconds 600, etc. However, if the displayed rate is 300 gallons per minute, then the scale factor must be 1.66667 with a multiplier of .01 ( a multiplier of 1/60 since the rate value is in minutes) to produce a total at the end of 1 minute of 300, at 2 minutes 600 etc.

### Coordinates of 2 Points

Instead of using scale and offset to display in engineering units, the coordinates of 2 points may be used. The low input is entered as frequency in Hertz for the lowest frequency input to the meter and low reading is entered as the value to be displayed at that frequency. High input is entered as frequency in Hertz for the highest frequency input to the meter and high reading as the value to be displayed at that frequency.

### Custom Curve

In the extended version of the counter, the unit is capable of linearizing the input signal by using the software provided and loading the values into

EEPROM via the serial communications. Up to 240 data points may be entered into a test file with one set of values equivalent to input signal and the second set of values the desired display at that input.

<b>Deviation</b>	Either alarm may operate in the deviation mode. In the menu item "deviation", a value is entered equivalent to the amount above and below the setpoint at which the alarm operates. For example, if the value entered is 100, and the setpoint value is 1000, the alarm would energize above 1100 and below 900.
<b>Frequency</b>	The meter is calibrated such that a scale factor of 1 and offset of 0 causes the input to the meter to display directly in Hertz with a resolution of 1 Hz. To increase or decrease the resolution, the scale factor multiplier may be increased or decreased.
<b>Gate Time</b>	The Gate Time determines the update time of the display. The longer the time, the slower the outputs and display are updated, but in most modes, the longer the Gate Time, the more cycles of the input signal that are averaged to produce the reading. In the total mode, the gate is always open, but the gate time setting still determines the update rate of the meter. The actual conversion rate of the meter is the Gate Time + 1 period of the input signal. At very low frequencies, the update rate of the meter becomes slow due to the period of the input exceeding the Gate Time.
<b>Hysteresis</b>	Either alarm may operate in the hysteresis mode. In the menu item "deviation", a value is entered equivalent to the amount above and below the setpoint at which the alarm operates. For example, if the value entered is 10, and the setpoint value is 1000, if the alarm is set to energize above the setpoint, the alarm would energize above 1010 would not deenergize until the displayed value goes below 990. This mode reduces relay chatter and excessive cycling of the load.
<b>Item</b>	Item refers to the display Item number. For example, in Total A+B, the sum of A + B is Item #1, Total A is Item #2 and Total B is Item #3. When the meter is reset, Item #1 is always displayed, to view another Item, depress and release the reset button. When Item 1 is displayed, the yellow view (V) LED is out item 2 the LED is lit, and item 3 the LED flashes.
<b>Offset</b>	An offset value from -999,999 to 999,99 may be entered in the offset menu item. The offset may be used in the totalize mode as a preset value and the total is counted down from the preset to zero.
<b>Period</b>	Period is the time of one complete cycle of the input frequency. A scale factor of 1 and multiplier of 1 produce a display in microseconds.
<b>Quadrature</b>	A quadrature encoder generates 2 signals 90 degrees out of phase. The phase relationship depends on the direction of rotation of the encoder. The meter counts up or down depending on the phase. Quadrature is used to determine length or position.

<b>Phase Angle</b>	In this mode, the meter determines the phase angle between the signals on Channel A and Channel B. The phase angle is measured from 0 to 360 degrees
<b>Pulses</b>	The menu item pulses is used to set the number of pulses generated by a quadrature encoder for each zero index pulse. The setting is equal to the number of pulses per revolution of the encoder (times 2 or 4 if the count by 2 or 4 is selected on the signal conditioner) times the scale factor.
<b>Rate</b>	This is the same as frequency except that a scale factor is applied to the input signal to display in engineering units such as RPM, gallons per hour, etc.
<b>Resolution</b>	This is a menu item that controls the resolution of the arithmetic functions (A+B, A-B, AxB, A/B, A/B-1). The displayed value may be multiplied by 0.00001 to 100,000 in decade steps.
<b>Scale</b>	Scale is the menu item that allows an input to be scaled in engineering units. The scale factor consists of two parts; the scale factor is a multiplier that may be set from 0.00001 to 9.99999 and a multiplier from 0.00001 to 100,000 in decade steps. When scale is selected, the most significant digit flashes allowing the value of that digit to change, pushing the digit select key moves the flashing digit to the right. When the right hand digit is flashing, pushing the digit select key again causes the multiplier to be displayed. Pushing the value select key changes the value of the multiplier. The next time the digit select key is depressed, the display goes back to the scale factor.
<b>Time Interval</b>	Time interval is the measure of time between the occurrence of a pulse on Channel A and Channel B. The time may be measured from the leading or trailing edge of the pulse on A to the leading or trailing edge of the pulse on B.
<b>Time Out</b>	When making conversions, the gate time is started on an edge of the input signal and ended on the same edge. If no input is received, the meter will never update. The time out setting allows a wait time from .01 seconds to 199.99 seconds for the meter to receive a signal. At the end of time out, the meter updates and displays 0. The longer the time out, the lower the displayed value of the input frequency. A shorter time out allows the meter to update at a higher rate.
<b>V-to-F Converter</b>	The voltage to frequency converter takes voltage or current inputs (0 to 1mA, 4 to 20mA, 0 to 10V) and converts them to a frequency. This allows the meter to totalize an analog input as well as displaying rate. In addition, for differential pressure transducers, the meter can calculate the square root of the rate input and display total. Nonlinear analog inputs may be linearized using the custom curve function.

## **WARRANTY**

Otek Corp. warrants its products against defects in materials or workmanship for a period of one year from the date of purchase.

In the event of a defect during the warranty period, the unit should be returned, freight prepaid (and all duties and taxes) by the Buyer, to the authorized Otek distributor where the unit was purchased. The distributor, at its option, will repair or replace the defective unit. The unit will be returned to the buyer with freight charges prepaid by the distributor.

### **LIMITATION OF WARRANTY**

The foregoing warranty shall not apply to defects resulting from:

1. Improper or inadequate maintenance by Buyer.
2. Unauthorized modification or misuse.
3. Operation outside the environmental specifications of the product.
4. Mishandling or abuse.

The warranty set forth above is exclusive and no other warranty, whether written or oral, is expressed or implied. Otek specifically disclaims the implied warranties of merchantability and fitness for a particular purpose.

### **EXCLUSIVE REMEDIES**

The remedies provided herein are Buyer's sole and exclusive remedies. In no event shall Otek be liable for direct, indirect, incidental or consequential damages (including loss of profits) whether based on contract, tort, or any other legal theory.

