

NEW

**3" SHORT DEPTH PROGRAMMABLE
BARGRAPH-CONTROLLER FOR TIGHT SPACES
NUCLEAR, MIL-SPEC OR INDUSTRIAL GRADE**

**MODEL
HI-Q214
(ATB)**

FEATURES:

- Replaces: Chessell's "700," and OTEK'S HI-Q114, but only 3" deep!
- Math Function: +, -, x, ÷, √
- Polynomials: to 9th order
- X-Y table: 25 Points
- Firmware: SV & V Certified: Over 10 years and thousands of units in Nuclear (Class 1E), MIL and Industrial environments
- Environment: MIL-STD 461, 167, 901,810, EPRI 102323
- Automatic Tricolor
- Over 20 input signal conditioners
- Any power input AC or DC
- 4 Relays or 8 O.C.T. (Alarms)
- 4-20mA, 0-5 V analog out
- Serial: 232,485, USB, Ethernet
- Can, Modbus: On request.
- Housing Depth 3"
- Plastic or Metal housing
- Euro Plug-In connectors
- Custom Scale Plates
- Free GUI
- Lifetime Warranty

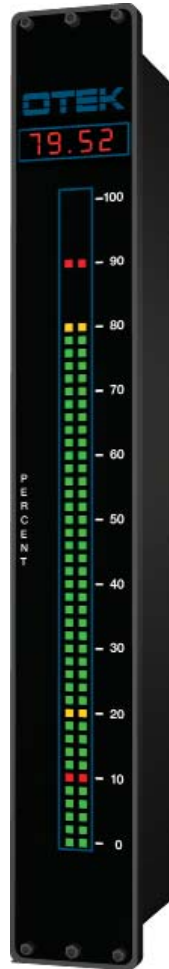

SPECIFICATIONS
(Basic Mainframe @ 25°C)

- A/D: 18 Bit Plus Sign
- Sampling: 16/Second
- Accy. & Resolution: ±0.01%
- Temp. Drift: ± 50 PP/°C
- CMR: > 90 dB
- CMV: ± 2 VDC
- Zero, Span, Averaging, Tare, Linearizer: Configurable
- DAC: 16 Bit:
- Accy. & Linearity: ±0.01%
- Isolation: 500 VDC
- Compliance: Internal (30 V@30mA)
- Relays: 1A SPDT (10A on request)
- O.C.T.: 30 VCE/250mA Sink
- Power: 5-300 VDC, 90-265 VAC (5W max)
- Bargraph: Auto-tricolor, 51. (RGY), 2% Resolution
- Digital: 4 digit (9999), ±0.01% Resolution
- Environmental: See Case Options
- Input Signals: See Signal Conditioners

DESCRIPTION

The new model **HI-Q214** offers the same basic hardware and firmware as the popular HI-Q family bargraphs/controllers, but it is only 3" deep. This makes it ideal for applications where space behind the panel is limited. Both Mil-Std. and EPRI 102323 compliant options are available on request.

OBSOLESCENCE:

The new **HI-Q214** is protected against obsolescence thanks to its 100% modular design. Even the CPU is modular. Our adherence to NUREG -0700 & 0-800 (HMI), EPRI 102323 (EMI/RFI) and several Mil-Std. has made the HI-Q series the controller/monitor of choice in all modern/refurbished installations worldwide.

Actual Size 1.4 "x 11" x 3"

HI-Q COMPARISON CHART

SERIES	HI-Q214	HI-Q114
Relays (4)	1A	10A
DAC	2 Ea.	Up to 2 Ea.
Input Signals	>30	>30
Serial I/O	Any	232,422,485
I/O Isolation	All	DAC & Serial
Diagnostics	Yes	Yes
Depth	3"	8"/12"
Warranty	Lifetime	Lifetime

520-748-7900
FAX: 520-790-2808
E-MAIL: sales@otekcorp.com
<http://www.otekcorp.com>

OTEK™
CORP.
SINCE 1974

4016 E. TENNESSEE ST.
TUCSON, AZ. 85714 U.S.A.

MADE
IN
USA



BENEFITS

OF
THE

HI-Q™

(High I.Q.)

DESCRIPTION: The HI-Q Controllers consist of several products with sub-products. All the products share similar hardware and software with the main difference being their package and display. Once you have familiarized yourself with one, you will know them all! By using common software and hardware, we realize R&D and production savings and we are happy to pass them on to you.

INTERFACE

OPERATOR:

- * **Bargraphs** are used for quick trend indication. The operator can, at a glance, tell where the process is.
- * **Digital Display(s)** are used to give accurate process indication and set point control or calculate values in engineering units. They are also used to display the menu-driven prompts.

PROCESS:

- All HI-Q intelligent controllers offer five methods of controlling your process:
- a) Current: 4-20mA, 1-5mA, 0-20mA (including PID), directly or inversely proportional.
 - b) Voltage: 0-5VDC & 1-5VDC (or 5-0 & 5-1VDC) or any other ranges in between.
 - c) Four (4) or six (6) SPDT 10Amp relays.
 - d) Open collector Bi MOS outputs.
 - e) The serial port (USB, RS232, 422 & 485)

BENEFITS

- * **SV & V:** The HI-Q Series software has been verified & validated as trouble/glitch free per IEEE Std. The hardware has passed several Mil-Std's, such as 461, 462, 617, EPRI 102323 & others. If we don't have it, we'll make it!
- * **Low Cost-High Performance:** When you buy the HI-Q, you buy a "Computing Controller," not just an instrument. Its performance-to-price ratio is unsurpassed in the industry. Only the specific functions that you will need are selected and included; no need for unnecessary extras.

SYSTEM:

- * **Use the Isolated RS Translator** to interface with other industry standard USB, RS-232C/RS-422 or RS-485 devices with open or proprietary protocols. If they are "RS" and "ASCII" compatible, the HI-Q can communicate with them.
- * **Stand Alone: as Single or Multi Loop Controller** Whether under the protection of a factory environment or in the open field, the HI-Q will meet and exceed your expectations.

CONFIGURATION: Just Upload OTEK's **FREE Windows Navigator™ (GUI)** and configure or re-configure your HI-Q without an instruction manual in minutes!

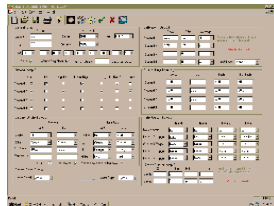

COMMON FEATURES

- * **Ready to Use:** Just apply power, select the commands, set your limits and start controlling.
- * **Automatic Tricolor:** Changes colors (Red, Blue, Purple, Green, Amber) upon reaching a limit. **Flashing & dimming** of the displays are under your control.
- * **Password Security:** You can enable or disable the front panel keypad (Optional Keypad).
- * **Emergency Shut Down:** Any three keys held down simultaneously will shut down the controller sending all outputs to a "Fail Safe"(Off) state.
- * **Power on Test (POT):** Will test every major section of its hardware, software and firmware and flag any malfunctions.
- * **C.O.P. (Computer Operating Properly):** Checks the operation of its internal algorithms. You can disable it.
- * **Mathematical Functions:** Insert the math function. Transmit and/or control with the result.
- * **Polynomials and Look Up Tables:** Make your own or use the preprogrammed polynomials to 9th order.
- * **SelfDiagnostics:** The HI-Q will detect major software/hardware failure & warn you via its display/serial port.
- * **Modular Design For Long Life Expectancy**
- * **Lifetime Warranted**
- * **Obsolescence Proof:** All critical components have 2nd source and/or are in modules, so they can be replaced/redesigned efficiently and economically.
- * **Customs:** Very economical and efficient, thanks to its modular design.

Some Commands You Can Enter Via the Optional Keypad (More Via the Serial Port) or GUI

- Security-Code-Restricted Access
- Zero Offset/Tare
- Full-Scale Range
- Colors (LED or LCD backlight) (Any available mix)
- Intensity: None to Max.
- Blinking On/Off
- Filtering (averaging)
- Danger Alarms(Warning/Stop)
- Relays (4 or 6), Bi Mos (8) On-Off
- Current Loops 4-20mA(0-5V out)

1 → 3	Assign any Channel to any
4 → 2	Display & Relays to Channels or External Commands
A/M	* Auto/Manual Process Control
K	Assign any Constant to any Channel
Δt	Assign any Delay to any Output
P	Proportional
I	Integral
D	Derivative
	Your Own Custom Commands
oops!	Reset to Default Parameters
Poly	Ours or Your Polynomials/Tables
...!!	* Process Predictability (Signal(s) vs Time (Contact Otek)

- +, -, x, ÷, √, Σ Selectable
- Alarm w/or w/out Delay
- Watchdog Timer
- COP& Self-Diagnostics
- Store any Non-Volatile Command in Memory
- Any Address Alphanumeric
- Any speed 1.2 to 19.2 KBPs
- Any Resolution (down to 1=50,000)

THE **BENEFITS OF THE "HI-Q"** (Continued)

Now you can monitor and control your process from the comfort of your control room or at the site with an inexpensive PC & OTEK's complete line of **Programmable Intelligent Controllers**. Use them either as a standalone unit or as part of your DCS or SCADA system.

CONFIGURATION with OTEK's New **Windows Navigator™** (PC G.U.I.) is so fast & easy that no instruction manual (other than for connections) is required! Just Plug in your PC terminal, upload our **FREE** program and start selecting your configuration. Within minutes, you will be done, and you can even email it to remote locations!

For a **FREE** copy of the Windows Navigator™, visit our website at www.otekcorp.com and click on Windows Navigator™.

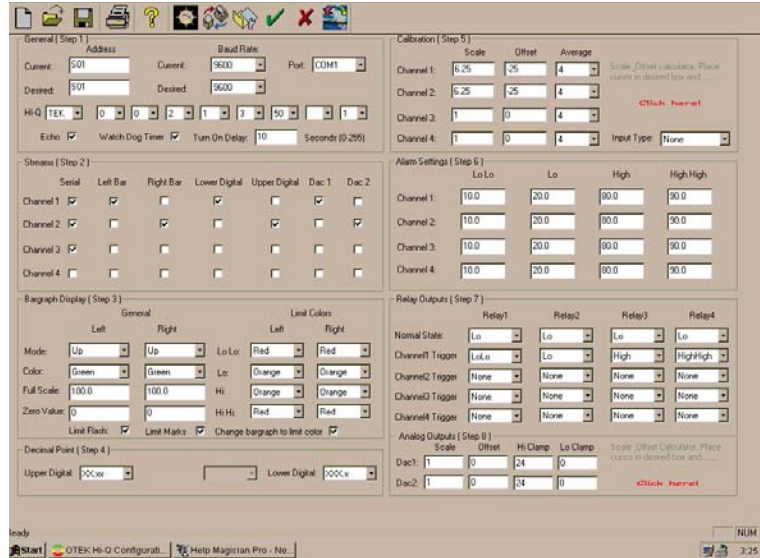

OTEK's "HI-Q" line of **Programmable Intelligent Controllers** with their built-in and isolated signal conditioners will connect directly to your sensor and/or transducer and even power it. All you have to do is to connect & power up. We will even preprogram the "HI-Q" for you if so desired for **"Plug-N-Play."**

Common Features of the "HI-Q™" Series:

- Math Functions: +, -, x, ÷, √ and More
- Isolated 18-bit A/D w/Signal Conditioners
- Isolated Analog Outputs (4-20mA & 0-5VDC)
- (4 or 6 each) 10A SPDT Relays for On-Off Control
- O.C.T. (250mADC) for Fast On-Off Control
- Isolated 5 & 10-32VDC (24VAC Also) Power Input
- Isolated 90-265VAC or (100-350VDC on Request) Power Input
- 5 VDC Power for Low Voltage Applications
- Look Up Tables for Thermocouples/RTDs
- Polynomials to the 9th Order
- Customer's X-Y (25 Point) Tables
- ZERO • TARE • SPAN • AVERAGE
- All ASCII Characters for Open Protocol
- Programmable Baud Rate & Address
- Isolated RS-232C/422/485 Translator & USB (Ethernet on Request)
- Automatic Tricolor LED Displays with Dimming, Blinking & Pointers
- P.I.D. or Just Plain Proportional Control
- SV & V, Mil-Stds with Self-Diagnostic Capabilities
- Modular Design for Long Life Expectancy
- Lifetime Warranted

What Can the "HI-Q" Series Do for You?

It can accurately and reliably monitor and/or control your process as a standalone unit or as part of a DCS/SCADA for complete factory automation.

From the most basic form as a serial input **remote display** to the most complex as stand alone **Programmable Intelligent Controller**, the "HI-Q" Series will perform to specifications in the oceans, on earth or in outer space, in the Alaskan tundras or in the Tucson deserts.

MILITARY, NUCLEAR, SEISMIC & EPRI TR-102323R3 models are (or being) approved. Contact
OTEK™

Where Are the "HI-Qs" Being Used?

Only OTEK's HI-Q Series are in outer space (**Mir & I.S.S.**), military aircraft (**night vision**), naval warships (**Mil-Spec**), nuclear power plants, offshore exploration/drilling, mass transit (**Metro**), biomedical (non-life support), pharmaceutical, agricultural, waste & water treatment, etc.

IS YOUR APPLICATION MORE CRITICAL?

HI-Q214 continued

SERIAL I/O (DIGIT 2): 500 V isolated from other I/O.

Options 0: RS232: 1200-19.2kb, all ASCII (8N1) open protocol DB9.

Options 1 & 2: RS232 to RS485 or RS422 translators. They convert one to the other automatically and communicate with your **HI-Q214**. Same as options 0 & 3, with DB9 connector.

Option 3: RS485: 1200-19.2kb, all ASCII (8N1) open protocol DB9 connector. Add terminating resistor (~300 Ohm) at 1st and last only.

Option 4: USB: 1200-19.2kb, all ASCII (8N1) open protocol "USB Type B."

Any terminal program (Hyperterminal, Procomm, Kermit) will work with OTEK's serial com. ports. For USB download our Driver at www.otekcorp.com.

FIG. 214-8 TYPICAL CONNECTIONS

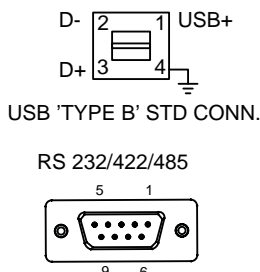

1: N.C.; 2: TXD; 3: RXD; 4: N.C.
5: GRND; 6: TXB; 7: TXA; 8: RXB
9: RXA. (PINS 6-9 FOR 422; PINS 7 & 9 FOR 485).

Option 6: Ethernet: 10 Base T, RJ45. Meet present standards to 19.2 KB. Free Driver and GUI.

POWER INPUT (DIGIT 3):

Options 0 & 4: Non-Isolated 5 or 6-32 VDC Power: See Specific Option # & Connections.

All listed I/O options are available. Power requirements vary with options included. The **HI-Q214** with No Control and Power Out (Digit 5 & 6, Option 0) requires under 1W (200mA@5VDC) per channel (bargraph). Range is ±5%

Options 1-3: Isolated Power

These options offer minimum isolation of 500 VAC or DC and their efficiency is about 80%. Again, add all the options: power x 1.2 to arrive at total power required.

FIG. 214-7 POWER INPUT

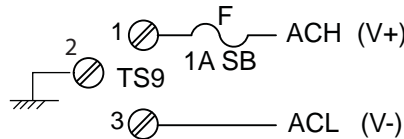

NOTES:
MAX. 50mA OUT FROM 5V & 30 mA

CONTROL OUTPUTS (DIGIT 5):

Option 1: SPDT Relays (4):

Contacts are rated at 1 amp at 120 VAC/30 VDC resistive load. Power required by each relay is 200 mW (40mA@5VDC) x 4=800 mW. (Contact OTEK for 10 A contacts). 300V varsitors included.

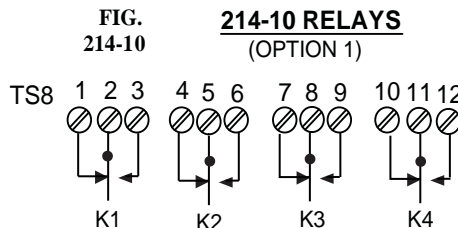

Option 2: 8 Open Collector Transistors (O.C.T):

Four O.C.T are included and all are common emitter (sinking) to digital ground (terminal TS8-10). The 5 VDC internal powers is available at terminal TS8-12. Maximum current allowed per O.C.T. (From the internal 5 VDC) is 20mA/O.C.T. If external VCC is used, the maximum V_{CE} is 30 VDC and 100 mA per O.C.T. Switching time is under one (1) µSecond.

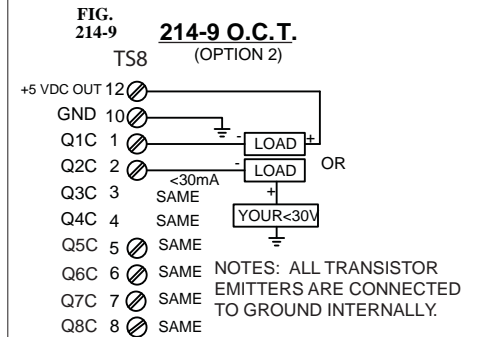

ANALOG & POWER OUTPUT (Digit 5):

Option 1-7: Isolated 4-20 mA:

This option is offset & scaled via the serial port (digit 2) and can be configured for 4-20 (Option 1), 0-20 or 0-24 mA or 0-5 VDC (Option 2) via internal jumpers (standard is 4-20 mA). This option requires under 200 mA@5VDC (1 W) internal power due to step up from 5-30 VDC compliance. Accuracy & linearity is +/- .1% of setting and can drive up to 1K ohms load. For 4-20mA or 10K for 0-5 VDC)

FIG. 214-11 ISOLATED 4-20mA

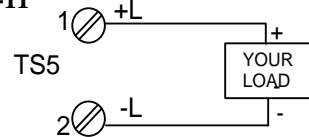

HI-Q214 continued

Options 6-8 and A & B: Isolated 30 VDC Compliance (Digit 5)

You can use it to excite your transmitter at up to 25mA. It consumes under one (1) Watt at full load.

Option 8, A & B have only the isolated 30V DC out so you can power your transmitters with either 15 V or 30 V. Max current out is 25mA on each.

FIG. 214-12 **ISOLATED 30VDC OUT**

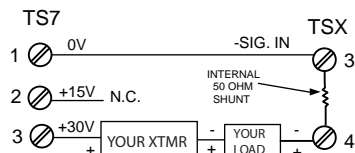

NOTE: TS1 THRU 3 DEPENDS ON CHANNEL YOU USE.
TSX=TS1, TS2 OR TS3

SIGNAL CONDITIONERS (DIGITS 6 & 7)

The **HI-Q214** offers > 30 input signal conditioners that accept inputs directly from your transducer. If not listed, contact Otek. If we don't have it, we'll make it.

Option 00: Serial Input Remote Display/Controller: Here you can use the **HI-Q214** as a remote display/controller with modified (STD.) ASCII to alpha-numeric display for DCS SCADA, PLC systems. Note: Serial input options 0-6 on Digit 2 must be ordered.

Option 09: Custom: Use this option to describe any custom input, such as TTL/CMOS command inputs to the CPU, and contact us for feasibility and cost. Two TTL compatible interrupts are included at TS4-1 & 2, with ground at SS4-3. These are available on all input options 00-59.

Options 10, 30 & 50: VDC:

Input impedance is 1 mega Ohm on all VDC ranges.

Accuracy: $\pm 0.05\%$ of F.S.

FIG. 214-04 **HI-Q214 DC & AC INPUT SIGNALS**
(OPTIONS 10-15, 24-28, 30-35, 44-48, 50-55 & 64-68)

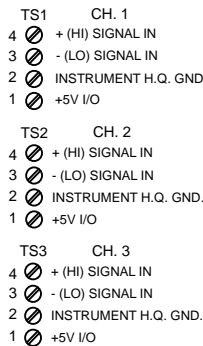

NOTE: ALL INPUT SIGNAL OPTION CONNECTIONS, CH1=CH2=CH3, UNLESS OTHERWISE NOTED.

Why 3 Analog Inputs For 1 or 2 Displays?

Many of our customers use math functions such as CH1+CH2=Display; CH1-CH2 xCH3=Display

Options 11, 31 & 51: 1mADC:

Since the **HI-Q214** is 500mV full scale (10,000 Counts) the "Shunt" resistor used is 500 Ohm. Don't forget that maximum display is 9,999 not 10,000! Use option 29 or 49 for other ranges and specify. Connections per Option 10.

Accuracy & Linearity: $\pm 0.05\%$ of F.S.

Option 12, 32 & 52: 4-20mA: It only drops 0.5V (burden) @ 20mA (25 Ohms). The "**HI-Q214**" needs ~2W/Bar plus other options to operate. Connections per option 10.

Accuracy & Linearity: $\pm 0.05\%$ of F.S.

Options 14, 15, 34, 35, 54 & 55:

V & mA RMS: Here we use a **True RMS-DC** Converter for accurate ($\pm 0.05\%$) measurement of sine waves up to 10KHz ($\pm 0.1\%$ for 10-20KHz) and SCRs fired to $\pm 1\%$. Input impedances vs. range are the same as for VDC & mADC ranges. Use #29 or # 49 for other ranges and specify.

Connections: Per option 10.

Accuracy & Linearity: $\pm 0.1\%$ of F. S.

Options 17, 37 & 57: Strain-Gage (<1000 Ohm Type):

Here we use high accuracy and stability constant current (~1mA) source, and a differential amplifier to convert the 2 or 3mV/V (typical) sensitivity of your "Loadcell". *Specify* your Strain-Gage sensitivity and full scale and the **HI-Q214's** display at Zero and Full Scale Please! For dual input, use #49 and specify.

Connections: CH. 1: TS1=CH.2: TS2=CH.3: TS3.

Accuracy: $\pm 0.05\%$ of F.S.

FIG. 214-24 **HI-Q214 S - G INPUT SIGNALS**

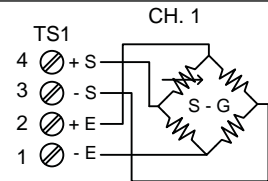

HI-Q214 continued

Options 18, 38 & 58: Strain-Gage

($\geq 1K < 4K$ Ohm): These are typically "Monolithic" **S-G** that require constant voltage (preferably) excitation. We use 4.096V for high stability and accuracy. **Specify** your S-G impedance and sensitivity and the **HI-Q214's** display at Zero and Full Scale.

Connections: Same as option 17.

Accuracy: $\pm 0.1\%$ of F.S.

Note on S-G: Some S-G offer +/-1VDC or 4-20mA conditioned output. Use Option 9 and specify.

Option 21,41 & 61: RTD

(PT100): We excite your 2-, 3- or 4-wire RTD with 200 μ A to avoid the "self heating" effect. The range of the **HI-Q214** is the same as your **RTD** typically -200°C to +800°C (-328 + 1562°F). You can place the decimal point at will (typically -200.0 to 800.0 (-328.0 to 1562.0)). The **PT100** has a temperature coefficient of 0.00385 Ohms/Ohm/°C. (For legacy 0.00392 TC {known as ANSI 392} contact **OTTEK** and use Option "09".)

Note: You can change °C, °F and RTD type (PT100, PT1000, ANSI) via serial port.

Connections: Same for CH1=CH2=CH3; CH1 at TS1; CH2 at TS2; CH3 at TS3.

Accuracy: $\pm 0.5\%$ of F/C plus sensor's error.

Note: For 2 wire, jump - S to -E and +S to +E. For 3 wire only jump -S to -E.

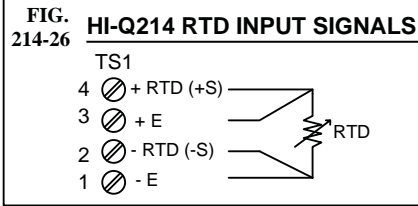

Option 22, 42 & 62: Thermocouple (Any Type): This **TC** has a range of -210 to + 760°C (-350 + 1390°F). Its color is white (+) and red (-), cold junction (CJ) is inside the **HI-Q214** at the connector base. Make sure the connections from the **HI-Q214** and your **TC** are as close to the **HI-Q214's** entrance as possible to avoid errors. If you short out the **HI-Q214's** +**TC** & -**TC** together, the **HI-Q214** will read the ambient temperature due to its built-in C.J.C.

Note: You can change °C to F to °K and TC type (any published type) via serial port.

Connections: For CH. 1=CH.2=CH. 3; CH. 1 at TS1; CH.2 at TS2; CH. 3 at TS3.

Accuracy: $\pm 1^0$ F/C of signal input.

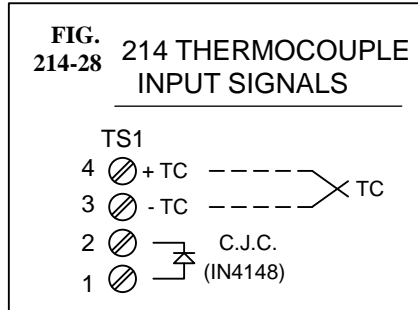

Options 24, 26, 44, 46, 64 & 66: Frequency Input:

We use an **F-V** to accept frequencies from 40 - 20KHz and amplitudes from 1-400V peak or dry contact or open collector transistor (O.C.T.). For 50 to 440 Hz power line frequency measurement, use Option #24, 44 or 64.

Connections: For CH. 1=CH.2=CH. 3; CH. 1 at TS1; CH.2 at TS2; CH. 3 at TS3.

Accuracy: $\pm 0.05\%$ of F.S.

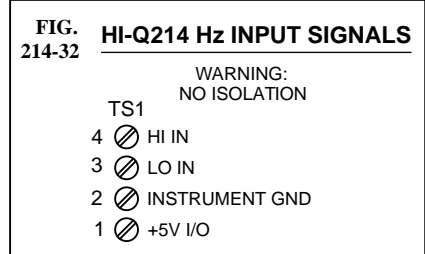

Option 27, 47 & 67: pH (Acidity): We use a FET input (10^{15}) amplifier and calibrate the **HI-Q214** for 0-14.00 pH using the Industry's standard ± 413 mV = ± 7 pH co-efficient.

Note: Not temperature compensated.

Connections: For CH. 1=CH.2=CH. 3; CH. 1 at TS1; CH.2 at TS2; CH. 3 at TS3.

Accuracy: $\pm 0.05\%$ of F.S.

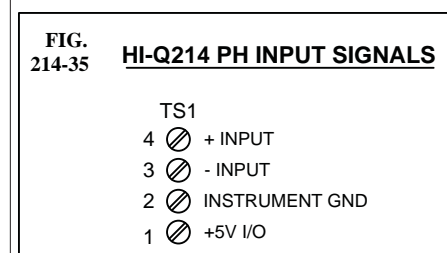

HI-Q214 continued

Option 28, 48 & 68: ORP (Oxygen Reduction Potential): Our FET amplifier (10⁹) accepts the industry standard 2000mV F.S. of the probe and the **HI-Q214** displays it in % (0-100.00%).

Connections: For CH.
1=CH.2=CH. 3; CH. 1 at TS1;
CH.2 at TS2; CH. 3 at TS3

Accuracy: ±0.05% of F.S.

FIG. 214-35	HI-Q214 PH INPUT SIGNALS
	TS1
4	⊗ + INPUT
3	⊗ - INPUT
2	⊗ INSTRUMENT GND
1	⊗ +5V I/O

OTHER OPTIONS NOT LISTED:

1. % RH, Specify your sensor.
2. Very Hi Speed Track & Hold to >50 K Hz.
3. Triple redundancy.
4. Logarithmic/Anti-Logarithmic
5. To your specifications.
6. Events/Time-Count.
7. Flow/Volume-Speed/Distance.

CASE TYPE (DIGIT 8):

Option 0, Plastic: ABS 94VO black is standard. All options have 2-piece plug-in screw-terminal connectors and seismic-tested mounting tabs (2).

Option 1, Metal: Aluminum-machined, nickel plated (ready for EMI/RFI compliance), black powder coated.

Option 9, Custom: Use this to specify your needs. M, N or E options (digit 10), automatically get metal housings.

GRADE (Digit 9): For Industrial use Option I. For M specify Mil-Std. to comply (i.e. 461, 167, 901, 810, etc. For N & E (EPRI) contact Otek.

SCALE PLATE (Digit 10): Specify your custom requirement by using #9. Option 0 is standard 0-100%.

RANGE & CALIBRATION

(Digit 11): Option 0: IS 0-100% for bar and per input option range 0-FS=0-1000 counts. Use #9 and specify your needs.

Note on NOA & Class 1E:

Otek's successful **HIQ Series** has been 100% **SV & V** and seismic tested and certified for **Class 1E** by 10CFR50 qualifier (s). Thousands of units are in service since the 1990's. The **HI-Q214** represents the 2nd generation and replaces the HIQ114 F.F.F. by only 3" deep.

Note on MIL-STD Versions: The new **HI-Q214** is a fraction of the size of its predecessor-the **HI-Q114**, and lends itself to a more economical solution for any MIL-STD qualification.

HI-Q214 MECHANICALS AND TYPICAL CONNECTIONS

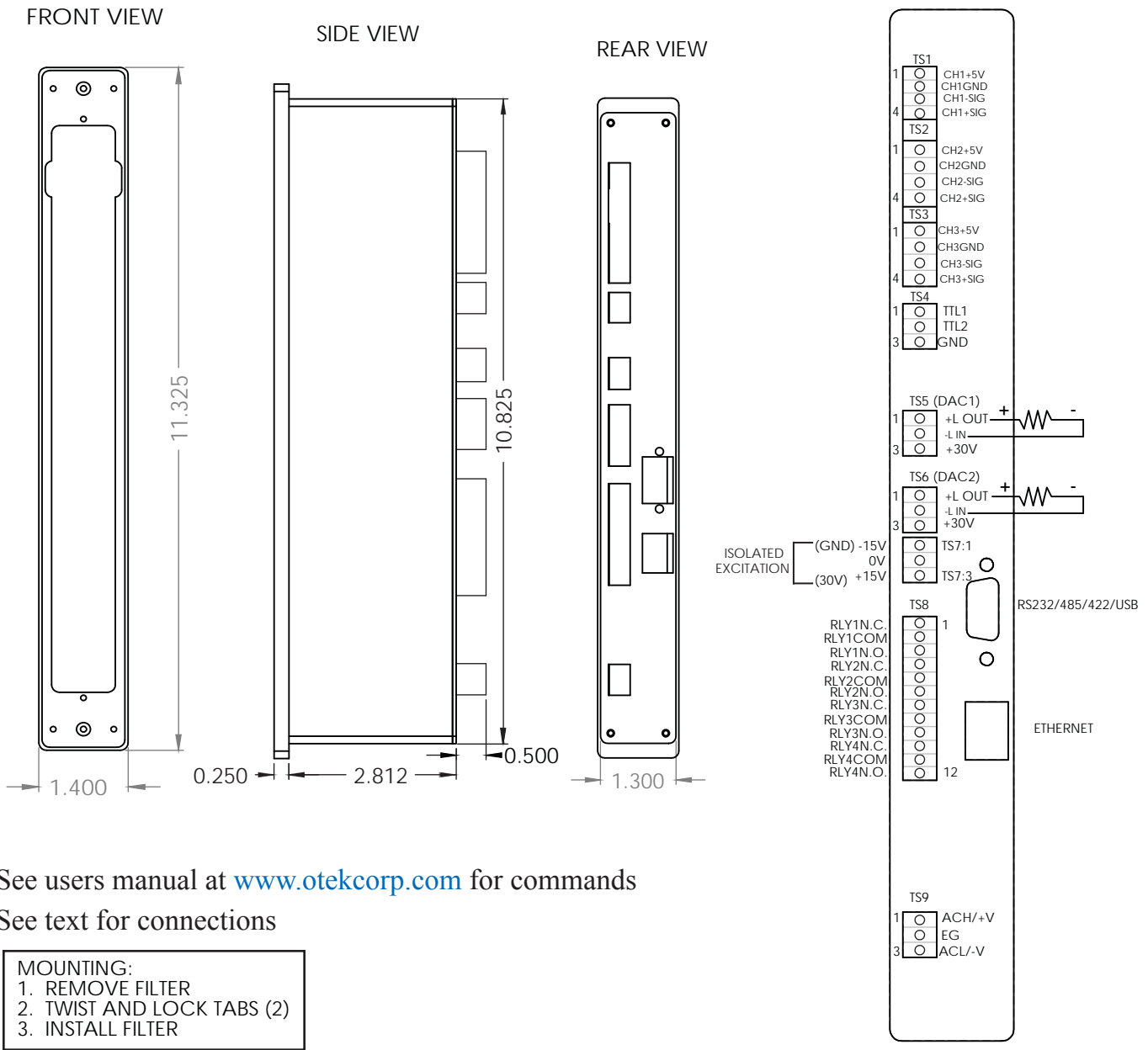

-See users manual at www.otekcorp.com for commands
 -See text for connections

- MOUNTING:**
1. REMOVE FILTER
 2. TWIST AND LOCK TABS (2)
 3. INSTALL FILTER

- NOTES:**
1. ALL DIMENSIONS ARE IN INCHES (±0.010)
 2. PANEL CUT-OUT: 10.88X1.38
 3. MAX. PANEL THICKNESS: 0.19

HI-Q214 continued

Functional Overview

A block diagram of the HI-Q is shown in Figure 1. Analog, discrete, and high voltage inputs are measured, conditioned, isolated, and sent to the CPU for processing. Serial communications, 4-20mA outputs and 0-5Vdc outputs are all isolated. The CPU handles all data processing, engineering conversions, linearization, and alarms. The display-updating is handled by a second microprocessor.

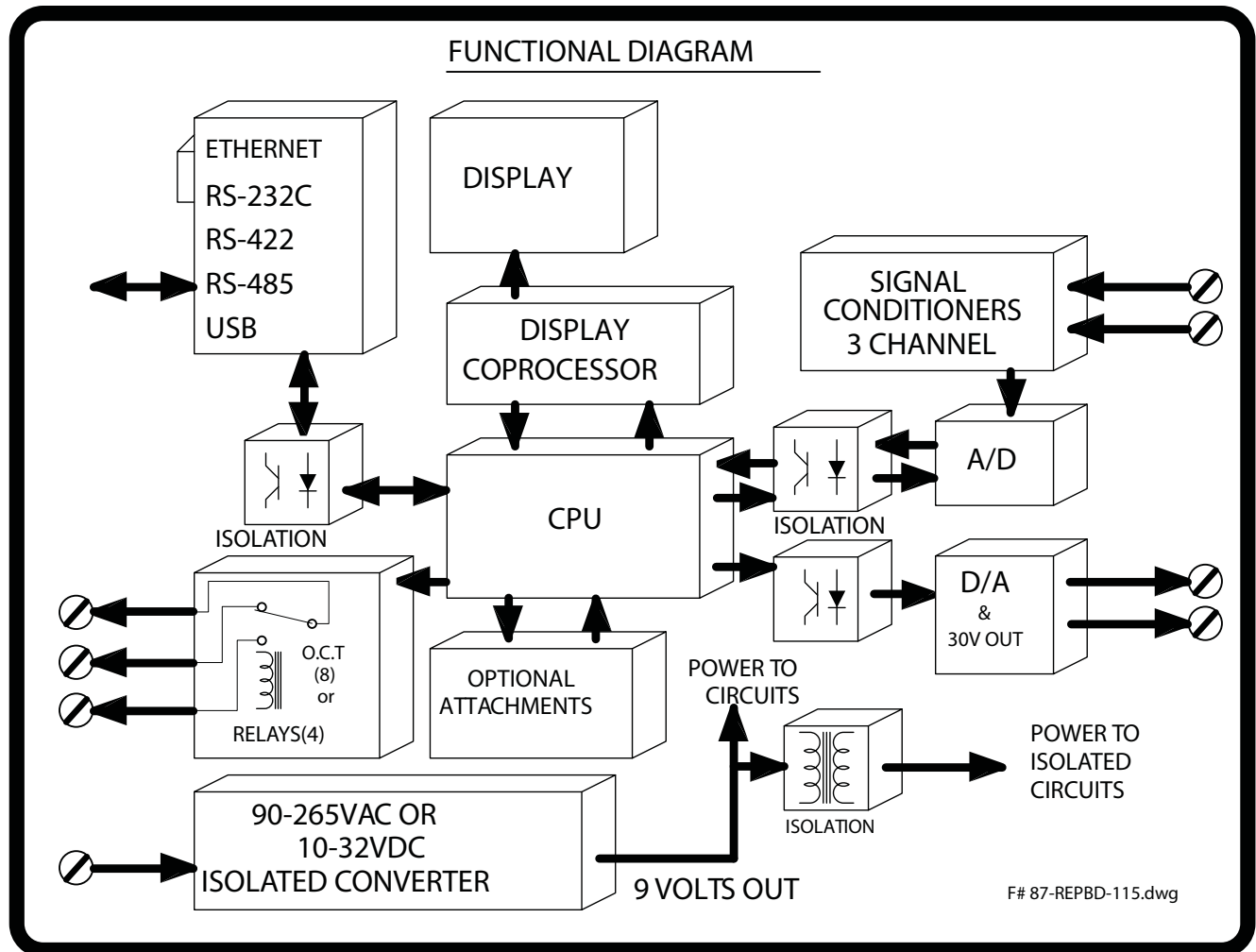

**MODEL
HI-Q214**

NOTE: Please READ BEFORE building part number:

1. If digit 9 is option E, Digit 8 must be option E.
2. See notes at bottom of page.

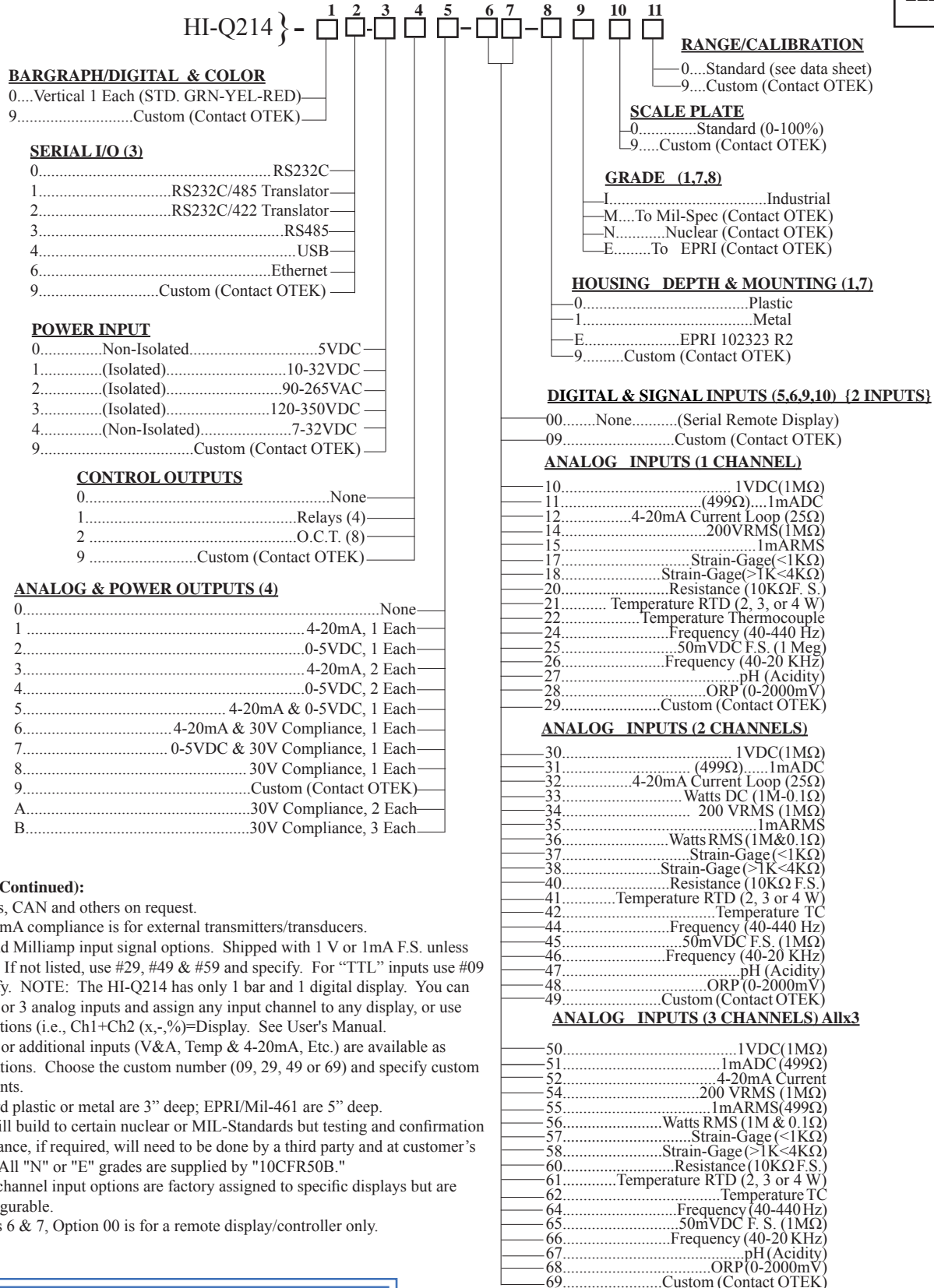

NOTES (Continued):

3. Modbus, CAN and others on request.
4. 30V/30mA compliance is for external transmitters/transducers.
5. Volt and Milliamp input signal options. Shipped with 1 V or 1mA F.S. unless specified. If not listed, use #29, #49 & #59 and specify. For "TTL" inputs use #09 and specify. NOTE: The HI-Q214 has only 1 bar and 1 digital display. You can order 1, 2 or 3 analog inputs and assign any input channel to any display, or use math functions (i.e., Ch1+Ch2 (x, %,)=Display. See User's Manual.
6. Mixed or additional inputs (V&A, Temp & 4-20mA, Etc.) are available as customizations. Choose the custom number (09, 29, 49 or 69) and specify custom requirements.
7. Standard plastic or metal are 3" deep; EPRI/Mil-461 are 5" deep.
8. Otek will build to certain nuclear or MIL-Standards but testing and confirmation of compliance, if required, will need to be done by a third party and at customer's expense. All "N" or "E" grades are supplied by "10CFR50B."
9. Multi-channel input options are factory assigned to specific displays but are field configurable.
10. Digits 6 & 7, Option 00 is for a remote display/controller only.

DOWNLOADS: For manuals, user-software or drivers:
www.otekcorp.com