

**NEW**

# NEW TECHNOLOGY™ METER

**NTM-5  
Pat. Pend.**

## Current Loop, Signal or External Powered

Replaces: Any 3" x 6" Barmeter

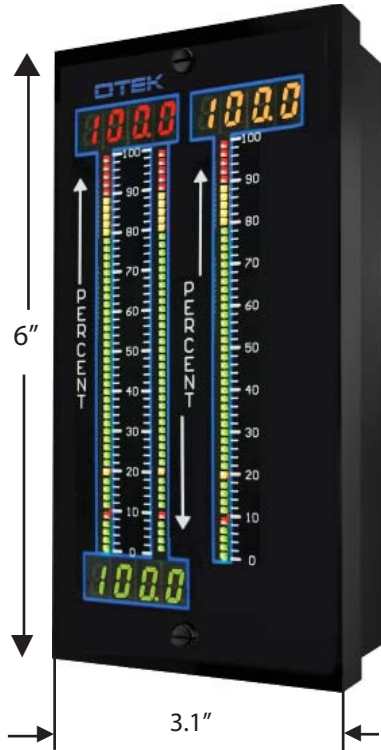

Panel Cutout 3" x 5.6"

### FEATURES:

- \*Automatic Tricolor Bar with Intensity Control
- \*4 Digits at 0.3" (9.9.9.9 or -1.9.9.9)
- \* r n P t F R i L Alarm with Run Time Stamp
- \*Self Diagnostics
- \*Isolated Serial I/O
- \*USB/RS485
- \*Configurable Bar Direction (Up/Down/Center Zero)/Pointer
- \*Only 100mW@5VDC!
- \*Intensity Control
- \* Math functions (+, -, x, √, ÷, X-Y tables, polynomials)
- \*Averaging: None to 255
- \*Addressable: 8 Characters
- \* Many Power Input Options
- (External Powered Models Only)**
- \* >30 Isolated Input Signals
- \*4 Relays or O.C.T. (Open Collector Transistors)
- \*4-20mA/30V Output
- \*Ethernet
- \*μSD Flash Memory: 32 GB
- \*Lifetime Warranty

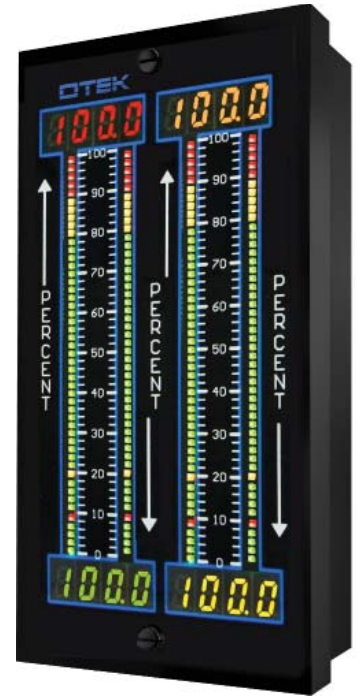

1, 2, 3 or 4 Channels

**DESCRIPTION:** The New Technology Meter (NTM) series combines over 40 years of experience with the latest ASIC uC and ultra-efficient multicolor LED technology to bring you into the 21st century. The NTM external power series features over 30 signal conditioners (1" square) which are housed in many industry's standard packages to replace form, fit and function any analog or digital panel meter. If not, we'll make it!

Our patented hardware and firmware gives you the highest reliability (we have a lifetime warranty) at the lowest cost, with features such as: automatic (programmable) tricolor bargraph (like a traffic light); automatic signal fail detect (open or short); indication and serial transmission with run time stamp and units ID, isolated retransmission (4-20mA), and universal power inputs (5-32VDC or 90-265VAC). The NTM Series offers several math functions such as X-Y tables, polynomials and log-anti-log functions.

The NTM signal and external power series also feature isolated USB, RS485 or ethernet, open collector transistors (4/channel) and SPDT relays (4/channel). You can tell us your custom needs and we'll make it (or might already have it)!

The NTM-5 is available in either a loop (4-20mA), A.C. signal or external power version. The external powered versions can accommodate 4 relays, isolated DAC and power for the analog output (per channel), include >30 signal conditioners and isolated input power options, as well as ethernet and flash memory (μSD). Standard factory set color changes are: red: <10, >90%, yellow: <20, >80%, green: >20, <80% of F.S. Use digit 14, option 9 for custom configuration (you can change it with simple commands).

**NOW 10CFR50 APP. B & 10CFR21  
& NEI 08-09 (Cyber Security)  
Compliant**

- \*Buy Direct From OTEK
- \*Free N.R.E. For Customs (Rules Apply)

520-748-7900  
FAX: 520-790-2808  
E-MAIL:sales@otekcorp.com  
http://www.otekcorp.com

**OTEK™**  
CORP.  
SINCE 1974

4016 E. TENNESSEE ST.  
TUCSON, AZ. 85714 U.S.A.

MADE  
IN  
USA



# THE PRODUCTS

All New Technology products share the same innovative electronic circuit design. The difference between the models is their mechanical features (see Block Diagram and mechanical drawings). Some are displays only, some are single or multi channel, some can have relays, DACs, ethernet and flash memory, and some require an external power source. But all products contain the New Technology, which consumes less than 1% of comparable digitals (20-100mW for loop/signal powered versions) and approaches the power consumption of analog meters.

## WHAT CAN YOU DO WITH OTEK'S NEW TECHNOLOGY?

**Note on Otek's Powerless™ Technology:** If your signal cannot supply  $\geq 15\text{mW}$  ( $\sim 5\text{V}/3\text{mA}$ ), contact us or use external power models.

**1. One Channel Models: -0, -4, -B, -D, -F, -H, -L, -M, -N, -P, -S & -X:** Implement any math function, X-Y table (25 point), polynomials (9<sup>th</sup> order), offset, tare, zero, scale, log & anti-logarithmic to affect the unit's display at will. Some examples are: change the display & data using any combination as commanded by your algorithm, such as  $+/-/X/\div/\sqrt{\quad}$  or set a variable or linearize the display using X-Y tables or polynomials. This works well for odd shape containers. You can also change the reading from °F to °C or °K or compress/expand the display (and data out) using the log and antilog functions. In addition, you can change the factory default alarm pointers and colors or delete them. Zero & Span potentiometers **are included** for manual adjustment.

**Note:** Models -D and -F have internal USB serial I/O that is not accessible to the customer. Contact Otek for access

**OTEK's New Technology** series is only limited by your needs and imagination. Just give us a call at 520-748-7900 or email us at sales@otekcorp.com and give us the challenge to develop the best algorithm for your process.

**2. Two Channel Models: -1, -2, -3 and -5 through -9 & -A: Note:** Also available in models with 3 or 4 channels. Features include all those of the single channel models and each channel is 100% isolated from each other. In addition, you can add, subtract, multiply, divide, find the square root between channels. You can also use one channel to monitor/control the input signal and the second channel to indicate deviation, differential such as PID, alarm override or one channel setpoint can be used to control another channel function. You can also use one channel as a backup if the other channel becomes disabled or use them as volume & flow ( $\sqrt{\quad}$ ) monitors/controllers. The **New Technology** two channel models are also perfect as REM/RAD indicators/controllers (also see our RPM series with log-antilog functions for radiation monitoring).

Contact OTEK for algorithms and formulas or any idea you wish to share with our audiences via our Youtube or Facebook page posts.

**3. Three Channel Models: -3, -5, -7, -8 and -A: Note:** Also available on 4 channel models -5, -7 & -8. Otek's New Technology three channel models perform all the functions outlined in #1 and #2. Further, one channel can indicate the input variable and the other two channels can be setpoint indicators/controllers (Hi, Hi-Hi, Low and Low-Low limits), or subject the input/output to any mathematical function or algorithm such as **PID** or display the input vs. output and derivative, or switch scales when the input reaches a limit/band such as for flow-volume-pressure or temperature. Monitor Volts, Amps and Watts AC or DC or any of 3 variables, including Hertz, lead/lag, power factor, peak/valley or for synchronizing of power lines with the bipolar (center zero) tricolor bargraph.

The **New Technology** series brings **Process Automation Control (PAC)** within your reach and affordability. These models are compatible with any DCS/SCADA system using their USB/RS485/Ethernet I/O options and allow for ease of interface with wireless systems.

**4. Four Channel Models: -5, -7 and -8:** The four channel models offer all of the functions outlined in #1, #2 and #3. However, with the additional channel available, the New Technology barmeters rival flatscreens with superior HMI/MMI functionality and ease of viewing/analysis of any combination of 4 variables. For example, Volts/Amps/Watts/Hertz or temperature/pressure/pH/humidity. The four channel models can also be used to monitor/control the product of the other 3 variables, making them ideal for the petrochemical industry.

**Data Logging?** Some models offer optional  $\mu\text{SD}$  memory to record 24/7 anything available via the serial I/O. Maximum capacity (and growing) is 32 GB!

### REDUNDANT CONTROL:

Because all channels are 100% isolated from each other, you can use any multi-channels model as a redundant controller. If you need the "Democratic vote," algorithm, contact OTEK or see our Model **TRC** (Triple Redundant Controller).



**Digit 5, Serial I/O & Memory:**

**Settings:** 8N1N, 1200-19,200 Baud, ASCII.

**LOOP/SIGNAL POWER ONLY**

**Digit 5, Serial I/O: Option 0, USB:** Complies 100% with V2.0 and if digit 10, option 1 is selected (USB powered) then digit 5 must be option 0.

**Digit 5, Option 1, RS485:** Complies with industry standard and requires 5VDC@<3mA and a terminating 330 Ohm resistor at first and last unit in the BUS.

**EXTERNAL POWER ONLY:**

**Option 0, USB & Option 1, RS485** (see above), plus:

**Digit 5, Option 2 Ethernet:** Complies with 10 Base-T/100Base-TX RJ45 up to 19,200 Baud. Maximum power consumption is <300mA@5V (1.5W).

**Digit 5, Options 3 & 4: uSD Flash Memory: Contact Otek for availability.** Internal  $\mu$ SD flash memory with up to 32 gigabytes capacity. You can store selected data at-will via serial command and download it as required. A 32GB card logging 3 times per second can hold approximately 4 year's worth of data.

Need a Transmitter?  
See model NTY

**DIGIT 6, GRADE:**

Industrial Grade (Options 0 or I) is per these published specifications. Grades **M** and **E** per agreed specifications. Options **E** & **M** typically include an EMI/RFI shield all around and filtered connectors to meet EPRI-TR-102323-R3 (requiring ~2" deeper case). OTEK will build to certain nuclear or MIL-Standards but testing and confirmation of compliance, if required, will be quoted extra. Option 0 is 94VO plastic, option "I" is an aluminium nickel plated case and cover; bezel face has black powder coat finish to Mil-Specs. The back cover is either black plastic or nickel plated aluminum. Typical Mil-Specs: 461, 462, 169, 901, 801, RTCA-160, I EEE344, etc. Contact Otek for custom colors.

**NTM-X:** Certified for Class I, Div. 1, Groups B-G; EX & IECex: IM2, Exd1.

**Other Important Data:**

**Math Functions:** +, -, x,  $\div$ ,  $\sqrt{\quad}$ , Polynomials to 9th order, 25 Point X-Y table, zero, offset, span and tare. You can add, subtract, multiply, divide (etc.) one channel to/from another channel and display the result in the other channel (i.e.  $V(\text{Ch.1}) \times A(\text{Ch.2}) = W(\text{Ch.3})$ ).

**Signal Failure Alarm:** Requires approximately 1 minute of normal (mid-scale) operation for it to alarm the display and output the serial data after the signal (Powerless™) has ceased.

Serial I/O: Setting: 8N1N, 1200-19,200 BAUD, 8 Character Address

**PID:** Programmable (best with >dual channel models) automatic or manual with external 10K Ohm potentiometer (option 56).

**High Quality:** No matter their size or number of channels all use the same (SV & V) firmware, hardware and commands. No matter their grade (Industrial, Mil-Spec, Nuclear) they all carry a **lifetime warranty**

### Industrial Grade Common Electrical Specifications

**Input & Display:**

- \*A/D: Accuracy, Linearity & Resolution:  $\pm 0.5\%$  of F.S.  $\pm 1$  L.S.D. over entire temperature range of 0-60° C.
  - 12 Bits, Conversion Rate: 40/sec, Averaging: 0-255, zero, span, offset, tare, math functions, 25 point X-Y tables & polynomials (9<sup>th</sup>)
  - \*Bargraph: 51 Automatic Tricolor (R/Y/G) Segments
  - \*Digits: Four Full Digits (9.9.9.9 & -1.9.9.9).
  - \*Typical Power Consumption of Display: 10-100mW@3.3V-5V
  - \*Temperature Coefficient:  $\pm 50$ PPM/°C
  - \*Operating Temperature: -10 to +60; Storage: -20 to +70°C
  - \*CCMR: >90dB@50-60Hz
  - \*Isolation: >500VDC to any other I/O & P.S.
  - \*Humidity: 5-95% RH non-condensing
  - \*Front Panel: NEMA 3. NEMA 4x on request.
  - \*Failed Signal Detect: ~ 20 seconds after > 1 minute "On" @50% of F.S.
  - \*Calibration Check: 2 years recommended.
- Note 1:** See page 13 of the [master catalog](#) for environmental specs vs. housing, bar length and digit size.

**Note 2:** E and M grades are the same as Industrial unless otherwise specified.



## Industrial Grade Common Electrical Specifications (Continued)

### AVAILABLE ON EXTERNAL POWER MODELS ONLY:

#### Outputs:

\***Analog Output:** Accuracy & Linearity:  $\pm 0.5\%$  F.S.;  $\pm 0.1$  LSD, Range: 3-24mA (max. load: <1K Ohm).

\***Analog Output Temperature Coefficient:**  $\pm 50$ PPM $^{\circ}$ C

\***Analog Output Isolation To All Other I/O & Power:** >500VDC

\***Relays:** 4 Each/Channel (except NTY, 2): SPDT Form C, 1A Max @ 120VAC/30VDC resistive load only, Contact Protection: 300VAC/DC on all contacts. Speed: +40mS (main loop).

**O.C.T. (Open Collector Transistors):** VCE Max: 30VDC; Ice Max: 30mADC, Speed: +40mS (main loop).

**Note 1:** Relays & O.C.T. have P.O.D. (~100mS) and can be set for fail safe operation (normally on).

**Note 2:** See Digit 11 for default set points and User's Manual for command set via serial control.

**Note:** All  $\pm 1$  LSD and % full scale range unless noted.

#### Option 00 & 17 For Loop Power Only:

**Option 00, 4-20mA Loop Powered:** Burden:  $>3V@4mA$ ,  $\leq 5V@20mA$ ; Range: 3-26mA; Accuracy & Linearity:  $\pm 0.5\%$  of F.S.,  $\pm 1$  LSD.

**Option 17: 10-50mA Loop Powered:** Burden:  $>3V@10mA$ ,  $\leq 5V@50mA$ ; Range: 3-50mA; Accuracy & Linearity:  $\pm 0.5\%$  of F.S.,  $\pm 1$  LSD.

## INPUT SIGNAL SPECIFICATIONS (Digits 8 & 9)

### Options 01 Through 18, A. C. Signal Powered Only:

**FUSE IT!** Use external 1/2 ASB for Volts and 7 ASB for Amps.

#### Important Notes:

1) C.T. are sensitive and limited to the secondary (output) impedance. OTEK A.C. signal powered products present and input impedance of  $\sim 0.2$  Ohms ( $\sim 1V@5A$ ). Make sure your C.T. can drive a  $>0.3$  Ohm load without saturating or losing linearity. Contact Otek for assistance. Best C.T. to use:  $>100:5$  ratio.

2) All inputs for 50-60 Hz lines. Contact Otek for 400 Hz lines.

**Option 01, VAC (P.T.):** Burden: 0.2 Ohm &  $<100mW$ ; Range: 30-140V/40-100Hz; Accuracy & Linearity:  $\pm 0.5\%$  of F.S. Best operating range: 90-140VAC to specifications.

**Option 02, 5 AMP A.C. (C.T.):** Burden:  $<100mW$ ; Range: .5-5A; Accuracy & Linearity:  $\pm 0.5\%$  of F.S. Best range: 2-4 Amps. Note: Not available in "-F" case.

**Option 03, Watts A.C. (C.T. & P.T.):** Not available on case -F. Range:  $>100<600W/50-60Hz$ ; Accuracy & Linearity:  $\pm 0.5\%$  of F.S. at 90-140VAC & 1-4AAC. Best operating range: 100-500 Watts. For 400 Hz lines, use option 03 and specify (03=400 Hz line) after the complete part number.

**Option 04, Hertz VAC:** Not available on case -F. Range:  $>30V<140V$  &  $>30<100Hz$ ; Accuracy & Linearity:  $\pm 0.5\%$  of F.S. For 400 Hz lines, use option 04 and specify (04=400 Hz line) after the complete part number.

**Option 05-14:** Same as options 01 through 04.

### PROPORTIONAL CONTROL?

For proportional control, use a two (or more) channel model. Channel 1 is powered by your signal and the display signal (using a 4-20mA out) to drive the Channel 2 input. Channel 2's 4-20mA output allows you to control your generator. The result: Channel 1 display your AC signal and Channel 2 display it's 4-20mA output. Only Channel 2 needs power for its analog output and/or relays. Use part number NTM-(1, 2, 3, 5, 6, 7, 8, 9 or A)??-269-?21-99). Note: "?"= any available option on Digits 5, 6 & 10 and specify (9=Ch 1 signal power, Ch 2 external power). Also see the new model NTI.

### VAC/DC Signal Power Only:

**Option 16, 7-140VAC/DC:** Now you can monitor and control your AC line, UPS, battery bank or power supply from 7-140VDC/VAC, with only power from the signal. The NTM requires  $>10<80mW$  ( $\sim 3mA-20mA$ ). Imagine the possibilities! Almost like analog (only signal wires), but with 21st century digital technology ready for your PAC/DCS/SCADA system.

Scaling: 7-140VDC in =7.0-140.0 Digital Display & 5-100% bargraph with alarm pointers. See Digits 13 & 14 for custom calibration and scale.

**Accuracy & Linearity:**  $\pm 0.5\%$  of full scale.



# INPUT SIGNAL SPECIFICATIONS (Digits 8 & 9)

NTM-5

## AVAILABLE ON EXTERNAL POWER MODELS ONLY

**Alarm Outputs (Signal Power):** Open collector transistors (4) optional. See the ordering information on pages 19-11, digit 11, option 1. For relays, contact Otek (custom).

**4-20mA Analog Output:** Custom, contact Otek (requires >1 watt from input signal).

**Option 17: 10-50mA Loop Power:** See option 00 & 17 on page 4 (first column).

**Option 18: 10-500mADC Signal Power:** Calibration: 10-500mADC=10-500 & 5-100%. For other calibrations, use digit 14 and specify.

### AVAILABLE ON EXTERNAL POWER ONLY

**Option 20: 4-20mA:** The burden on the loop is only 0.5V@20mA (25 Ohm) and you can use the math functions for converting to flow, instantaneous or totalizer.  
Accuracy:  $\pm 0.5\%$  of F.S.  $\pm 1$  digit

**Options 21-24: VDC:** Input impedance is 1 Mega Ohms on all VDC ranges.

Input impedance 1M  $\Omega$   
Range: Per Option  
Accuracy & Linearity:  $\pm 0.5\%$  of F.S.  $\pm 1$  digit

**Options 25 & 26, mADC:** Since the **NTM** is 2V full scale (2,000 Counts) the "Shunt" resistors used are 100 Ohms for 10mA and 10 Ohm for 100mADC.

Input impedance **25:** 50 $\Omega$ ; **26:** 5 $\Omega$ ;  
Accuracy & Linearity:  $\pm 0.5\%$  of F.S.  $\pm 1$  digit

**Option 27, Watts DC:**  
VZin: 10M  $\Omega$ /AZin: 1.0 $\Omega$ , 5W  
Range: 1W  
Accuracy & Linearity:  $\pm 0.5\%$  of F.S.  $\pm 1$  digit

**Option 28, Watts DC (1Vx1V):**  
VZin: 1M for both inputs  
Range: 0-1V  
Accuracy & Linearity:  $\pm 0.5\%$  of F.S.  $\pm 1$  digit

**Option 29: Custom:** Use this option to describe any custom input, scale or modification to the **NTM** and contact us for feasibility and cost.

**Options 30-34, Volts RMS:** Here we use a **True RMS-DC** Converter for accurate ( $\pm 0.1\%$ ) measurement of sine waves up to 10KHz. For 10-20KHz and SCR accuracy is  $\pm 1\%$ .

VRMS: Zin: 1M $\Omega$   
Range; per options;  
Accuracy & Linearity:  $\pm 0.5\%$  of F.S.  $\pm 1$  digit

**Options 35-37, Amps RMS:** We use a **True RMS-DC** Converter for accurate ( $\pm 0.1\%$ ) measurement of sine waves up to 10KHz. For 10-20KHz and SCR accuracy is  $\pm 1\%$ .

Zin: **35 (0.1A):** 2 $\Omega$ ; **36 (1A):** 0.2 $\Omega$ ;  
**37 (5A):** 0.04 $\Omega$ ; Range: Per option  
Accuracy & Linearity:  $\pm 0.5\%$  of F. S.  $\pm 1$  digit

**Options 38 & 40, Watts RMS:** Here we use a **True RMS-DC** Converter for accurate ( $\pm 0.1\%$ ) measurement of sine waves up to 10KHz. For 10-20KHz and SCR accuracy is  $\pm 1\%$ . Input impedances vs. range are the same as for VDC & mADC ranges.

**Option 38 (1Vx1VAC):**  
Zin: 1M $\Omega$  for both inputs Range: 1V RMS  
Accuracy & Linearity:  $\pm 0.5\%$  of F.S.  $\pm 1$  digit.

**Note:** Always use P.T. & C.T. for options 33, 34, 40, 42, 43 & 44.

**Option 40 (120VACx5AAC C.T.):**  
Zin: 1M for V & 0.04 $\Omega$  for I  
Range: 0-750W  
Accuracy & Linearity:  $\pm 0.5\%$  of F.S.  $\pm 1$  digit

**Note:** Option 40 (120V/5A) includes the shunt (0.04 Ohms/20W) on connector only for 5A C.T.

**Options 41-44, Hertz:** We use an **F-V** to accept frequencies up to 20KHz and amplitudes from 1-400V peak or dry contact or open collector transistor (O.C.T.). For 50 to 440 Hz power line frequency measurement, use Option # "44."

**Option 41 (10KHz/5V Logic):**  
Zin: 1M  
Range: 30-10KHz  
Accuracy & Linearity:  $\pm 0.5\%$  of F.S.  $\pm 1$  digit

**Option 42 (120V, 40-100Hz):**  
Zin: 1M  
Range: 50-150VC/30-100Hz  
Accuracy & Linearity:  $\pm 0.5\%$  of F.S.  $\pm 1$  digit

**Option 43 (240V, 30-100Hz):**  
Zin 1 M; Range: 100-260V/30-100Hz  
Accuracy & Linearity:  $\pm 0.5\%$  of F.S.  $\pm 1$  digit

**Option 44 (120V, 500 Hz):**  
Zin: 1 M  
Range: 50-150V/300-500Hz  
Accuracy & Linearity:  $\pm 0.5\%$  of F.S.  $\pm 1$  digit



**Option 45: Strain-Gage ( $\geq 300 < 4K$  Ohm):** These are typically "Monolithic" **S-G** that require constant voltage (preferably) excitation. We use 4.096V for high stability and accuracy. Use option 29 and **specify** your S-G sensitivity and the **NTM** display at Zero and Full Scale.

Excitation: 4.096V, 50 PPM/°C

Range:  $\pm 300-4K \Omega$

Accuracy & Linearity:  $\pm 0.5\%$  of F.S.  $\pm 1$  digit

Note on S-G: Some S-G offer +/- 1VDC or 4-20mA condition output. Use Option 29 and specify.

**Option 47: RTD (PT100): Note:** For options 47 & 48 you can change °C to °F and RTD type via serial port.

We excite your 2, 3 or 4 wire RTD with 200 $\mu$ A to avoid the "self heating" effect. The range of the **NTM** is the same as your **RTD** typically -200°C to +800°C (-328 + 1562°F). You can place the decimal point at will (typically -200.0 to 800.0). The **PT100** has a temperature coefficient of 0.00385 Ohms/Ohm/°C. (For legacy 0.00392 TC (known as ANSI 392) contact **O TEK** and use Option "29".

Accuracy:  $\pm 0.5\%$  of F.S.  $\pm 1$  digit, plus sensor's error.

Note: For 2 wire, jump - S to -E and +S to +E. For 3 wire only jump -S to -E.

**Option 48: RTD (PT1000):** Same as PT100 except it is 1000 Ohms at 0°C instead of 100 Ohms @ 0°C. The same technique is used for copper **RTD** (10 Ohm), contact **O TEK**. Same connection as Option 47 apply.

Accuracy:  $\pm 0.5\%$  of F.S.  $\pm 1$  digit, plus sensor's error.

**Note:** For long distances (> 300') use a 4-20mA transmitter such as our model **NTY** from our New Technology series.

**Option 50: Thermocouple (Type J):** This **TC** has a range of -210 to +760°C (-350 + 1390°F). Its color is white (+) and Red (-), cold junction (CJ) is at the connector. Make sure the connections from the **NTM** and your **TC** are as close to the **NTM** entrance as possible to avoid errors. If you short out the **NTM's** +**TC** & -**TC** together, the **NTM** will read the ambient temperature at the junction due to its built-in C.J.C.

**Note:** You can change °C to F and TC type via serial port.

Accuracy:  $\pm 2^0$  F.S. of signal input.

**Option 51: TC (Type K):** This is yellow (+) and red (-) and has a range of -270 + 1370°C (-440 + 2500°F). The same notes as Option 50 apply.

**Accuracy:**  $\pm 1^0$  F.S. of signal input.

**Option 52: TC (Type T):** This blue (+) and red (-) **TC** has the range of -270<sup>0</sup> + 400°C (-440 + 750°F). Same notes as Option 50 apply.

Accuracy:  $\pm 2^0$  F.S. of signal input.

**Option 53: pH (Acidity):** We use a FET input ( $10^{15}$ ) amplifier and calibrate the **NTM** for 0-14.00 pH using the Industry's standard  $\pm 413$  mV =  $\pm 7$  pH co-efficient.

Note: Not temperature compensated, contact **O TEK** for auto temperature compensation.

Accuracy:  $\pm 0.5\%$  of F.S.  $\pm 1$  digit

**Option 54: ORP (Oxygen Reduction Potential):** Our FET amplifier ( $10^9$ ) accepts the industry standard 2000mV F.S. of the probe and the **NTM** displays it in % (0-100.0%).

Accuracy:  $\pm 0.5\%$  of F.S.  $\pm 1$  digit

**Option 55: %RH:** This conditioner is designed to interface to a typical (capacitance type) 2-3 pF/% of **RH** made by several manufacturers. Use Option "29" and contact **O TEK** to specify your sensor's specifications.

Accuracy:  $\pm 0.5\%$  RH of signal input,  $\pm 1$  digit.

**Option 56 Resistance (0-10K Ohm):**

Want a simple 4-20mA transmitter? Just connect a 10K Ohm (others on request) potentiometer to the **NTM** and control any 4-20mA input valve, motor, transducer, etc.

Accuracy & Linearity is  $\pm 0.5\%$  of F.S.  $\pm 1$  digit

Standard Calibration: 0-10K

Ohms=4-20mA. Use option #29 and specify your calibration. Ideal for linear transducers.



**Option 57, 10-50mA Range:** 10 Ohms input resistance  
Accuracy & Linearity:  $\pm 0.5\%$  of F.S.  
 $\pm 1$  Digit

**Option 58: Serial Input Remote Display/Controller:** Here you can use the unit as a remote display & controller with modified ASCII to alpha-numeric display for DCS SCADA, PLC systems.

See the user's manual for simple commands to use the **NTM** in PAC (Process Automation Control) applications.

#### Digit 10 (Power Input):

#### LOOP & SIGNAL POWER ONLY:

**Digit 10, Option 0, Powerless, No Power Required:** The **Input Fail** detect/Alarm (patent pending) flashes the display "INPT FAIL (i n P t F a i l)" and transmits this serial message for ~20 seconds, after which it will cease. This feature is available in all Powerless™ models. If desired on powered models, use option **9** on **Digit 14** and specify "input fail detection." Signal Fail Requirement: Unit must be "On" for at least 1 minute at  $>50\%$  of full scale for it to operate.

#### EXTERNAL POWER ONLY:

**Digit 10, Option 1, USB Powered:** The NTM series requires  $>.1 < 1.5$  Watts/Channel (worst case, fully loaded) meaning that you can power it through the USB port, but this option eliminates the isolation from USB to input signal. Analog output remains isolated contact OTEK for more details or use options 2-4.

#### Digit 10 (Power Input): (Continued)

#### EXTERNAL POWER ONLY:

**Digit 10, Option 2, 5VDC:** 5VDC is used to drive the relays ( $<50\text{mA}/\text{relay}$ ) and/or the DAC via internal isolated 5-30VDC-DC ( $<200\text{mA}$ ). If you order relays and analog out, you will need  $\sim 300\text{mA}/\text{channel}$ . This option is also isolated from the input signal.

**Digit 10, Option 3, 7-32VDC:** Same as option **2** but with wide input range of 7-32VDC. Efficiency:  $>75\%$ .

**Digit 10, Option 4, 90-265VAC:** This option accepts 50-60Hz. For 100-300VDC or 400 Hz, use **Digit 10**, option **9** and specify. Efficiency:  $>70\%$ .

#### Digit 11 (Control Outputs):

#### EXTERNAL POWER ONLY:

**Digit 11, Control Outputs: Options 1, 3, 5 or 7: Open Collector Transistors (O.C.T.):** They are **NOT** isolated from each other (common emitter) but are **isolated** between channels and can sink a maximum of 30 mA and sustain a maximum of 30V<sub>CE</sub> (the O.C.T. are normally used to drive S.S.R.). When you order option **2, 4, 6 or 8** (Relays), we use the O.C.T. to drive the relays.

**NOTE:** You can use the internal isolated 5VDC power to drive loads with the O.C.T. Total maximum current available is 50mADC.

#### Digit 11 (Control Outputs): (Continued)

#### EXTERNAL POWER ONLY:

**Digit 11, Options 2, 4, 6 or 8: Relays:** are S.P.D.T. (1C) and can switch maximum resistive loads of 1 Amp @ 120 VAC or 30 VDC. They include 300V varistors at their contacts. Inductive loads must be attenuated by the user.

#### AUTOMATIC BAR COLORS:

**Limits/Colors Factory default** (% of Full Scale): Also see digit 14.

**Low-Low Limit ( $<10\%$ ):** Red Bar, OCT1/K1 "ON"

**Low Limit ( $<20\%$ ):** Yellow Bar, OCT2/K2 "ON"

**High Limit ( $>80\%$ ):** Yellow Bar, OCT3/K3 "ON"

**Hi-Hi Limit ( $>90\%$ ):** Red Bar, OCT4/K4 "ON"

**Safe Area ( $>20 < 80\%$ ):** Green bar will follow signal input and if outside the limits, it will change its color to the limit's color (yellow or red).

See commands in the user's manual to customize your bargraph colors.

For other configurations, use option **9** on **Digit 14** (field configurable). Max power consumption per relay: 50mA@5VDC (0.25W). See **Digit 14**.



**Digit 11 (Control Outputs) {Continued}:****EXTERNAL POWER ONLY:**

**External Control:** You can control the O.C.T./Relays via the serial port at will with simple commands. They don't have to be assigned to the bar colors/set points, but are by default.

**Notes:**

1. Digit **11** is governed by Digit **7** (# of Channels) & Digit **4** (Housing). Reason: Digit **11** can **NOT** have more channels than permitted by Digit **7** or it cannot fit in the housing (Digit **4**).

**Digit 12 (Analog /Power Output):****EXTERNAL POWER ONLY:**

**Digit 12, Analog Output, Options 1, 3, 5 or 7:** This isolated output is factory set to follow the input (0-F.S. in=4-20 out) but can also be set for other outputs or serially controlled by simple commands via the serial port. For other outputs, use option **9** and specify, including reverse scale (4-20=20-4), bipolar and PID. Power consumption: 200mA@5VDC (1W). Accuracy & Linearity:  $\pm 0.5\%$  of full scale.

**Digit 12 (Analog /Power Output):**

{Continued}

**Analog Output External Control (Use Option 9 and specify):** A) 0-100mVDC in=4-20mA out; B) 0-10K Ohm in=4-20mA out; C) Use options 58, 68, 78 or 88 and control it via serial port.

**Digit 12, 30 VDC Out, Options 2, 4, 6 or 8:** Use this option to power your 4-20mA transmitter or other transducer. Maximum current is 25mA. It's isolated and is the same power source we use for 4-20mA out. Power consumption: 200mA@5VDC (1W)/channel.

1. This digit 12 is governed by digits 4 (Housing) & 7 (# of Channels). Reason: Digit 12 cannot have more outputs than input channels (Digit 7), which is governed by Digit 4 (Housings).

**Digit 13 (Scale Plate):**

**Digit 13, Scale Plate:** Option **0** is a standard scale plate that reads 0-100%. Use option **9** for custom printing and contact Otek.

**Digit 14 (Range/Calibration):**

**0=** Factory Default: 0-Full Scale Input=0-100% bar and 0-100.0 digits. Colors: <10>90%: Red; <20>80%: Yellow; >20<80%: Green. Use Option **9** (custom) and contact Otek. Also see Control Outputs (Digit 11).

**Bargraph Default:** 0-full scale=0-100%. You can program it for single pointer, or three or five bars via the serial port.

**Important Note on A.C. Powerless**

The NTM, UPM & NT Series can extract energy from your A.C. signal to power itself and opto isolated serial, optional O.C.T. (Digit 11, options 1, 3, 5 or 7), and to power the optional 4-20mA output (Not 20-4mA out) from a wide input range. External power is required to power the optional relays (Digit 11, options 2, 4, 6 & 8) (200mW each). If you need relays, either use the external powered options on Digits 8 & 9 (33, 37, 40 or 42) and the Digit 10 power input options (1-4) or use Powerless™ options 01-04 on Digits 8 & 9 and Power Input option 09 (custom) on Digit 10 and specify (09=Power for relays and DAC). Result: The signal will power the instrument and will include our patented **Signal Fail Detection & Alarm**. The relays and analog output are powered by the external power option (all 100% isolated).

**ABOUT OUR INPUT FAIL DETECTION**

Only available on Powerless™ models. While in normal operation, we store excess energy and use it to power the NTM if and when the signal fails (post mortem).

1 A P E    F A I L





# NTM-5 LOOP POWER VERSION ORDERING INFORMATION 5-1-17

## 1, 2, 3 or 4 CHANNEL LOOP POWERED DISPLAY

**NTM-5**

OTEKS TRC/OLC (3" x 6") Case

NTM-5 5 6 7 8 9 10 11 12 13 14

**SERIAL I/O (1)**

- 0.....USB
- 1.....RS485
- 9.....Custom (Contact OTEK)

**GRADE & CASE\***

- 0.....Industrial & Plastic
- 1.....Industrial & Metal
- 2.....Industrial & Plastic NEMA 4X
- 3.....Industrial & Metal NEMA 4X
- M.....To Mil-Spec & Metal (Contact OTEK)
- E.....To Epri-Nuclear & Metal (Contact OTEK)
- 9.....Custom (Contact OTEK)

**RANGE/CALIBRATION**

- 0.....Standard
- 9.....Custom (Contact OTEK)

**SCALE PLATE**

- 0.....Standard (0-100%)
- 9.....Custom (Contact OTEK)

**ANALOG/POWER OUTPUT**

- 0.....None

**CONTROL OUTPUTS**

- 0.....None

**POWER INPUT**

- 0.....Powerless™ (No Power)

\*Grades E, M & 9 might require an N.R.E. fee.

**# OF CHANNELS**

- 1.....One
- 2.....Two
- 3.....Three
- 4.....Four
- 9.....Custom (Contact OTEK)

**INPUT SIGNAL**

- 00.....4-20mA, All Channels=Input, Loop Power
- 17.....10-50mA, All Channels=Input, Loop Power

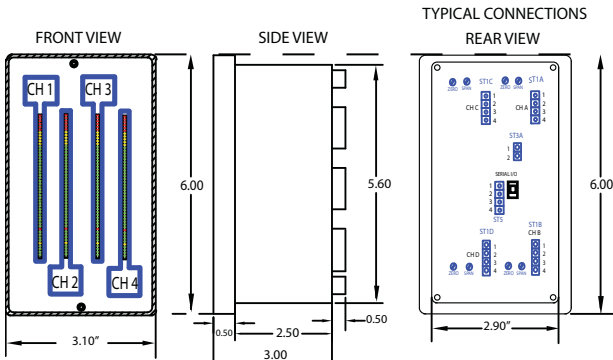

Build Your Own Part  
Number/Receive a  
Quote at:  
[http://www.otekcorp.com/  
configurator/nts/](http://www.otekcorp.com/configurator/nts/)

NOTE: Please READ BEFORE building part number:

1. USB I/O is powered by VUSB. RS485 requires 5V@~3mA.
2. Otek will build to certain nuclear or MIL-Standards but testing and confirmation of compliance, if required, will be quoted as a separate line item.

# NTM-5 SIGNAL POWER VERSION ORDERING INFORMATION 5-1-17

**NOTE: Please READ BEFORE building part number:**

1. If Digit 7 is option 1, then Digits 8 & 9 can only be options 01-04 or 09. If digit 7 is option 2, then Digits 8 & 9 can only be options 01-09. If digit 7 is option 3, then Digits 8 & 9 can be 01-13.

1, 2, 3 or 4 CHANNEL **SIGNAL** POWERED DISPLAY



OTEKS TRC/OLC (3" x 6") Case

NTM-5 5 6 7 - 8 9 10 - 11 12 13 14

**SERIAL I/O (2)**

- 0.....USB
- 1.....RS485
- 9.....Custom (Contact OTEK)

**GRADE & CASE\***

- 0.....Industrial & Plastic
- 1.....Industrial & Metal
- 2.....Industrial & Plastic NEMA 4X
- 3.....Industrial & Metal NEMA 4X
- M.....To Mil-Spec & Metal (Contact OTEK)
- E.....To Epri-Nuclear & Metal (Contact OTEK)
- 9.....Custom (Contact OTEK)

**RANGE/CALIBRATION**

- 0.....Standard
- 9.....Custom (Contact OTEK)

**SCALE PLATE**

- 0.....Standard (0-100%)
- 9.....Custom (Contact OTEK)

**ANALOG/POWER OUTPUT**

- 0.....None

**CONTROL OUTPUTS**

- 0.....None

**POWER INPUT**

- 0.....Powerless™ (No Power)

**# OF CHANNELS (1)**

- 1.....One
- 2.....Two
- 3.....Three
- 4.....Four
- 9.....Custom (Contact OTEK)

\*Grades E, M & 9 might require an N.R.E. fee.

**INPUT SIGNAL (1, 4)**

- 01.....Volts A.C., All Channels, Signal Power
- 02.....5 Amps A.C., All Channels, Signal Power
- 03.....Watts A.C., All Channels, Signal Power
- 04.....Hertz A.C.V., All Channels, Signal Power
- 05.....Mixed 2 Channel.....VAC Ch. 1, AAC Ch. 2, Signal Power
- 06.....Mixed 2 Channel.....VAC Ch. 1, WAC Ch. 2, Signal Power
- 07.....Mixed 2 Channel.....VAC Ch. 1, Hz Ch. 2, Signal Power
- 08.....Mixed 2 Channel.....AAC, Ch.1, WAC Ch. 2, Signal Power
- 09.....Custom (Contact OTEK)
- 10.....Mixed 3 Channel.....V Ch. 1, A Ch. 2, W, Ch. 3 Signal Power
- 11.....Mixed 3 Channel.....V Ch. 1, A Ch. 2, Hz Ch. 3 Signal Power
- 12.....Mixed 3 Channel.....V Ch. 1, W Ch. 2, Hz Ch. 3 Signal Power
- 13.....Mixed 3 Channel.....A Ch. 1, W Ch. 2, Hz, Ch. 3 Signal Power
- 14.....Mixed 4 Channel.....V Ch. 1, A Ch. 2, W Ch. 3, Hz Ch. 4 Signal Power
- 16.....7-140 Volts A.C./D.C., All Channels, Signal Power
- 18.....10-500mADC, All Channels, Signal Power

Build Your Own Part Number/Receive a Quote at:  
<http://www.otekcorp.com/configurator/nts/>

NOTES (Continued):

- 2. USB I/O is powered by VUSB. RS485 requires 5V@~3mA.
- 3. Otek will build to certain nuclear or MIL-Standards but testing and confirmation of compliance, if required, will be quoted as a separate line item.
- 4. Multi-channel input signal is the same for all channels.

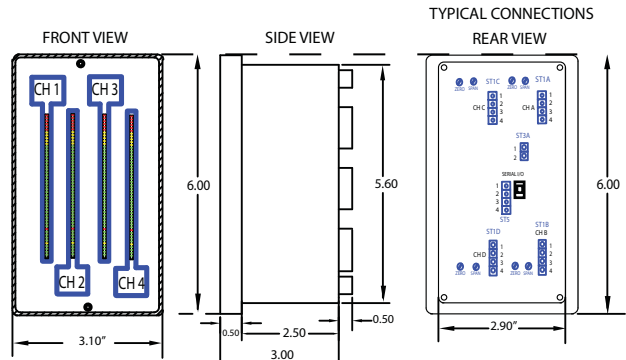

# NTM-5 EXTERNAL POWER ORDERING INFORMATION 5-1-17

**NOTE: Please READ BEFORE building part number:**

1. If digit 10 is option 1, then digit 5 must be option 0 or 3. USB I/O is powered by VBUS (3mA). RS485 requires 5V@~3mA.

2. If Digit 7 is option 1, then Digits 11 and 12 can only be options 0-2 or 9. If digit 7 is option 2, then Digits 11 and 12 can only be options 0-4 or 9. If Digit 7 is option 3, then Digits 11 and 12 can option be options 0-6 or 9.

3. The number of outputs (Digits 11 and 12) cannot exceed the number of channels (Digit 7) and cannot exceed the number of Input Signals (Digits 8 & 9).

**SERIAL I/O (1)**

- 0.....USB
- 1.....RS485
- 2.....Ethernet
- 3.....USB & μSD Memory (Pending)
- 4.....RS485 & μSD Memory (Pending)
- 9.....Custom (Contact OTEK)

**GRADE & CASE\***

- 0.....Industrial & Plastic
- 1.....Industrial & Metal
- 2.....Industrial & Plastic NEMA 4X
- 3.....Industrial & Metal NEMA 4X
- M.....To Mil-Spec & Metal (Contact OTEK)
- E.....To Epri-Nuclear & Metal (Contact OTEK)
- 9.....Custom (Contact OTEK)

\*Grades E, M & 9 might require an N.R.E. fee.

**# OF CHANNELS (2, 3)**

- 1.....One
- 2.....Two
- 3.....Three
- 4.....Four
- 9.....Custom (Contact OTEK)

**INPUT SIGNAL (3, 6, 7)**

See Page 12 and enter option number for Digits 8 & 9.

1, 2, 3 OR 4 CHANNEL **EXTERNAL** POWERED CONTROLLER

OTEKS TRC/OLC (3" x 6") Case

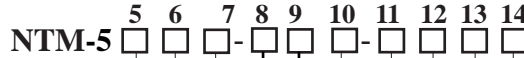

- RANGE/CALIBRATION**
- 0.....Standard
  - 9.....Custom (Contact OTEK)

**SCALE PLATE**

- 0.....Standard (0-100%)
- 9.....Custom (Contact OTEK)

**ANALOG/POWER OUTPUT (2, 3)**

- 0.....None
- 1...CH. 1.....4-20mA Out
- 2...CH. 1.....30V Out
- 3...CH. 1 & 2.....4-20mA Out
- 4...CH. 1 & 2.....30V Out
- 5...CH. 1, 2 & 3.....4-20mA Out
- 6...CH. 1, 2 & 3.....30V Out
- 7...CH. 1, 2, 3 & 4.....4-20mA Out
- 8...CH. 1, 2, 3 & 4.....30V Out
- 9.....Custom (Contact OTEK)

**CONTROL OUTPUTS (2, 3)**

- 0.....None
- 1...CH. 1.....O.C.T. (4)
- 2...CH. 1.....Relays (4)
- 3...CH. 1 & 2.....O.C.T. (8)
- 4...CH. 1 & 2.....Relays (8)
- 5...CH. 1, 2 & 3.....O.C.T. (12)
- 6...CH. 1, 2 & 3.....Relays (12)
- 7...CH. 1, 2, 3 & 4.....O.C.T. (16)
- 8...CH. 1, 2, 3 & 4.....Relays (16)
- 9.....Custom (Contact OTEK)

**POWER INPUT (1)**

- 1.....Non-Isolated USB
- 2.....Isolated 5VDC
- 3.....Isolated 7-32VDC
- 4.....Isolated 90-265VAC
- 9.....Custom (Contact OTEK)

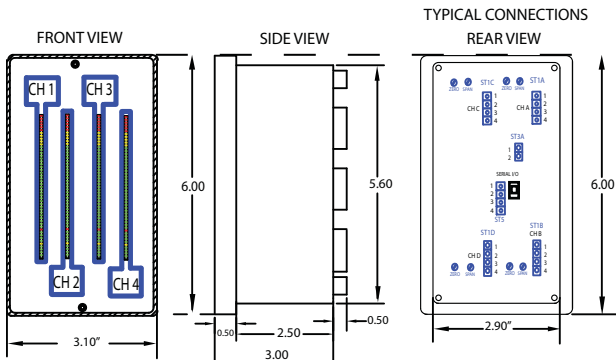

**NOTES (Continued): Please READ BEFORE building part number:**

4. Otek will build to certain nuclear or MIL-Standards but testing and confirmation of compliance, if required, will be quoted as a separate line item.

# MODEL NTM-5 DIGITS 8 & 9 INPUT SIGNAL ORDERING INFORMATION 5-1-17

AVAILABLE ON **EXTERNAL POWER** MODELS ONLY

## INPUT SIGNAL

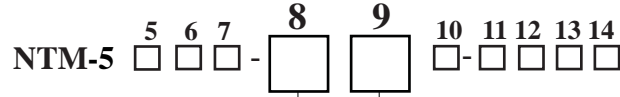

**INPUT SIGNAL, All channels same input. (3, 6, 7)**

20.....	4-20mA F.S.
21.....	100mV DC F.S.
22.....	1VDC F.S.
23.....	10VDC F.S.
24.....	100VDC F.S.
25.....	10mADC F.S.
26.....	100mADC F.S.
27.....	Watts DC (1Vx1A) F.S.
28.....	Watts DC (1Vx1V) F.S.
29.....	Custom (Contact OTEK)
30.....	0.1V RMS F.S.
31.....	1V RMS F.S.
32.....	10V RMS F.S.
33.....	150V RMS F.S.
34.....	250 V RMS F.S.
35.....	0.1A RMS F.S.
36.....	1A RMS F.S.
37.....	5A RMS F.S.
38.....	W RMS (1Vx1VAC) F.S.
40.....	W RMS (120Vx5A AC) F.S.
41.....	Hertz (10KHz/5V Logic) F.S.
42.....	Hertz (120VAC/40-100 Hz) F.S.
43.....	Hertz (240VAC/30-100 Hz) F.S.
44.....	Hertz (120VAC/500 Hz) F.S.
45.....	Strain-Gage ( $\geq 300 < 4K$ Ohm)
47.....	RTD (PT100)
48.....	RTD (PT1000)
50.....	TC (Type J)
51.....	TC (Type K)
52.....	TC (Type T)
53.....	pH (0-14.00)
54.....	ORP (0-2000mVDC)
55.....	% RH (Specify Sensor)
56.....	Resistance (0-10K $\Omega$ )
57.....	10-50mA F.S.
58.....	None (Serial Input Remote Meter)

**MIXED INPUT SIGNALS (2 CHANNELS)**

60.....	Ch.1: 1V; Ch.2: 1A (.2 $\Omega$ ) RMS
61.....	Ch.1: 10V; Ch.2: 1A (.2 $\Omega$ ) RMS
62.....	Ch.1: 100V; Ch.2: 1A (.2 $\Omega$ ) RMS
63.....	Ch.1: 100V; Ch.2: 50mVRMS
64.....	Ch.1: 150V; Ch.2: 5A (.04 $\Omega$ ) RMS
65.....	Ch.1: 250V; Ch.2: 5A (.04 $\Omega$ ) RMS
66.....	Ch.1: 150V; Ch.2: 100Hz (120 V Line) RMS
67.....	Ch.1: 250V; Ch.2: 100 Hz (240V Line) RMS
68.....	None, Serial Input Only
69.....	Custom (Contact OTEK)

**MIXED INPUT SIGNALS (3 CHANNELS)**

70.....	Ch.1: 1V; Ch.2: 1A (.2 $\Omega$ ); Ch.3: W RMS
71.....	Ch.1: 10V; Ch.2: 1A (.2 $\Omega$ ); Ch.3: W RMS
72.....	Ch.1: 100V; Ch.2: 1A (.2 $\Omega$ ); Ch.3: W RMS
73.....	Ch.1: 100V; Ch.2: 50mV; Ch.3: W RMS
74.....	Ch.1: 150V; Ch.2: 5A (.04 $\Omega$ ); Ch.3: W RMS
75.....	Ch.1: 250V; Ch.2: 5A (.04 $\Omega$ ); Ch.3: W RMS
76.....	Ch.1: 150V; Ch.2: 5A (.04 $\Omega$ ); Ch.3: 100Hz RMS
77.....	Ch.1: 250V; Ch.2: 5A (.04 $\Omega$ ); Ch.3: 100 Hz RMS
78.....	None, Serial Input Only
79.....	Custom (Contact OTEK)

**MIXED INPUT SIGNALS (4 CHANNELS)**

80.....	Ch.1: 150V; Ch.2: 5A (.04 $\Omega$ ); Ch.3: W; Ch.4: 100Hz RMS
81.....	Ch.1: 250V; Ch.2: 5A (.04 $\Omega$ ); Ch.3: W; Ch.4: 100 Hz RMS
82.....	Ch.1: 120V; Ch.2: 5A (.04 $\Omega$ ); Ch.3: W; Ch.4: 500 Hz RMS
83.....	Ch.1: 250V; Ch.2: 5A (.04 $\Omega$ ); Ch.3: W; Ch.4: 500 Hz RMS
88.....	None, Serial Input Only
89.....	Custom (Contact OTEK)

**NOTES:**

3. The number of outputs (Digits 11 and 12) cannot exceed the number of channels (Digit 7) and cannot exceed the number of Input Signals (Digits 8 & 9).

6. For 400 Hz line, use option 29, 69, 79 or 89 and specify input. Peak & Hold to 50KHz function on request.

7. 50mV shunt not included.

Build Your Own Part  
Number/Receive a  
Quote at:  
[http://www.otekcorp.com/  
configurator/nts/](http://www.otekcorp.com/configurator/nts/)

# NTM-5 MECHANICALS AND TYPICAL CONNECTIONS

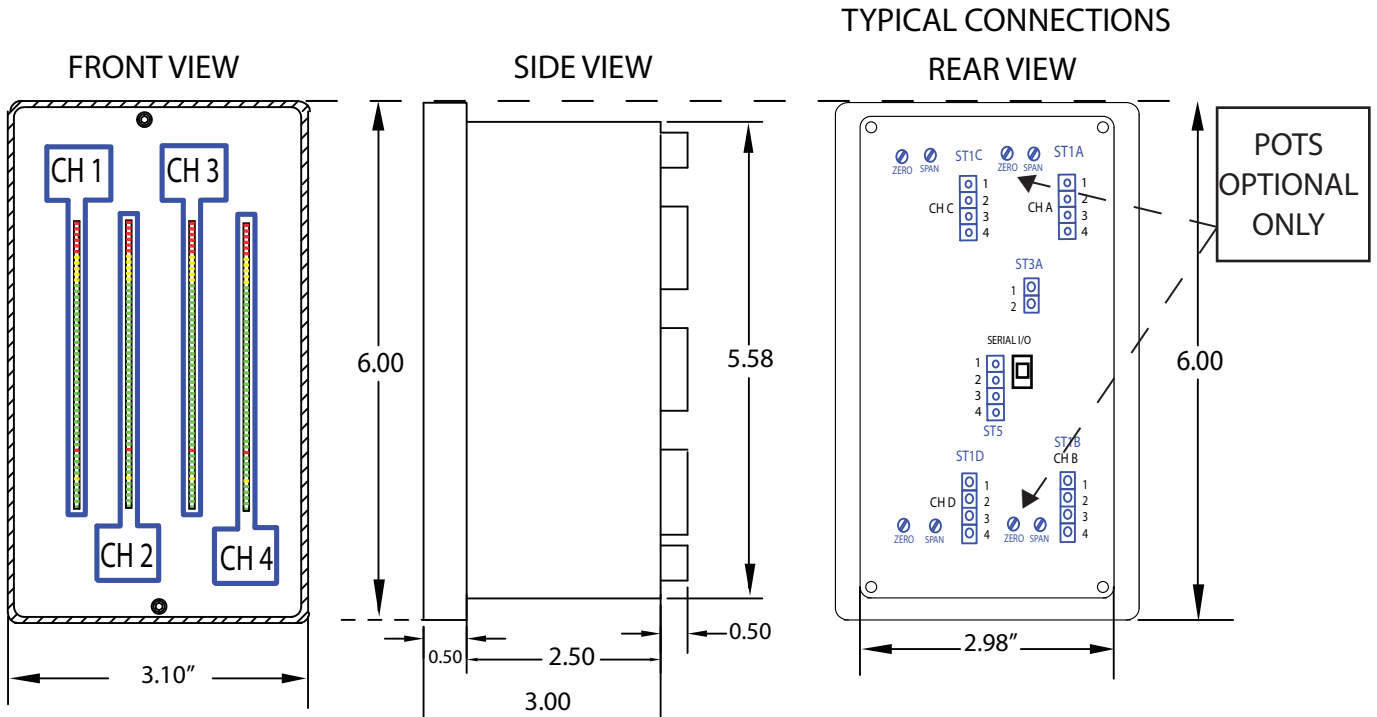

**NOTE:** 1" DEPTH IS FOR METAL (OPTIONS I, M or E) ONLY. PANEL CUT-OUT: 3.05x5.6"

**Note: Standard display configuration:**

1. Digit 3, Option 1: (1 Ch. Only): Location: Ch. 3, text to the right and above digits.
2. Digit 3, Option 2: (2 Ch. Only): Location: Ch. 1 on Ch. 1, Ch. 2 on Ch. 3, text to the right & above digits.
3. Digit 3, Option 3: (3 Ch. Only): Location: As shown. Text is both above/below digits.
4. Digit 3, Option 4: (4 Channel): Location: As shown.
5. Digit 3, Option 9: Specify your needs.

- Mounting:**
1. Remove Filter
  2. Twist Mounting Tabs (2) Clockwise
  3. Replace Filter

**NOTE:** ZERO & SPAN POTS ON REQUEST ONLY.

**NEW TECHNOLOGY METER BLOCK DIAGRAM/CHANNEL**

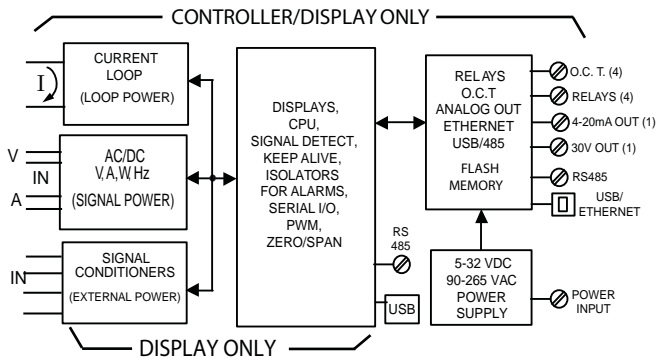

**DOWNLOADS:**  
For manuals,  
user-software or  
drivers:  
[www.otekcorp.com](http://www.otekcorp.com)

SEE CUSTOMIZED USER'S MANUAL  
FOR SPECIFIC  
CONNECTIONS at:

<http://www.otekcorp.com/configurator/nts/>