

NEW

**PROGRAMMABLE BARGRAPH-CONTROLLER
SHORT DEPTH UNIT FOR TIGHT SPACES**
Nuclear, Mil-Spec or Industrial Grade

**MODEL
HI-Q219**
(ATB)

FEATURES:

- Math Function: +, -, x, ÷, √
- Polynomial: to 9th order
- X-Y table: 25 Point
- Environment: MIL-STD 461, 167, 901,810, EPRI 102323
- SV & V: HW & FW. Over 10 years and thousands of units in Nuclear (Class 1E), MIL and Industrial environments
- Automatic Tricolor
- Over 30 input signal conditioners
- Any power input AC or DC
- 4 Relays or 8 O.C.T. (Alarms)
- 4-20mA, 0-5 V analog out
- Serial: 232,485, USB
- Ethernet, Can, Modbus: On request.
- Housing Depth <2.2"
- Plastic or Metal housing
- Euro Plug-In connectors
- Custom Scale Plates
- Free GUI
- Optional Front Panel Key Pad
- Lifetime Warranty

DESCRIPTION

The model HI-Q219 offers the same rugged hardware and firmware as the popular model HI-Q119 (and other bargraphs of the HI-Q family) but it is less than 3" deep. This makes it ideal for applications where space behind the panel is limited. Plastic or metal housing. Both Mil-Standard and EPRI 102323 compliant versions are available on request.

OBSOLESCENCE:

The new HI-Q219 is "protected" against obsolescence due to its 100% modular design-including the CPU. Our adherence to NUREG-0700 & 0-800 (HMI), EPRI 102323 (EMI/RFI) and choices of several Mil-Standards have made the HI-Q series the controller/monitor of choice for a great variety of different installations world-wide.

PRELIMINARY

Actual Size 1 3/4 x 6" x <3"

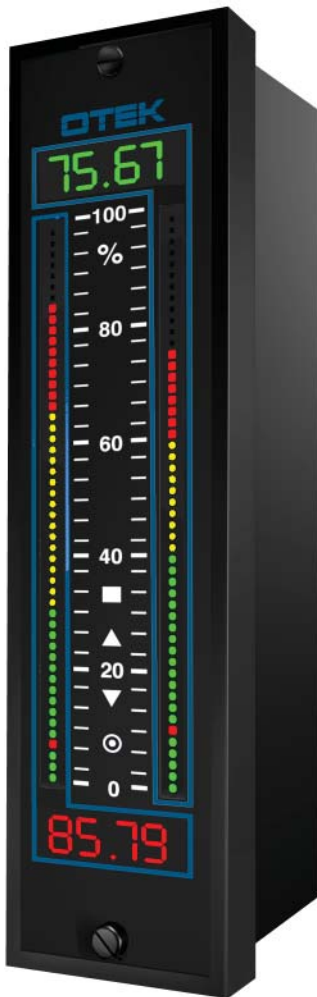

SPECIFICATIONS

(Basic Mainframe @ 25°C)

- A/D: 18 Bit:
- Sampling: 16/Second
- Accy. & Resolution: ±0.01%
- Temp. Drift: ± 50 PPM/°C
- CMRR: > 90 dB
- CMV: ± 2 VDC
- Zero, Span, Averaging, Tare, Linearizer: Configurable
- DAC: 16 Bit:
- Accy. & Linearity: ±0.01%
- Isolation: 500 VDC
- Compliance: Internal (30 V@30mA)
- Relays: 1A SPDT (10A on request)
- O.C.T.: 30 VCE/250mA Sink
- Power: 5-300 VDC, 90-265 VAC (10W max)
- Bargraph: Auto-tricolor, 51. (RGY), 2% Resolution
- Digital: 4 digit (9999), ±0.01% Resolution
- Environmental: See Case Options
- Input Signals: See Signal Conditioners

HI-Q COMPARISON CHART

SERIES	HI-Q219	HI-QTEK HI-Q119	Replaces any 6" tall
Relays (4)	1A	10A	Prime
DAC	1 Ea.	Up to 2 Ea.	Sigma
Input Signals	>30	<10	Dixson
Serial I/O	Any	232,422,485	Ametek
I/O Isolation	All	DAC & Serial	VMI
Diagnostics	Yes	Yes	Weschler
Depth	<3"	4" & 8"	Westinghouse
Warranty	Lifetime	Lifetime	

520-748-7900
FAX: 520-790-2808
E-MAIL: sales@otekcorp.com
<http://www.otekcorp.com>

OTTEK™
CORP.
SINCE 1974

4016 E. TENNESSEE ST.
TUCSON, AZ. 85714 U.S.A.

MADE
IN
USA



BENEFITS

OF THE

HI-Q™

(High I.Q.)

DESCRIPTION: The HI-Q Controllers consist of several products with sub-products. All the products share similar hardware and software with the main difference being their package and display. Once you have familiarized yourself with one, you will know them all! By using common software and hardware, we realize R&D and production savings and we are happy to pass them on to you.

INTERFACE

OPERATOR:

* **Bargraphs** are used for quick trend indication. The operator can, at a glance, tell where the process is.

* **Digital Display(s)** are used to give accurate process indication and set point control or calculate values in engineering units. They are also used to display the menu-driven prompts.

PROCESS:

All HI-Q intelligent controllers offer five methods of controlling your process:

- a) Current: 4-20mA, 1-5mA, 0-20mA (including PID), directly or inversely proportional.
- b) Voltage: 0-5VDC & 1-5VDC (or 5-0 & 5-1VDC) or any other ranges in between.
- c) Four (4) or six (6) SPDT 10Amp relays.
- d) Open collector Bi MOS outputs.
- e) The serial port (USB, RS232, 422 & 485)

BENEFITS

* **SV & V:** The HI-Q Series software has been verified & validated as trouble/glitch free per IEEE Std. The hardware has passed several Mil-Std's, such as 461, 462, 617, EPRI 102323 & others. If we don't have it, we'll make it!

* **Low Cost-High Performance:** When you buy the HI-Q, you buy a "Computing Controller," not just an instrument. Its performance-to-price ratio is unsurpassed in the industry. Only the specific functions that you will need are selected and included; no need for unnecessary extras.

SYSTEM:

* **Use the Isolated RS Translator** to interface with other industry standard USB, RS-232C/RS-422 or RS-485 devices with open or proprietary protocols. If they are "RS" and "ASCII" compatible, the HI-Q can communicate with them.

* **Stand Alone: as Single or Multi Loop Controller** Whether under the protection of a factory environment or in the open field, the HI-Q will meet and exceed your expectations.

* **CONFIGURATION:** Just Upload OTEK's **FREE Windows Navigator™ (GUI)** and configure or re-configure your HI-Q without an instruction manual in minutes!



COMMON FEATURES

* **Ready to Use:** Just apply power, select the commands, set your limits and start controlling.

* **Automatic Tricolor:** Changes colors (Red, Blue, Purple, Green, Amber) upon reaching a limit. **Flashing & dimming** of the displays are under your control.

* **Password Security:** You can enable or disable the front panel keypad (Optional Keypad).

* **Emergency Shut Down:** Any three keys held down simultaneously will shut down the controller sending all outputs to a "Fail Safe"(Off) state.

* **Power on Test (POT):** Will test every major section of its hardware, software and firmware and flag any malfunctions.

* **C.O.P. (Computer Operating Properly):** Checks the operation of its internal algorithms. You can disable it.

* **Mathematical Functions:** Insert the math function. Transmit and/or control with the result.

* **Polynomials and Look Up Tables:** Make your own or use the preprogrammed polynomials to 9th order.

* **Self Diagnostics:** The HI-Q will detect major software/hardware failure & warn you via its display/serial port.

* **Modular Design For Long Life Expectancy**

* **Lifetime Warranted**

* **Obsolescence Proof:** All critical components have 2nd source and/or are in modules, so they can be replaced/redesigned efficiently and economically.

* **Customs:** Very economical and efficient, thanks to its modular design.

Some Commands You Can Enter Via the Optional Keypad (More Via the Serial Port) or GUI

- Security-Code-Restricted Access
- Zero Offset/Tare
- Full-Scale Range
- Colors (LED or LCD backlight) (Any available mix)
- Intensity: None to Max.
- Blinking On/Off
- Filtering (averaging)
- Danger Alarms(Warning/Stop)
- Relays (4 or 6), Bi Mos (8) On-Off
- Current Loops 4-20mA(0-5V out)

1 → 3	Assign any Channel to any Display & Relays to Channels or External Commands
4 → 2	
A/M	* Auto/Manual Process Control
K	Assign any Constant to any Channel
Δt	Assign any Delay to any Output
P	Proportional
I	Integral
D	Derivative
	Your Own Custom Commands
oops!	Reset to Default Parameters
Poly	Ours or Your Polynomials/Tables
...!!	* Process Predictability (Signal(s) vs Time (Contact Otek)

- Selectable
- Alarm w/or w/out Delay
- Watchdog Timer
- COP& Self-Diagnostics
- Store any Non-Volatile Command in Memory
- Any Address Alphanu-meric
- Any speed 1.2 to 19.2 KBPs
- Any Resolution (down to 1÷50,000)

THE BENEFITS OF THE "HI-Q" (Continued)

HI-Q219, Continued

Now you can monitor and control your process from the comfort of your control room or at the site with an inexpensive PC & OTEK's complete line of **Programmable Intelligent Controllers**. Use them either as a standalone unit or as part of your DCS or SCADA system.

CONFIGURATION with OTEK's New **Windows Navigator™** (PC G.U.I.) is so fast & easy that no instruction manual (other than for connections) is required! Just Plug in your PC terminal, upload our **FREE** program and start selecting your configuration. Within minutes, you will be done, and you can even email it to remote locations!

For a **FREE** copy of the Windows Navigator™, visit our website at www.otekcorp.com and click on Windows Navigator™.

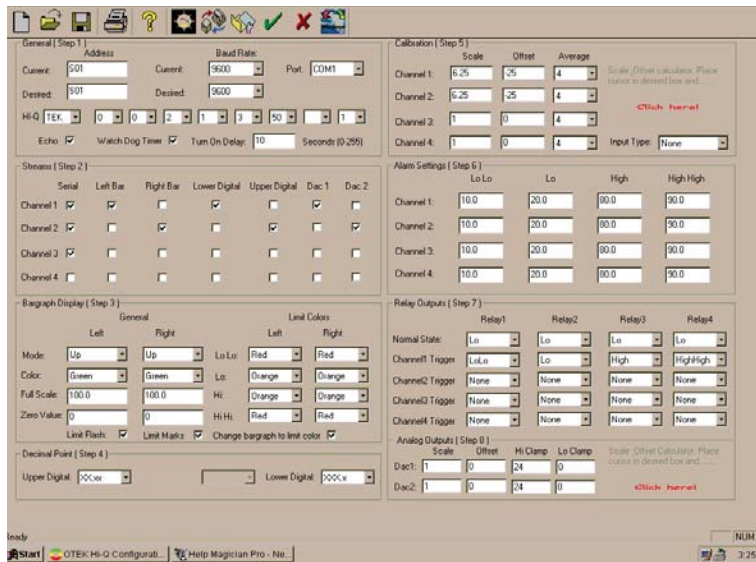

OTEK's "HI-Q" line of **Programmable Intelligent Controllers** with their built-in and isolated signal conditioners will connect directly to your sensor and/or transducer and even power it. All you have to do is to connect & power up. We will even preprogram the "HI-Q" for you if so desired for **"Plug-N-Play"**.

Common Features of the "HI-Q™" Series:

- Math Functions: +, -, x, ÷, √ and More
- Isolated 18-bit A/D w/Signal Conditioners
- Isolated Analog Outputs (4-20mA & 0-5VDC)
- (4 or 6 each) 10A SPDT Relays for On-Off Control
- O.C.T. (250mADC) for Fast On-Off Control
- Isolated 5 & 10-32VDC (24VAC Also) Power Input
- Isolated 90-265VAC or (100-350VDC on Request) Power Input
- 5 VDC Power for Low Voltage Applications
- Look Up Tables for Thermocouples/RTDs
- Polynomials to the 9th Order
- Customer's X-Y (25 Point) Tables
- ZERO • TARE • SPAN • AVERAGE
- All ASCII Characters for Open Protocol
- Programmable Baud Rate & Address
- Isolated RS-232C/422/485 Translator & USB (Ethernet on Request)
- Automatic Tricolor LED Displays with Dimming, Blinking & Pointers
- P.I.D. or Just Plain Proportional Control
- SV & V, Mil-Stds with Self-Diagnostic Capabilities
- Modular Design for Long Life Expectancy
- Lifetime Warranted

What Can the "HI-Q" Series Do for You?

It can accurately and reliably monitor and/or control your process as a standalone unit or as part of a DCS/SCADA for complete factory automation.

From the most basic form as a serial input **remote display** to the most complex as stand alone **Programmable Intelligent Controller**, the "HI-Q" Series will perform to specifications in the oceans, on earth or in outer space, in the Alaskan tundras or in the Tucson deserts.

MILITARY, NUCLEAR, SEISMIC & EPRI TR-102323R3 models are (or being) approved. Contact OTEK™

Where Are the "HI-Qs" Being Used?

Only OTEK's HI-Q Series are in outer space (**Mir & I.S.S.**), military aircraft (**night vision**), naval warships (**Mil-Spec**), nuclear power plants, offshore exploration/drilling, mass transit (**Metro**), biomedical (non-life support), pharmaceutical, agricultural, waste & water treatment, etc.

IS YOUR APPLICATION MORE CRITICAL?

IF YOU DON'T SEE IT, ASK FOR IT!
Our customers **THINK** of the products; we just design them!

B

HI-Q219, Continued

Serial I/O (DIGIT 3): 500 V isolated from other I/O.

Option 1: RS485: 1200-19.2kb, all ASCII (8N1) open protocol screw connector. Add terminating resistor (~300 Ohm) at 1st and last only.

Option 4: USB: 1200-19.2kb, all ASCII (8N1) open protocol "USB Type B."

Any terminal program (Hyperterminal, Procomm, Kermit) will work. For USB download our Driver at www.otekcorp.com.

Option 5: RS232: 1200-19.2kb, all ASCII (8N1) open protocol DB9 connector.

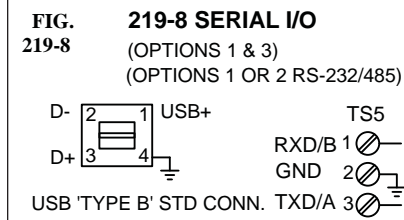

Option 6: Ethernet: 10 Base T, RJ45. Meet present standards to 19.2 KB. Free Driver.

POWER INPUT (DIGIT 4):

All listed I/O options are available. Power requirements vary with options included. The **HI-Q219** with No Control and Power Out (Digit 5 & 6, Option 0) requires under 2.0W (400mA@5VDC) per channel (bargraph).

Options 1,2 & 3 have 500 VDC/AC isolation to all I/O. Option "0" is not isolated.

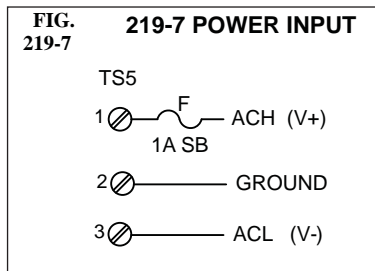

Relays/O.C.T.: Use these options to get relays/O.C.T. Standard is 4 relays, 1A@120VAC/30 VDC resistive load. We can give you 2 each 10 AMP, also SPDT (Form C) on request. Use option #1 for standard or #9 for custom. The O.C.T. (8 ea.) are normally off, com. emitter 30VDC/100mA max. Use option #2 for O.C.T. (Vsat~1.2V)

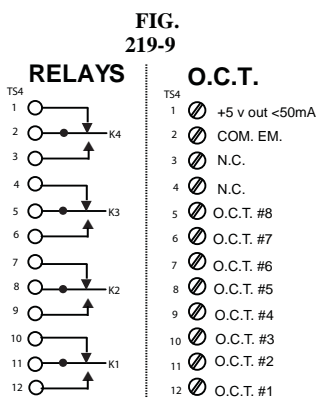

ANALOG & POWER OUTPUTS (Digit 6): You can order 0-24mA (scalable to 4-20mA) or 0-5V. You can also order the isolated 30VDC (30mA) output.

Option 1 & 2: Isolated 0-24 mA:

This option is offset & scaled via the serial port (digit 3) and can be configured for 4-20 (Option 1), 0-20 or 0-24 mA or 0-5 VDC (Option 2) via internal jumpers (standard is 4-20 mA). This option requires under 200 mA@5VDC (1 W) internal power due to step up from 5-30 VDC compliance. Accuracy & linearity is +/- .1% of setting and can drive up to 1K ohms load. For 4-20mA or 10K for 0-5 VDC)

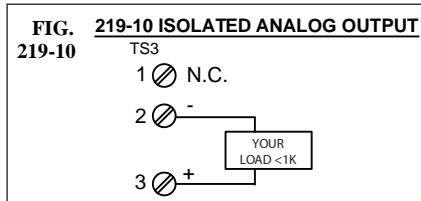

Option 8: Isolated 30 VDC (Compliance)

You can use it to excite your transmitter at up to 25mA. It consumes under one (1.1) Watts at full load.

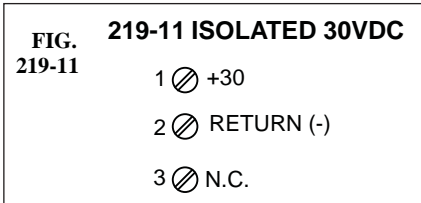

HI-Q219 continued

SIGNAL CONDITIONERS, DIGITS 7 & 8:

The HI-Q219 offers > 30 input signal conditioners that accept inputs directly from your transducer. If not listed, contact Otek. If we don't have it, we'll make it.

Option 00: Serial Input Remote

Display: Here you can use the **HI-Q219** as a remote display/controller with modified (STD.) ASCII to alpha-numeric display for DCS SCADA, PLC systems.

Option 09: Custom: Use this option to describe any custom input, such as TTL/CMOS command inputs to the **CPU**, and contact us for feasibility and cost.

Options 10 & 30: VDC:

Input impedance is 1 Megohm on all VDC ranges. **Accuracy:** $\pm 0.05\%$ of F.S.

FIG. 219-12 ANALOG INPUT SIGNALS
FOR OPTIONS 10-15, 24-28, 30-35, 44 & 45

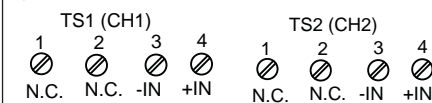

Options 11&31: 1mADC:

Since the **HI-Q219** is 500mV full scale (10,000 Counts) the "Shunt" resistor used is 500 Ohm. Don't forget that maximum display is 9,999 not 10,000! Use option 29 or 49 for other ranges and specify.

Accuracy: $\pm 0.05\%$ of F.S.

Typical Connections: See Option 10.

Option 12 or 32: 4-20mA: It only drops 0.5V @ 20mA (25 Ohms). The "**HI-Q219**" needs ~2W/Bar plus other options to operate.

Typical Connections: See Option 10.

Options 14, 15, 34 & 35: V & mA RMS:

Here we use a **True RMS-DC** Converter for accurate ($\pm 0.05\%$) measurement of sine waves up to 10KHz ($\pm 0.1\%$ for 10-20KHz) and SCRs fired to $\pm 1\%$. Input impedances vs. range are the same as for VDC & mADC ranges. Use #29 or 49 for other ranges and specify.

Typical Connections: See Option 10.

Option 17 & 47: Strain-Gage

(**<1000 Ohm Type**): Here we use high accuracy and stability constant current (~1mA) source, and a differential amplifier to convert the 2 or 3mV/V (typical) sensitivity of your "Loadcell". **Specify** your Strain-Gage sensitivity and full scale and the **HI-Q219's** display at Zero and Full Scale Please! For dual input, use #49 and specify. **Accuracy:** $\pm 0.05\%$ of F.S.

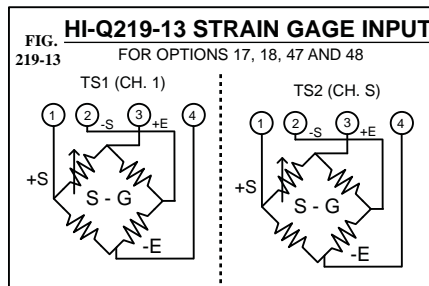

Option 18 & 48: Strain-Gage ($\geq 1K < 4K$ Ohm): These are typically "Monolithic" **S-G** that require constant voltage (preferably) excitation. We use 4.096V for high stability and accuracy. **Specify** your S-G impedance and sensitivity and the **HI-Q219's** display at Zero and Full Scale. For dual input, use #49 and specify.

Accuracy: $\pm 0.1\%$ of F.S.

Note on S-G: Some S-G offer +/-1VDC or 4-20mA conditioned output. Use Option 9 and specify.

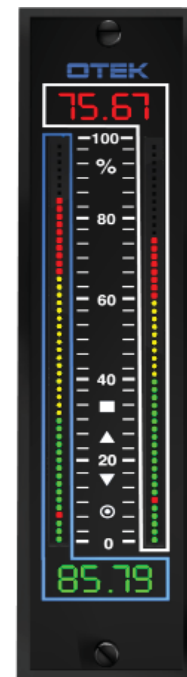
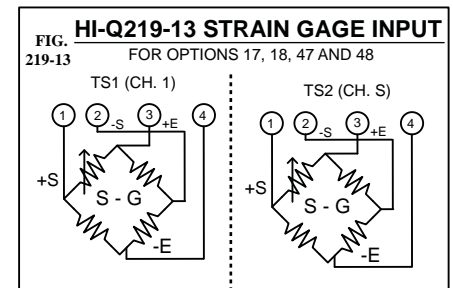

HI-Q219 continued

Option 21 & 41: RTD (PT100):

We excite your 2, 3 or 4 wire RTD with 200µA to avoid the "self heating" effect. The range of the **HI-Q219** is the same as your **RTD** typically -200°C to +800°C (-328 + 1562°F). You can place the decimal point at will (typically -200.0 to 800.0 (-328.0 to 1562.0)). The **PT100** has a temperature coefficient of 0.00385 Ohms/Ohm/°C. (For PT1000 or legacy 0.00392 TC (known as ANSI 392) contact **OTEK** and use Option "29" or "49.")

Note: You can change °C, °F and RTD type (PT100, PT1000, ANSI) via serial port.

Accuracy: ±0.5% of F/C plus sensor's error.

Note: For 2 wire, jump - S to -E and +S to +E. For 3 wire only jump -S to -E.

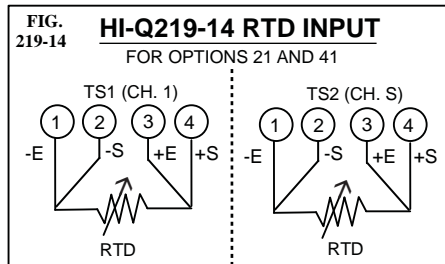

Option 22 & 42: Thermocouple

(Any Type): This **TC** has a range of -210 to + 760°C (-350 + 1390°F). Its color is white (+) and Red (-), cold junction (CJ) is inside the **HI-Q219** at the connector base. Make sure the connections from the **HI-Q219** and your **TC** are as close to the **HI-Q219's** entrance as possible to avoid errors. If you short out the **HI-Q219's** +**TC** & -**TC** together, the **HI-Q219** will read the ambient temperature due to its built-in C.J.C.

Note: You can change °C to F to °K and TC type (any published type) via serial port.

Accuracy: ± 1° F/C of signal input.

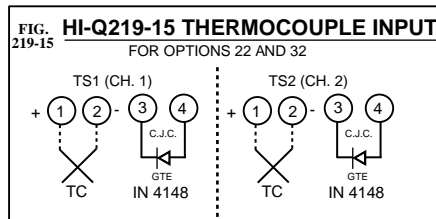

Options 24, 26, 37 & 38: Frequency Input:

We use an **F-V** to accept frequencies from 40 - 20KHz and amplitudes from 1-400V peak or dry contact or open collector transistor (O.C.T.). For 50 to 440 Hz power line frequency measurement. Use Option #24 or 37.

Accuracy: ±0.05% of F.S.

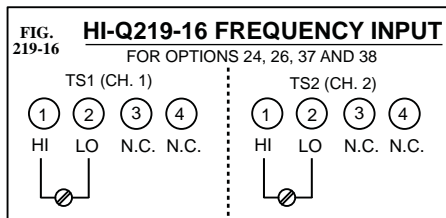

Option 27 & 44: pH (Acidity):

We use a FET input (10¹⁵) amplifier and calibrate the **HI-Q219** for 0-14.00 pH using the Industry's standard ± 413 mV = ± 7pH coefficient.

Note: Not temperature compensated.

Accuracy: ±0.05% of F.S.

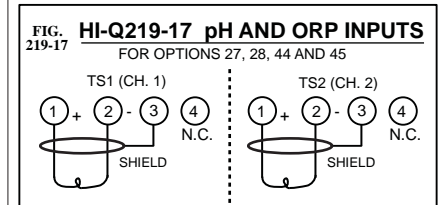

Option 28 & 45: ORP (Oxygen Reduction Potential):

Our FET amplifier (10⁹) accepts the industry standard 2000mV F.S. of the probe and the **HI-Q219** displays it in % (0-100.00%).

Note: Not temperature compensated.

Accuracy: ±0.05% of F.S.

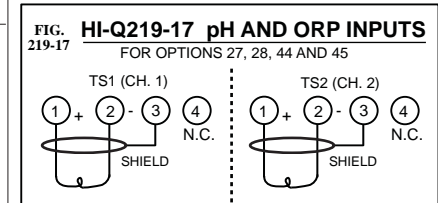

HI-Q219 continued

OTHER OPTIONS NOT LISTED:

1. % RH, Specify your sensor.
2. Very Hi Speed Track & Hold to >50 K Hz.
3. Logarithmic/Anti-Logarithmic
4. Events/Time-Count.
5. Flow/Volume-Speed/Distance
6. To your specifications.

Contact Otek.

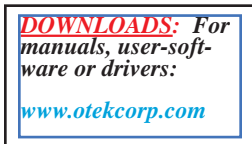

CASE TYPE (DIGIT 9):

Option 4 & 5, Plastic: ABS 94VO black is standard. All options have 2 piece plug-in screw terminal connectors and seismic tested mounting twist tabs (2). Use the optional "trim plates" if your panel has legacy panel cut-out or you're installing several 128's next to each other.

Option 6 & 7, Metal: Aluminum machined, nickel plated (ready for EMI/RFI compliance), black powder coated.

Option 5 & 7, Trim Plates: We include 2 each 0.2" wide trimplates to dress up your panel and cover wider **existing panel** cutout.

Option 9, Custom: Use this to specify your needs. M, N or E options on digit 10 automatically get metal housings (Option 6 or 7).

GRADE (Digit 10): For Industrial use Option I. For M specify Mil-Std. to comply (i.e. 461, 167, 901, 810, etc. For N & E (EPRI) contact Otek.

SCALE PLATE (Digit 11): Specify your custom requirement by using #9. Option 0 is standard 0-100% printing.

RANGE & CALIBRATION (Digit 12): Option 0: IS 0-100% for bar and per input option range 0-FS=0-1000 counts. Use #9 and specify your needs.

HI-Q219 MECHANICAL

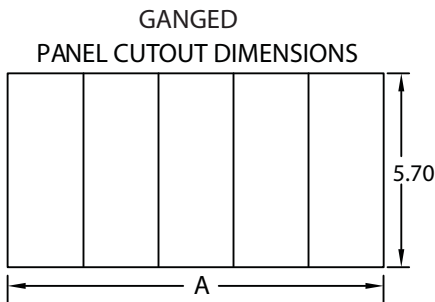

DIMENSION "A"	+0.03 -0.00		+0.76 -0.00	
	# UNITS	INCHES	mm	
1	1.77	44.96		
2	3.52	89.41		
3	5.26	133.60		
4	6.99	177.55		
5	8.73	221.74		

WITHOUT TRIM PLATES

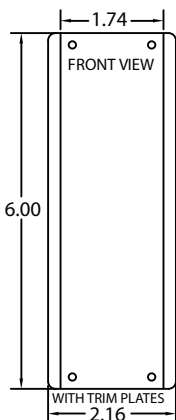

SIDE VIEW

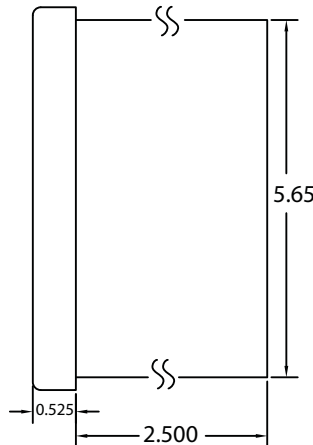

-7-

TYPICAL CONNECTIONS

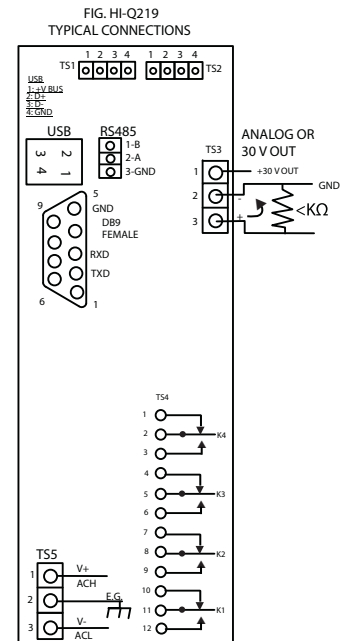

-See users manual at www.otekcorp.com for commands

-See text for connections

520-748-7900
 FAX: 520-790-2808
 E-MAIL: sales@otekcorp.com
<http://www.otekcorp.com>



4016 E. TENNESSEE ST.
 TUCSON, AZ. 85714 U.S.A.



NOTES: Please READ BEFORE building part number:

1. If Digit 10 is option E, Digit 9 must be option E.
2. See notes on bottom of page.

**MODEL
HI-Q219**

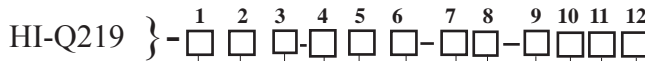

BARGRAPH/DIGITAL/KEYPAD

- 0..... Vertical 1 Each
- 1..... Vertical 2 Each
- 3..... Keypad & Vertical 1 Each
- 4..... Keypad & Vertical 2 Each
- 9..... Custom (Contact OTEK)

BAR-DIGITAL COLOR

- 0 STD. Grn-Yel-Red
- 9..... Custom (Contact OTEK)

SERIAL I/O (3)

- 1..... Isolated 485
- 4..... Isolated USB
- 5..... Isolated RS232C
- 6..... Isolated Ethernet
- 9..... Custom (Contact OTEK)

POWER INPUT

- 0..... 5VDC
- 1..... 10-32VDC
- 2..... 90-265VAC
- 3..... 120-350VDC
- 9..... Custom (Contact OTEK)

CONTROL OUTPUTS

- 0..... None
- 1..... Relays (4)
- 2..... O.C.T. (8)
- 9..... Custom (Contact OTEK)

ANALOG & POWER OUTPUTS (4)

- 0..... None
- 1..... 4-20mA, 1 Each
- 2..... 0-5VDC, 1 Each
- 8..... 30V (30mA Max.) Compliance, 1 Each
- 9..... Custom (Contact OTEK)

RANGE/CALIBRATION

- 0..... Standard (see data sheet)
- 9..... Custom (Contact OTEK)

SCALE PLATE

- 0..... Standard (0-100%)
- 9..... Custom (Contact OTEK)

GRADE (1,8)

- I..... Industrial
- M..... To Mil-Spec
- N..... Nuclear (Contact Otek)
- E..... To EPRI (Contact Otek)

HOUSING DEPTH & MOUNTING (1,7,9)

- 4..... 2" Plastic
- 5..... 2" Plastic w/Trim Plates
- 6..... 2" Metal
- 7..... 2" Metal w/Trim Plates
- E..... Metal 4" for EPRI102323
- 9..... Custom (Contact OTEK)

SIGNAL & DIGITAL INPUTS (5,6,10,11) {2 INPUTS}

- 00..... (Serial Remote Display)
- 09..... Custom (Contact OTEK)

ANALOG INPUTS (1 CHANNEL)

- 10..... 1VDC(1MΩ)
- 11..... 1mADC
- 12..... 4-20mA Current Loop (25Ω)
- 14..... 200VRMS(1MΩ)
- 15..... 1mARMS
- 17..... Strain-Gage (<1KΩ)
- 18..... Strain-Gage (>1K<4KΩ)
- 21..... Temperature RTD (2, 3, or 4 W)
- 22..... Temperature Thermocouple
- 24..... Frequency (47-440 Hz)
- 26..... Frequency (40-20 KHz)
- 27..... pH (Acidity)
- 28..... ORP (0-2000mV)
- 29..... Custom (Contact OTEK)

ANALOG INPUTS (2 CHANNELS)

- 30..... 1VDC(1MΩ)
- 31..... 1mADC
- 32..... 4-20mA Current Loop (25Ω)
- 33..... Watts DC (1M-0.1Ω)
- 34..... 200 VRMS (1MΩ)
- 35..... 1mARMS
- 36..... Watts RMS (1M&0.1Ω)
- 37..... Frequency (47-440 Hz)
- 38..... Frequency (40-20 KHz)
- 41..... Temperature RTD (2, 3 or 4 W)
- 42..... Temperature TC
- 44..... pH (Acidity)
- 45..... ORP (0-2000mV)
- 47..... Strain-Gage (<1K Ω)
- 48..... Strain-Gage (>1K<4K Ω)
- 49..... Custom (Contact OTEK)

NOTES (Continued):

3. Modbus, CAN and others on request.
4. 30V/30mA compliance is for external transmitters/transducers.
5. Volt & Amp ranges are internal selectable. Shipped with 1 V or 1mA F.S. unless specified. If not listed, use #29 or #49 & specify. For "TTL" inputs use #09 and specify.
6. Mixed or additional inputs (V&A, Temp & 4-20mA, etc.) are available as customizations. Choose the custom number (09, 29 or 49) and specify custom requirements.
7. Standard plastic or metal are 2" deep; EPRI/Mil-461 are 4" deep.
8. Otek will build to certain nuclear or MIL-Standards but testing and confirmation of compliance, if required, will need to be done by a third party and at customer's expense.
9. NEMA 4X only with trim plates (Options 5 or 7).
10. Multi-channel input options are factory assigned to specific displays but are field configurable.
11. Digits 7 & 8, Option 00 is for a remote display/controller only.