

NEW

UNIVERSAL DPM/COUNTER-TIMER

Current Loop, Signal or External Powered

Replaces: Any 3" x 6" Barmeter

UPM-5

PATENT
#9,054,721 B1



FEATURES:

- *6 Digits: 9.9.9.9.9.9 (Counter/Remote Display) or -1.9.9.9 (DPM)
- * INPT FAIL Alarm with Run Time Stamp
- *Self Diagnostics
- *Isolated Serial I/O: USB/RS485
- *Ethernet/Modbus on Request.
- *Only 100mW@5VDC or Powerless™
- *Intensity Control Via Serial Port
- * Math functions (+, -, x, √, ÷, X-Y tables, polynomials)
- *Averaging: None to 255
- *Alpha Characters Selectable
- *Power Input Options: 5, 7-32VDC & 90-265VAC
- (External Powered Models Only)**
- * >30 Isolated Input Signals
- *4 Relays or Isolated Transistors
- *4-20mA/30V Output
- *Ethernet
- *µSD Flash Memory: 32 GB
- *Lifetime Warranty

SECTIONS:

- DPM: Pages 2-8
- COUNTER: Pages 8-14
- REMOTE DISPLAY: Page 14
- ORDERING INFORMATION: Pages 15 - 17



DESCRIPTION: The **Universal Panel Meter (UPM)** series combines over 40 years of experience with the latest ASIC uC and ultra-efficient multi-color LED technology to bring you into the 21st century. The **UPM** external power series features over 30 signal conditioners to replace form, fit and function any analog or digital input panel meter. If not, we'll make it!

Our patented hardware and firmware gives you the highest reliability (we have a lifetime warranty) at the lowest cost, with features such as: automatic (programmable) tricolor display (like a traffic light); automatic signal fail detect (open or short); indication and serial transmission with run time stamp and units ID, relays, isolated retransmission (4-20mA), and universal power inputs (5-32VDC or 90-265VAC). The **UPM** Series offers several math functions such as X-Y tables, polynomials and log-anti-log functions.

The **UPM** signal and external power series also feature isolated USB, RS485 or ethernet, open collector transistors (4/channel) and SPDT relays (4/channel). You can tell us your custom needs and we'll make it (or might already have it)!

The **UPM-5** is available in either a loop (4-20mA), A.C. or D.C. signal or external power version. The external powered versions can accommodate 4 relays, isolated DAC and power for the analog output (per channel), include >30 signal conditioners and isolated input power options, as well as ethernet and flash memory (µSD). Standard factory set color changes are: red: <10, >90%, yellow: <20, >80%, green: >20, <80% of F.S. Use digit 14, option 9 for custom configuration (you can change it with simple commands).

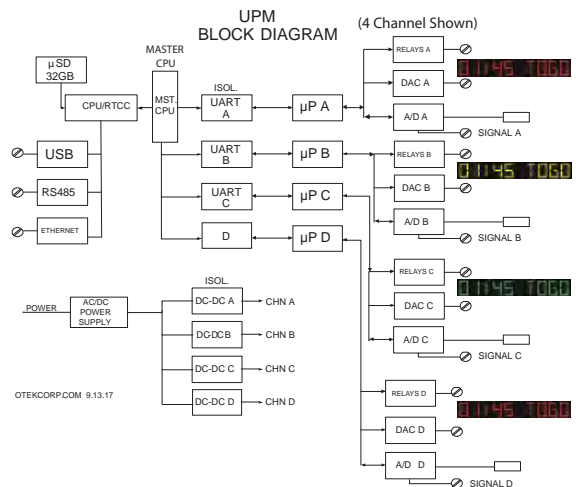

520-748-7900
FAX: 520-790-2808
E-MAIL:sales@otekcorp.com
http://www.otekcorp.com

OTTEK™
CORP.
SINCE 1974

4016 E. TENNESSEE ST.
TUCSON, AZ. 85714 U.S.A.

MADE
IN
USA



WHAT CAN YOU DO WITH OTEK'S NEW UPM/DPM FUNCTION?

All models share the same award winning software and hardware (patent #9,054,721 B1). This allows you to implement the following applications, restricted only by the hardware limitation of each model and your imagination. **Note:** contact us about **Otek's Powerless™ Technology:** If your signal cannot supply $\geq 10\text{mW}$ ($\sim 3\text{V}/3\text{mA}$), use an external power model. See pages 8-14 for UPM-Counter functions and Page 14 for remote display/controller.

1. One Channel Only Models:

-0, -F, -L, -R & -X: Implement any math function, X-Y table (25 point), polynomials (9th order), offset, zero, scale, tare, log & anti-logarithmic to affect the unit's display at will. Some examples are: change the display & data using any combination as commanded by your algorithm, such as $+/-/X/\div/\sqrt{\quad}$ or set a variable or linearize the display using X-Y tables or polynomials. This works well for odd shape containers. You can also change the reading from °F to °C or °K or compress/expand the display (and data out) using the log and antilog functions. In addition, you can change the factory default alarm set points and colors or delete them. Zero & Span potentiometers **are included** for manual adjustment (best via serial).

2. Multi-Channel Model:

-3, -4, -5, -A, & -H Features include all those of the single channel models, each channel μC is 100% isolated from each other. In addition, you can add, subtract, multiply, divide, find the square root between channels. You can also use one channel to monitor/control the input signal and the second channel to indicate deviation, differential such as **PID**, alarm override or one channel setpoint can be used to control another channel function. One channel may also function as a backup if the other channel becomes disabled or use them as volume & flow ($\sqrt{\quad}$) monitors/controllers. The **New Technology** two channel model is also perfect as a REM/RAD indicator/controller (also see our RPM series with log-antilog functions for radiation monitoring).

Contact OTEK for algorithms and formulas or any idea you wish to share with our audiences via our Youtube or Facebook page posts.

3. Three Channel Models: -3,

-4 and -A: Note: Also available on 4 channel model (-5). Otek's New Technology three channel models perform all the functions outlined in #1 and #2. Further, one channel can indicate the input variable and the other two channels can be setpoint indicators/controllers (Hi, Hi-Hi, Low and Low-Low limits), or subject the input/output to any mathematical function or algorithm such as **PID** or display the input vs. output and derivative, or switch scales when the input reaches a limit/band such as for flow-volume-pressure or temperature. Monitor Volts, Amps and Watts AC or DC or any of 3 variables, including Hertz, lead/lag, power factor, peak/valley or cost by adding a KW cost multiplier.

The **TPM** series brings **Process Automation Control** (PAC) within your reach and affordability. These models are compatible with any DCS/SCADA system using their USB/RS485/Ethernet I/O options and allow for ease of interface with wireless systems.

4. Four Channel Model:

-5: The four channel model offers all of the functions outlined in #1, #2 and #3. However, with the additional channel available, the **UPMs** rival flatscreens with superior HMI/MMI functionality and ease of viewing/analysis of any combination of 4 variables. For example, Volts/Amps/Watts/Hertz or temperature/pressure/pH/humidity. The four channel model can also be used to monitor/control the product of the other 3 variables, making it ideal for the petrochemical industry.

The UPM offers Data Logging. Some models offer optional μSD memory to record 24/7 anything available via the serial I/O. Maximum capacity is 32 GB!

NEED REDUNDANT CONTROL?

Since all channels are 100% isolated from each other and the CPU can communicate with any and all MCPUs, you can use the multi-channel **UPM** for redundancy control. Also see our model **TRC** (Triple Redundant Controller) that has all you need for the utmost in safety control.

Build Your Own Part Number or Receive a Quote online at:

<http://www.otekcorp.com/configurator/nts/>

CLASS 1E
10CFR50 APP. B
MIL-SPEC &
INDUSTRIAL
GRADES



**IF YOU DON'T
SEE IT
ASK FOR IT!**

**Millions of possible combinations in seconds!
How? Use our award winning part number configurator for NTM & UPM:**

1. Compare models
2. Build a specific part number
3. Get instant pricing
4. Build a customized user's manual



Description & Notes

DIGIT 5, SERIAL I/O & MEMORY:

Settings: 8N1N, 1200-19,200 Baud, ASCII.

Digit 5, Serial I/O: Option 0, USB: Complies 100% with V2.0 and if digit **10**, option **1** is selected (USB powered) then digit **5** must be option **0**.

Note on USB Connectors: All models with Digit 5, Option 0 have a standard **type "B"** on the back. **M & E** grades might require "filter" connectors on back and must be specified. Use Digit 5, Option 9 and contact OTEK for **cyber security** compliance to NEI 08-09 & other regulations.

Digit 5, Option 1, RS485: Complies with industry standard. A terminating <1K Ohm resistor at first and last unit in the BUS.

Digit 5, Option 2 Ethernet: Complies with 1- Base-T/100Base-TX RJ45 up to 19,200 Baud. Maximum power consumption is <300mA@5V (1.5W). Only available in selected models. Connector: RJ45 on back.

Digit 5, Options 3 & 4: μ SD Flash Memory: μ SD flash memory with up to 32 gigabytes capacity. You can store selected data at-will (i.e. when limits trip) via serial command and download or remove it as required.

Security: Password protected access to the **UPM's** HW and software. Complies with NEI 08-09 cyber security mandates. **Front Panel Controls:** None for added security and safety. Nuclear and MIL-Spec version comply with NEI 08-09 and/or 10CFR50, 10CFR59 and 10CFR 73.54 on request.

DIGIT 6, GRADE:

Industrial Grade (Options 0 or I) is per these published specifications. Grades **M** and **E** per agreed specifications. Options **E & M** typically include an EMI/RFI shield all around and filtered connectors to meet EPRI-TR-102323-R3 (requiring ~2" deeper case). OTEK will build to certain nuclear or MIL-Standards but testing and confirmation of compliance, if required, will be quoted as a separate line item.

DIGIT 6, GRADE: (CONTINUED)

Option **0** is 94VO plastic, option "**I**" is an aluminium nickel plated case and cover; bezel face has black powder coat finish to Mil-Specs. The back cover is either black plastic or nickel plated aluminum. Typical Mil-Specs: 461, 462, 169, 901, 801, RTCA-160, I EEE344, etc. Contact Otek for custom colors.

NTM-X: Certified for Class I, Div. 1, Groups B-G; EX & IECex: IM2, Exd1.

DIGIT 7, (# CHANNELS):

The **UPM-5** offers 4 channels, 6 characters each, 0.6" high tri-color.

DIGITS 8 & 9 (INPUT SIGNAL): SECTION A: See Input Signal Conditioners section (pages 6-8) for description and specifications.

DIGIT 10 (POWER INPUT):

Digit 10, Option 0, Powerless, No Power Required: The **Input Fail** detect/Alarm (patented) flashes the display "INPT FAIL" (**INPT FAIL**) and transmits this serial message for ~20 seconds, after which it will cease. This feature is available in all models and its trip point can also be programmed by the user. If **NOT** desired, use option **9** on Digit **10** and specify (see below). Signal Fail Requirement: Unit must be "On" for at least 1 minute at >50% of full scale for it to operate. You can change the message via commands.

Digit 10, Option 1, USB Powered: Back up Power for signal powered models: Some applications might require "keep alive" power in case the input signal fails in Powerless™ models (signal/loop powered). If you select option **1** on Digit **10** and have a **USB** connection, the **UPM** will transmit the distress message "INPT FAIL" until the signal is restored or the **USB** is disconnected. The VBus drives a DC-DC converter to preserve the isolation from signals and the USB. ~20mA is required from the USB.

If you don't use **USB** and need "keep alive" power, select options **2-4** or **9** on digit **10**. The **UPM** "keep alive" power requirement is <3mA@5VDC.



DIGIT 10 (POWER INPUT): {Continued}

Digit 10, Option 2, Isolated 5VDC: 5VDC is also used to drive the relays (<100mA total) and/or the DAC via internal isolated 5-30VDC-DC (<200mA). If you order relays and analog out, you will need ~300mA/channel. This option is also isolated from the input signal.

Digit 10, Option 3, Isolated 7-32VDC: Same as option 2 but with wide input range of 7-32VDC. Efficiency: >80%.

Digit 10, Option 4, Isolated 90-265VAC: This option accepts 50-60Hz. For 100-300VDC or 400 Hz, use Digit 10, option 9 and specify. Efficiency: >80%.

DIGIT 11 (CONTROL OUTPUTS) & DISPLAY COLORS:

Digit 11, Control Outputs: Options 1, 3, 5 or 7: Open Collector Transistors (O.C.T.): They are **NOT** isolated from each other (common emitter) but are **isolated** between channels and can sink a maximum of 30 mA and sustain a maximum of 30V_{CE}. When you order relays (Digit 11, options 2, 4, 6 or 8) we use the O.C.T. to drive the relays on "powered" models. 5VDC is available to drive your loads. Max total current: 50mA. O.C.T. are ideal to drive S.S.R. for high speed switching. Power required: None.

Digit 11, Options 2, 4, 6 or 8: Relays: are S.P.S.T. (1C) and can switch maximum **resistive** loads of 1 Amp @ 120 VAC or 30 VDC. They include 300V varistors at their contacts. Power required: 250mW@5VDC/relay.

AUTOMATIC DISPLAY COLORS:

Limits/Colors Factory Default (% of Full Scale): Also see digit 14, Range/Calibration.

Low-Low Limit (<10%): Red Display, OCT1/K1 & OCT2/K2 "ON"

Low Limit (<20%): Yellow Display, OCT2/K2 "ON"

High Limit (>80%): Yellow Display OCT3 & K3 "ON"

Hi-Hi Limit (>90%): Red Display, OCT4/K4 & OCT3/K3 "ON"

Safe Area (>20<80%): Green will follow signal input and if outside the limits, it will change its color to the limit's color (yellow or red).

For other custom configurations, use option 9 on Digit 14 (field configurable). Max power consumption per relay: 50mA@5VDC (0.25W). See Digit 14.

DIGIT 11 (CONTROL OUTPUTS) & DISPLAY COLORS: {Continued}

Digit 11, Options 2, 4, 6 or 8: Relays (Continued)

External Control: You can control the O.C.T./Relays via the serial port with simple commands. They don't have to be assigned to the display colors/set points, but are by default.

Notes:

1. Digit 11 is governed by Digit 7 (# of Channels) & Digit 4 (Housing).

Fail Safe: O.C.T. and relays are normally "Off" by factory default. For "Fail Safe" mode, you can program them in the field or use option 9 (Custom) on Digit 11 when ordering and specify "**Relays (or O.C.T.) normally on.**"

DIGIT 12 (ANALOG /POWER OUTPUT):

Digit 12, Analog Output, Options 1, 3, 5 or 7: This isolated output is factory set to follow the input (0-F.S. in=4-20mA out) but can also be set for other outputs or it can be serially controlled by simple commands via the serial port. For other outputs, use option 9 and specify, including reverse scale (0-FS=20-4), bipolar and **PID**. Power consumption: 200mA@5VDC (1W)/channel.

Analog Output External Control (Use Option 9 and specify):

A) 0-100mVDC in=4-20mA out; B) 0-10K Ohm in=4-20mA out; C) Use options 58, 68, 78 or 88 and control it via serial port exclusively (**no** input signal).

Digit 12, 30 VDC Out, Options 2, 4, 6 or 8: Use this option to power your 4-20mA transmitter or other transducer. Maximum current is 25mADC. It is isolated and is the same power source we use for options 1, 3, 5 and 7. Power consumption: 200mA@5VDC (1W)/channel.

Notes:

1. Digits 11 & 12 are governed by digits 4 (Housing) & 7 (# of Channels). Reason: Digit 11 & 12 cannot have more outputs than input channels (but it can have none), which is governed by Digit 4 (Housings).

DIGIT 13 (SCALE PLATE):

Digit 13, Scale Plate: Option 0 is a standard scale plate with no text. Use option 9 for custom printing and contact Otek.



DIGIT 14 (RANGE/CALIBRATION):

Option **0**= Factory Default = 0-Full Scale=0.0-100.0 digits.
 Colors: <10>90%: Red; <20>80%: Yellow; >20<80%: Green. For custom colors, use Option **9** (custom) and contact Otek. Also see Control Outputs (Digit 11). You can program it for other values, none or via the serial port. Default messages: **INPUT FAIL**, **LLAL**, **LALM**, **HHAL** and **HALM**.

ABOUT OUR INPUT FAIL DETECTION

Only available on Powerless™ models (8th & 9th digits, options 00-18). While in normal operation, we store excess energy and use it to power the **UPM** if and when the signal fails (post mortem).



OTHER IMPORTANT DATA:

Math Functions: +, -, x, ÷, √, Log/Anti-Log, Polynomials to 9th order, 25 Point X-Y table, zero, offset, span and tare. You can add, subtract, multiply, divide (etc.) one channel to/from another channel and display the result in the other channel (i.e. V (Ch.1) xA(Ch.2)=W(Ch.3). We do it for Watts on options 12, 13, 14, 70-75 and 80-83.

PID: Programmable (best with 2 or more channel models) automatic or manual with external 10K Ohm potentiometer (option **56**). See models our **NT Series** for dedicated 4-20mA transmitters (same technology).

Industrial Grade Common Electrical Specifications

(See Pages 8-14 for Counters & Page 14 for Remote Display/Controller)

SECTION A: DPM

Input & Display: See Next Page For Input Signals:

Note 1: E and M grade electrical specifications are the same as Industrial unless otherwise specified.

Note 2: OTEK reserves the right to change specifications without prior notice to improve the performance of its products.

- * A/D: Accuracy, Linearity & Resolution: +/- 0.5% of F.S., ±1 LSD. Conversion Rate: 40/sec, Averaging: 0-255, zero, span, offset, tare and math functions.
- * Digits: Four Full Active Digits (9.9.9.9 & -1.9.9.9); 0.6" High, Alphanumeric Auto-Tricolor (R/Y/G), 15 segments
- * Typical Power Consumption of Display: 10-100mW@3.3V-5V; \loop/signal power version best at > 8mA.
- * Temperature Coefficient: +/-50PPM/°C
- * Operating Temperature: -10 to +60; Storage: -20 to +70°C
- * CCMR: >90dB@50-60Hz
- * Isolation: >500VDC to any other I/O & P.S.
- * Humidity: 5-95% RH non-condensing
- * Front Panel: NEMA 3. NEMA 4X on request.
- * Failed Signal Detect: ~ **20** seconds after > **1** minute @**50%** of F.S. Only on loop & signal powered models.

Note 3: See the master catalog for environmental specs vs. housing.

SAME HOUSINGS, DIFFERENT FUNCTIONS



The **NTM (New Technology Meter)**: The same patented technology for analog input only. All else is the same as the UPM, but has an automatic tricolor bargraph for trend indication.



The **NTT (New Technology Transmitter)**: Since the NTM & UPM have 4-20mA outputs, they are transmitters. So, we build them specifically for 4-20mA transmission, change the housing for DIN-Rail or panel mount or explosion proof and you're the winner. No NRE, NO R&D! What's next? **TPM?** **SSAM?**

Build Your Own Part
 Number/User's Manual
 or Receive a Quote
 Online at:
[http://www.otekcorp.com/
 configurator/upm/](http://www.otekcorp.com/configurator/upm/)



The Powerful Powerless™

Yes! You can have the **UPM** (DPM mode only) powered by the input signal and have controlling outputs such as relays, O.C.T. & analog output!

How it works: Your input signal (Digit 8 & 9, options 00-18 only) powers the display, CPU, serial I/O and isolators. Your external power source powers the outputs (if included).

Benefit: You have two independent and isolated sources (fail safe).

Requirement: Your signal must produce >10mW (current loop, VDC, VAC or AAC) and sustain <4V burden. If not, use external power (options 20-85 on Digits 8 & 9).

AC Signal Power & Outputs? Yes, you can have both input options 01-18 (digits 8 & 9) and relays (2 maximum) without external power!

Requirements: VAC input must be >90<140VAC, and AAC input must be >1.5<4 AAC via C.T. Ideal to monitor and control 120VAC mains! Contact OTEK for details.

Important Note on A.C. Powerless

The **NTM, UPM & NT** Series can extract energy from your A.C. signal to power itself and opto isolated serial, optional O.C.T. (Digit 11, options 1, 3, 5 or 7), and to power the optional 4-20mA output (not 20-4mA out) from a wide input range (see specifications on pages 6-8). External power is required to power the optional relays (Digit 11, options 2, 4, 6 & 8) (200mW each). If you need relays, either use the external powered options on Digits 8 & 9 (33, 37, 40 or 42) and Digit 10 power input options (1-4) or use Powerless™ options 01-04 on Digits 8 & 9 and Power Input option 09 (custom) on Digit 10 and specify (09=Power for relays and DAC). Result: The signal will power the instrument and will include our patented **Signal Fail Detection & Alarm**. The relays and analog output are powered by the external power option (all 100% isolated).

INPUT SIGNALS (Digits 8 & 9):

Note: Otek's exclusive Input Fail detect (open or short) is standard on all inputs. Use option 29 and specify if you want it disabled (also field configurable).

SECTION A: DPM INPUT SIGNAL SPECIFICATIONS (Digits 8 & 9)

INPUT SIGNALS (Digits 8 & 9):

Note: Actual connection will vary. See the User's Manual for specific connection information.

Note: All ± 1 LSD and % full scale range unless noted. Also see Note 1 in "Section A: DPM".

Options 00 & 17 For Loop Power Only:

Option 00, Loop Powered: Burden: < 4V; Range: 3-26mA; Accuracy & Linearity: $\pm 0.5\%$ of F.S., ± 1 LSD.

Option 17, Loop Powered: Burden: < 4V; Range: 9-55mA DC; Accuracy & Linearity: $\pm 0.1\%$ of F.S., ± 1 LSD.

Options 01 through 14 for A.C. Signal Powered Only

FUSE IT! Use external 1/2 ASB for Volts and 7 ASB for Amps.

Note: C.T. (Current Transformer) are sensitive and limited to the secondary (output) impedance. OTEK A.C. signal powered products present and input impedance of ~ 0.2 Ohms ($\sim 1V@5A$). Make sure your C.T. can drive a >0.3 Ohm load without saturating or losing linearity. Contact Otek for assistance. Best C.T. to use: >100:5.

Note: All inputs for 50-60 Hz lines. Contact Otek for 400 Hz lines.

Option 01, VAC P.T. (Potential Transformer): Burden: 0.2 Ohm & <100mW; Range: 30-140V/40-100Hz; Accuracy & Linearity: $\pm 0.5\%$ of F.S. Best operating range 90-140VAC to specifications.

Option 02, 5 AMP A.C. (C.T.): Burden: 0.2 Ohm & <100mW; Range: .5-5A; Accuracy & Linearity: $\pm 0.5\%$ of F.S. Best range 2-4 Amps.

Option 03, Watts A.C. (C.T. & P.T.): Range: >100<600W/50-60Hz; Accuracy & Linearity: $\pm 0.5\%$ of F.S. at 90-140VAC & 1-4AAC. Best operating range: 100-500 Watts. For 400 Hz lines, use option 09 and specify (09=400 Hz line) after the complete part number.

Option 04, Hertz VAC: Range: >30V<140V & >30<100Hz; Accuracy & Linearity: $\pm 0.5\%$ of F.S. For 400 Hz lines, use option 09 and specify (09=400 Hz line) after the complete part number.



VAC/DC Signal Power Only: Options 16 & 18

Option 16, 7-130VDC: Now you can monitor and control your DC line, UPS, battery bank or power supply from 7-130VDC with only power from the signal. The **UPM** requires $>10<80\text{mW}$ ($\sim 3\text{mA}-20\text{mA}$). Imagine the possibilities! Almost like analog (only signal wires), but with 21st century digital technology ready for your PAC/DCS/SCADA system.

Scaling: 7-130VDC in = 7.0-130.0 Digital Display & 5-100% bar-graph with alarm pointers. See Digits 13 & 14 for custom calibration and scale.

Accuracy & Linearity: $\pm 0.1\%$ of full scale.

Option 18: 10-500mADC Signal Power: Calibration: 10-500mADC=10-500 & 5-100%. For other calibrations, use digit 14, option 9 and specify.

Alarm Outputs (Signal Power): Open collector transistors (4) optional. See the ordering information on pages 15-17, digit 11, option 1. For relays, contact Otek (custom). Requires external 12-24 VDC.

Options 20 through 58: For Externally Powered Only:

All input channels have the same specifications unless noted. See options 60-89 for mixed signals.

Option 20, 4-20mA: Burden: $<25\ \Omega$ (0.5V); Range: 3-26mA; Accuracy & Linearity: $\pm 0.5\%$ of F.S.

Options 21 through 24, VDC: Input impedance 1M Ω ; Range: Per Option; Accuracy & Linearity: $\pm 0.5\%$ of F.S.

Options 25 & 26, mADC: Input impedance Option 25: 50 Ω ; Option 26: 5 Ω ; Accuracy & Linearity: $\pm 0.5\%$ of F.S.

Option 27, Watts DC (1Vx1A DC): VZin: 1M Ω /AZin: 1.0 Ω , 5W; Range: 1W; Accuracy & Linearity: $\pm 0.5\%$ of F.S.

Option 28, Watts DC (1Vx1V): VZin: 1M for both inputs; Range: 0-1V; Accuracy & Linearity: $\pm 0.5\%$ of F.S.

NOTE: Always use **P.T.** or **C.T.** with H.V. Lines (Options 30-34).

Options 30 through 34: VRMS: Zin: 1M Ω ; Range; per options; Accuracy & Linearity: $\pm 0.5\%$ of F.S.

Options 20 through 58: For Externally Powered Only
(Continued)

Options 35-37, Amps RMS: Zin: Option 35: 2 Ω ; Option 36: 0.2 Ω ; Option 37: 0.04 Ω ; Range: Per option; Accuracy & Linearity: $\pm 0.5\%$ of F.S.

Option 38: Watts RMS (1Vx1V AC/DC): Zin: 1M Ω for both inputs; Range: 1V RMS; Accuracy & Linearity: $\pm 0.5\%$ of F.S.

Option 40, Watts RMS (120VAC P.T. x5AAC C.T.): Zin: 1M for V & 0.04 Ω for A; Range: 0-750W; Accuracy & Linearity: $\pm 0.5\%$ of F.S. Note: Shunt resistor (0.04 Ω) supplied.

Option 41, Frequency (10KHz/5V Logic): Zin: 1M; Range: 30-10KHz; Accuracy & Linearity: $\pm 0.5\%$ of F.S.

Option 42, Hertz (120V, 40-100Hz): Zin: 1M; Range: 50-150V/40-100Hz; Accuracy & Linearity: $\pm 0.5\%$ of F.S.

Option 43, Hertz (240V, 30-100Hz): Zin 1 M; Range: 100-260V/30-100Hz; Accuracy & Linearity: $\pm 0.5\%$ of F.S.

Option 44, Hertz (120V, 500 Hz): Available on a Powerless (90-140VAC/370-420 Hz) or external powered unit. For external power, just use option 44 on Digits 8 & 9 and specify. On the Powerless model, use option 09 (Custom) on Digit 8 & 9 and specify Option #44. (requires >1 watt from input signal). For 240 VAC/400 Hz, use option 29 & specify.

Zin: 1 M; Range: 50-150V/300-500Hz; Accuracy & Linearity: $\pm 0.5\%$ of F.S.

Note on Strain Gages: Specify impedance, sensitivity, range and calibration. Example: 350 Ohms, 2mV/V, 10mV=0-100.0%.

Option 45, Strain Gage (<1K Ω): Excitation: 4V; Range: 300-1K Ω ; Accuracy & Linearity: $\pm 0.5\%$ of F.S.

Option 46, Strain Gage (>1K Ω): Excitation: 4V; Range: 1K-5K Ω ; Accuracy & Linearity: $\pm 0.5\%$ of F.S.

Option 47 & 48, RTD: 47: 100 Ω (PT100); **48:** 1K Ω (PT1000); Range: same as RTD; Excitation: 0.5mA; Accuracy & Linearity: $\pm 0.5\%$ of F.S. 2, 3 or 4 wire RTD. For 3 wire, connect -E to -S. For 2 wire, also connect +E to +S. Warning: Max distance to sensor: ~ 300 Feet (100 M) or use our **NT** transmitters.

Note for Options 47-52: You can switch from $^{\circ}\text{F}$ to $^{\circ}\text{C}$ via serial port or use option 29 and specify. Default: $^{\circ}\text{F}$ (uses internal linearized table).



Options 20 through 58: For Externally Powered Only:

Option 50, Type "J" TC: Range: -210 to 760°C; Colors: red and white; CJC: Included; Accuracy & Linearity: $\pm 2^\circ\text{C}$ of F.S.

Option 51, Type "K" TC: Range: -270 to 1370°C; Colors: Yellow and red; CJC: Included; Accuracy & Linearity: $\pm 2^\circ\text{C}$ of F.S.

Option 52, Type "T" TC: Range: -270 to 400°C; Colors: blue and red; CJC: Included; Accuracy & Linearity: $\pm 2^\circ\text{C}$ of F.S.

Note for Thermocouples (TC): Shorting out the +/-TC input terminals will display the ambient temperature of the C.J.C. at the input terminals.

Option 53, pH: Range: 0-14.00; Z_{in} : $>10^{15}\Omega$; Temperature compensation: None; Accuracy & Linearity: $\pm 0.5\%$ of F.S.

Option 54, ORP: Range: 0-2000mV; Z_{in} : $>10^9\Omega$; Accuracy & Linearity: $\pm 0.5\%$ of F.S.

Option 55, % RH: Range: Per sensor; Input Type: 2-3 pF Capacitance; Accuracy & Linearity: $\pm 0.5\%$ of F.S. State sensor's specifications.

Option 57, 10-50mA Range: 10 Ohms input resistance Accuracy & Linearity: $\pm 0.5\%$ of F.S. ± 1 Digit.

Option 56, Resistance Range: 0-10K Ω =0-100%=0-100.0; Accuracy & Linearity: $\pm 0.5\%$ of F.S.

Option 58, None: Serial input only as per Digit 5 for remote/display controller.

Options 60-89:

For multichannel mixed signals. Same specifications as per options 20 through 56.

SECTION B: COUNTERS

B) THE UNIVERSAL COUNTER/TIMER CLOCK (Digit 15, Options 1-9 and A-L):

The **UPM** can function as a **universal counter**: It accepts digital inputs to perform over 20 functions, all of which can be selected by serial input commands.

Functions: Batch – Debouncer – Draw – Frequency – Integrations – Julian Clock (RTC) – Log/Anti-Log Extractor – Period – Phase Angle – Positioning – Quadrature – Range – Rate (1/F) – Ratio– Square Root – Stopwatch – Time Interval – Totalizer – Up/Down Counter – Up/Down Timed (Milliseconds to years!).

Features: Fully configurable for any listed function via serial port.

* Same features as **DPM** section except it is only offered in external power (Digit 10, options 1-4).

* Same features as **NTM** series except it has an Alpha-Numeric Tricolor Display instead of a bargraph.

* Multiple isolated displays (up to four) allow for complex math functions/display/control of process variables such as Volts/ Amps/Watts/Frequency/Pressure/Flow/Volume and temperature, and PID or **redundant control**.

* Three angle positioning (X, Y, Z).

* Intelligent (HMI) moving messaging (up to 18 characters).

* Automatic process control (MMI) and much more.

Input and Output Terminals and How To Use Them:

Note: Not to be confused with input signals for measurement.

Besides the regular input signal terminals, the **UPM** has other external terminals to control its functionality. These functions can be enabled via serial command or managed by the internal function selected. Refer to customized user's manual.

Terminals that are already dedicated and controlled externally have a 5K pull up to the isolated 5VDC of its channel and only accept 5V logic levels or dry contacts.



Input and Output Terminals and How To Use Them Continued):

Borrow (only in the first stage of a string): Connect "Borrow" pin to "Carry" pin of previous unit (or channel) to expand the number of channels.

Carry (only in the last stage of a string): Connect "Carry" pin from the first unit to the "Borrow" pin of the next unit (or channel) to expand the number of characters.

Count Hold (Digit 15, Options 5, K, L): "Grounding" this pin (5K pull up) forces the counter to stop counting.

Display Hold (Digit 15-, Options F, K): "Grounding" this pin (5K pull up) holds the display, but allows the counter to continue counting.

Frequency out (Digit 15, Options 5, F, K): This pin is the F out of the signal conditioner after it has been converted to 5V logic levels. Minimum load=1K Ohm. Useful for F-V.

Run/Stop (Digit 15, Option G): This pin is functionally the same as "Counter Hold" except has a $<1\mu\text{S}$ response time.

Frequency Response (No De-Bouncer): Useful for DCS/SCADA/PAC interface, $<1\mu\text{S}$ response time.

Reset (Digit 15, Option 5): This pin is used to reset the internal accumulated count and has no De-Bouncer since its used in "Frequency" counter (up/down) modes. Response time: $<1\mu\text{S}$.

Up/Down (Digit 15, Option 3): Leave this pin open for "UP" count or "ground" it for "DOWN" count. If connected to an encoder, connect "UP" into "A" and "DOWN" into "B" and "RESET" to "Z" for rotary zero detect encoders.

Inputs/Functions (Digits 8 & 9 and 15): Conditions: If digits 8 & 9 have options 00 through 58, 60-68, 70-78 or 80-88, then digit 15 must be option "0 (None)."

Input and Output Terminals and How To Use Them Continued):

Up/Down Counter (Option 1): (also see "Quadrature" counter) A counter is a totalizer that can be enabled/disabled by several means such as an input (gate), a command (serial), or a result of another action produced by your algorithm, such as $\text{CHA} + \text{CHB} / \text{CHC} = 0$. Therefore, start/stop counts or times on CHD, which can be useful to synchronize 3 phase power lines or radiation counters. If you use the F-V option, you can convert analog signals to digital format for higher accuracy synchronizing. Imagine the possibilities limited by your algorithm!

UPM FIG 1: u/DC, Option 1

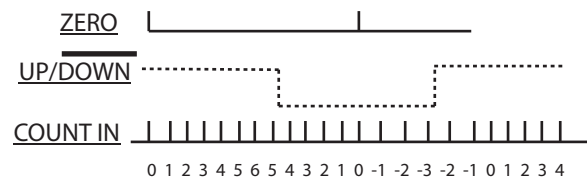

Totalizer (Counter) (Options 2 & 1A-4C): This function accumulates the number of pulses received on Input A after Input B has been taken high (\uparrow), will sum the events for as long as Input B remains high and will decrement on the falling edge (\downarrow) of Input B. You can switch the logic of Inputs A and B via simple commands and by using the command "TOTDN" (totalizer down) instead of "TOTUP" (totalizer up), you can enable any controlling output/message (relay, O.C.T., DAC, color change, message, etc.).

Multiplier: (also see "Divider") In some applications the input data needs to be multiplied to arrive at unity count such as tanker to barrels, barrels to gallons, gallons to liter, etc. Select the appropriate multiplier of your choice with up to four decimals (xxxx.yyyy).

Divider: (also see "Multiplier"): Some applications require counting in multiples of units such as dozens/bag, gallons/barrel, liters/cask, etc. Just select the divider number and count in desired unit of measurement (1/2, 1/56, 1/500, etc.).



SECTION B: COUNTERS (Continued)

Quadrature (Option 3): (also see "Datum Zero") This function includes inputs for Input A (count), Input B (direction), and Input Z (datum zero). When Input A rising edge (\uparrow) leads Input B rising edge, the **UPM** will increment its count by one (1). When Input B leads Input A, it will decrement its count by one (1). Regardless of Logic state of Inputs A or B, when Input Z transitions from Logic 0 to 1, the **UPM** will reset to zero. This is important when using rotary encoders to indicate the zero degree point. Again, the resolution of the measurement is determined by the number of pulses/rotation of your encoder and the multiplier you select. But you can display/control the process in decimal or clock (360°:60M:60S) format. Linear encoder is used for length measurements/control, rotational encoders for rotational (degrees) applications. The automatic tricolor change will warn the operator of anomalies.

The **UPM** can be forced to zero count via a serial command or an OR connection at the Z Input since it has a 10K Ω pull up to 5V (high to reset to zero, low to run). The Z (zero) pulse should be as short as possible (>1 μ S) to avoid missing a count.

UPM FIG 3: Quad A, Option 3

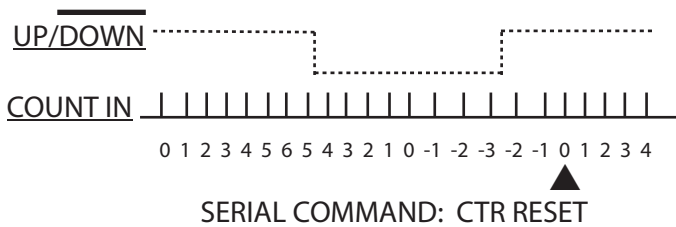

3.1 Zero Datum: (also see "Quadrature" and "Up/Down" Counter) This single pulse/revolution is produced by rotary encoders to indicate 0° and it is used by the **UPM** to zero its display and start counting up or down in a degree fashion with degrees, minutes, second, and milliseconds of rotation determined by the resolution of your encoder. For linear measurements, use command "LIN." For rotational, use the command "ROT."

UPM FIG 3.1: Quad B, Option 3

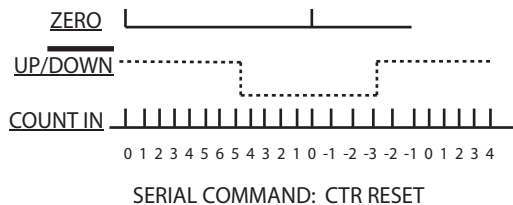

Batch (Option 4): Use "Batch" to count or measure specific amount of product in a container. Example: gallons in a barrel, peanuts in a jar, pills in a bottle, etc.
Batch Total: Use "Batch Total" to add the total number of batches of a specific product. Example: barrels in a tanker, jars in a box, boxes in a skid, skids in a truck, etc.

UPM FIG 4: Batch, Option 4



Frequency (Option 5): Use "Frequency" to totalize the number of pulses over a fixed measure of time. Example: 60 Hz = 60 cycles or pulses/second such as a household electrical line, 94.652 MHz might be the transmitting frequency of a radio broadcaster, etc. Note: "Frequency" is normally defined as events (pulses) per second (10/s, 1k/s/MHz). "Rate" is defined as events (pulses) per minute, hour, day for slow-occurring events versus a unit of time. See Rate (1/F), such as in oil rigs.

UPM FIG 5: Frequency, Option 5

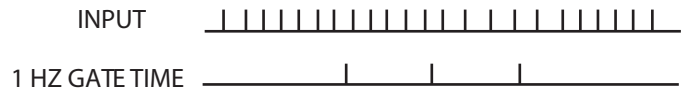

Build Your Own Part
 Number/User's Manual
 or Receive a Quote
 Online at:
[http://www.otekcorp.com/
 configurator/upm/](http://www.otekcorp.com/configurator/upm/)

SECTION B: COUNTERS (Continued)

5.1 De-bouncer/Filter: UPM's Debouncer (Filter) function is useful when the input signal is from relay contacts that "bounce" or are of an AC nature. Select a "debouncer" time base that covers the worst case condition of the bouncing signal. Relays typically have a bouncing time of 5–20mS, so a time base >25mS will be safe to use. However, if the switching (on-off) speed of the relay is <30mS, you should not use a time base greater than 25mS. The best time base would be approximately >15 and <20mS. This is also useful for AC power lines (>18mS for 60 Hz, >22mS for 50 Hz, or >3mS for 400 Hz power lines).

UPM FIG 5.1: De-Bounce, Option 5

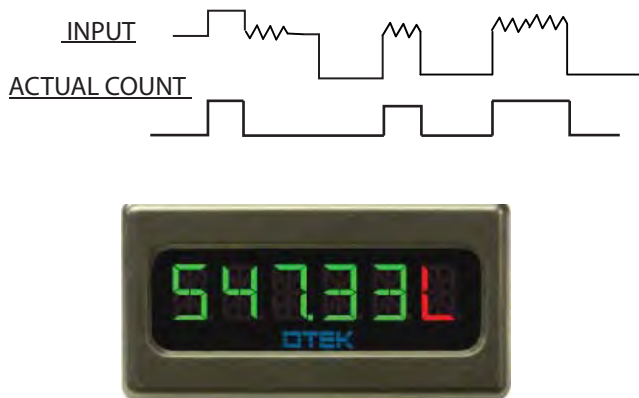

5.2 Burst: There are applications where it is desirable to measure the "burst" of a frequency input and ignore the base frequency. In this case, select a gate time > the minimum (maximum normal) burst frequency. Example: Normal: < 1 kHz, burst > 1.5 kHz < 20 kHz. Select a gate of 1.4 mS. The UPM will only display the burst's frequency of approximately 3.2 kHz. Want to count the number of bursts? Enable the counter function and the UPM will display the number of bursts since last reset.

UPM FIG 5.2: Burst, Option 5

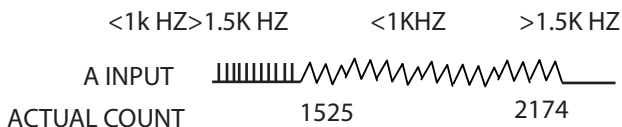

Period (Option 6): Use "Period" to measure/control the duration (width) of a signal transition from Logic 0 to Logic 1 (low -> high). Its measurement resolution is determined by the gate time selected (10 μS to 10 sec.). Again, you can use the math functions to meet your algorithm needs such as CHA + CHB, CHA - CHB, CHC x CHD, CHC/CHB/√, etc.

RADs (Option 7): Also known as units of radiation (radiation absorption dose) or "grey" units in SI. Radiation transmitters/sensors produce either analog output (4-20mA) or pulses. If pulses per "grey," you can accumulate (totalize) the number of pulses over a period of time. If analog, you can integrate logarithmically the total "dose." See integrator.

REMs (Option 8): A.K.A. Si (Sievert). Radiation detectors/transmitters produce either a pulse per unit of radiation (~0.01 Sievert) or analog signal (usually mV or 4-20mA). In either case, the UPM accepts both signals and if pulsed, it totalized the number of pulses received. If analog, it uses the integration function, along with the log or anti-log (contracting or expanding) for the reading and gives you the accurate rate (dose) of accumulated radiation in an area.

Custom (Option 9): Contact OTEK for your custom algorithm/application. Typical custom design that replaces F, F & F obsolete 20mA C.L. (teletype) input 1960's technology with the UPM-R.

(UPM-R)
1.5x5" Case



Up/Down Timer (Option A): Just like the Up/Down Counter (Option 1), but instead of using external pulses to count, the UPM uses its internal programmable time base to increment/subtract its count. Default is one (1) second, range is 1 μs to 10 seconds.

Time : There are three (3) times: **time interval** (Option B), **elapsed time** (Option C) and **range time** (Option D).

SECTION B: COUNTERS (Continued)

Elapsed time means time that has occurred from the starting point and range time means estimated time to end of task (if all conditions remain as they are). Elapsed time requires a time base selection, a "Start" pulse and an "End" pulse, both rising edge (positive Logic). Range time requires a time base selection (mS to seconds), a reference input signal (events/time base), and a "Total" goal or destination value.

Note: You can enable/disable the up/down function via serial command.

Example: Assume you want to know how long it will take to fill a tanker, whose capacity is 164,000 barrels, at a present rate of 3450 barrels/hr. However, if the rate varies to 2945 or 3649/hr, how long will it take in seconds, minutes, hours, or days? The **UPM** will automatically update its display and serial output as well as its analog output (for PID control) to inform you of the calculated end of process. All math functions are available for you to automatically select multipliers, dividers, or external variables as required. Also, you can use the V-F input option to convert analog inputs (4-20 mA, 1-5 V, etc.) to events for the range time algorithm. If you have a mileage "Range" indicator in your car, the **UPM's range** function works the same.

UP/DOWN TIMER

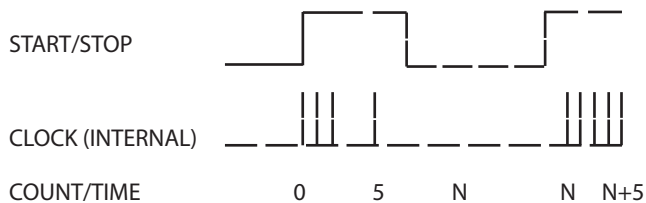

Time Interval (Option B, continued): This measures the time interval between two (2) inputs A and B and starts on the rising edge (↑) of Input A and stops on the rising edge (↑) of Input B. Alternatively, you can select the falling edge (↓) or start with Input B and select your time base (μS to seconds) and any actions to occur (relay, O.C.T, display change, math functions, average, etc.). If you use a "Gate Time" function, you can display/control the average of all the pulse widths that occurred during the gating time.

INTERVAL

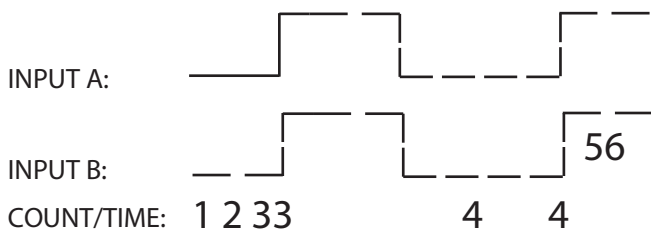

Elapsed Time (Option C): Depending on the model selected (number of characters/digits), you can display/control events in days, hours, minutes, seconds, mS, and μS (D:365, H:24, M:60, S:60, μS:000,000 for a 15 digit model(s) or 5 digits for the smallest package (-L). Use the relays, O.C.T. or analog output to control your process by setting limits/alarms (usually 00:00:00).

ELAPSED TIME

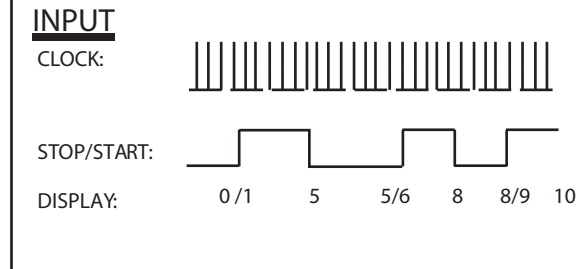

Range (Option D): This function is extremely useful in determining how long (range) the asset you have (fuel, beans, water, etc.,) will last you if you maintain the present usage at the present rate. It's no different than a retiree wishing that his money will outlast him, or wondering if you have enough gas to get to the next gas station or calculating whether the rods in a reactor will last until the next "load" arrives. All you need to do is enter the value of "In Stock," and the **UPM** will use prior (if programmed into the memory) information to determine the range. You can also enter the rate/unit (unit=time, events, etc.) and the **UPM** will calculate the range.

Contact sales@otekcorp.com with information on your transducer. You'll need to provide data such as:

- 1) Existing fuel intake
- 2) Fuel used (if not full)
- 3) Present consumption/time

The **UPM** will calculate the range based on actual use of fuel per unit of time or events.



Julian Clock {RTC} (Option E): Use "Julian Clock (RTC)" to indicate time, date, and year and control any loads via the four relays or analog output (4-20 mA) of any channel. Four and five digit models alternate the display as follows:

2014 (year) **12 (mo.) **27 (date) 10:15 or 20:15 (hrs and min) 45.07 (sec and mS)

or

2014 (year) *159 (day) **27 (date) 10:15 or 20:15 (hrs and min) 45.07 (sec and mS)

or month, date, year, time or time, date, month, year.

Place any callout in any order and use "*" to indicate dead space. Enable/disable any on-off (Relay/O.C.T.) at any specific time/date/year or analog output to any value.

Example 1: K1ON 2015**08 **15 07:15; K1OF 2015**09 **01 *9:30; Turns on Relay K1 on August 15th at 7:15 a.m.; turns Relay K1 off on September 1st at 9:30 a.m. in year 2015.

Example 2:

2015 (year)*AN1 *4.00 (mA) **10 (month) **19 (date) 23:59 (time)

2015 (year)*AN1 *8.50 (mA) **10 (month) **20 (date) 05:30 (time)

2015 (year) *AN112.00 (mA) **10 (month) **20 (date) 09:30 (time)

2015 (year) *AN116.00 (mA) **10 (month) **20 (date) 12:30 (time) 2015 (year)*AN1 20.00 (mA) **10 (month) **21 (date) 2400 (time)

Turns analog out to 4.0 mA on October 19th of 2015 at 23:59 (11:59 p.m.), holds it at 4 mA, then switches its outputs to 8.50 mA on the 20th of October at 5:30 a.m., then to 12.00 mA on October 20th at 9:30 a.m., then to 16.00 mA on the 20th of October at 12:30 p.m., then to 20.00 mA on October 21st of 2015 at 12 midnight (2400 hours).

Date/Time: You can make your own format to suit your country's needs. Just identify the label and sequence in moving message. You can control any and all four Relays and DAC per channel at will. Default format: U.S. standard: month – date – year – hour – minute – second. Note: Models with 12+ characters (-4) are best suited for calendar-controlled functions.

Rate (Option F): (also see "Frequency") Rate is used for slow occurring events such as strokes/minutes, GPM, LPM, barrels/day, etc. instead of fast occurring events which are measure in Hertz (usually seconds) such as radio frequencies or power lines.

F.1 Digital Mode Rate: Rate uses the 1/F formula to arrive at the rate per unit of time by counting the number of events that occur within the time base used. If you want to measure/control the process that produces approximately 1/second, use the 1 or 10 second time base. This will give you a reading of approximately 60 EPM (events/minute) or 3600/hr with fractions of an event (3600.3), if required. This is commonly used in oil rigs to measure the barrels/day produced without using a flow meter.

F.2 Analog Mode Rate: If your process produces an analog signal such as 4-20 mA, 1-5 mA, 1-5 V, 0-10V or other, you can use our option 1C, 2C, 3C or 4C (voltage to frequency) to convert/scale the analog to digital form and follow the example noted in Digit Mode Rate C.1. Rate is used to calculate/display the frequency of slow occurring events in a short period of time (seconds) without having to wait minutes, hours, or days to find their frequencies. All you need to do is select the time base (gate) in 0.1, 1, or 10 seconds and multiplier (60 [M], 3600 [H], 86900 [D]) to determine the unit of time.

Contact us at: sales@otekcorp.com.

Ratio (Option G): Ratio is the ratio of two (2) signals (A/B) to determine their positive (greater) or negative (smaller) frequency vs. each other. Normally, it is used to synchronize their zero crossings such as in power lines (synchrosopes), other matching frequency applications (radio broadcasts), or conveyor speed synchronization. Using the UPM analog output as proportionally controlled by the output of the "Ratio" function can automatically synchronize the objects similar to PID.

Phase Angle (Option H): (needs 2+ inputs) It measures the phase relationship between any two inputs and its value is displayed in degrees (0:00:00 to 360:00:00) formatted DDD:MM:SEC.000 (degrees, minutes, seconds, and milliseconds of rotation). Best with 6 digit models.

Draw (Option J): Use "Draw" to measure/control two variables that should maintain identical amounts, speed, velocity, etc. Draw = A/B – 1 is same as "Ratio," but 1 unit is subtracted from it to give you a zero display (differential) when their ratio is 1:1. Example: Two conveyors should be travelling at the same speed/tension/level and the UPM will display the differential between them.

V-F {Voltage to Frequency Converter} (Option K) : The UPM series offers an optional high accuracy and resolution V-F (also F-V) Converter capable of converting a 0-1 V signal (or 4-20mA and others on request) to 0-100 kHz giving you a 0.00001V (10µV) resolution (+/-0.000001% of full scale). When you use this option, converting pressure to flow and/or volume using the √ function becomes a very economical and accurate alternative to old techniques.



SECTION B: COUNTERS (Continued)

Integrations (Option L): Use "Integration" to integrate, accumulate or totalize events (pulses) over an open period of time (seconds, minutes, hours, days). Also see "Totalizer," "Event Counter," "REM Counter," "Logarithmic," "Anti-Log," and "Volume." Using our V-F (voltage to frequency counter) option, you can convert analog signals to frequency, such as pressure to flow and volume using our "Square Root" extractor function.

Examples: TBW

L.1 Square Root: This standard feature of the **UPM** allows you to convert the differential pressure from a pressure transmitter to instantaneous flow, and if you enable the integrator mode, to accumulate (per unit of time) the flow into volume.

SECTION C: REMOTE DISPLAYS

C) REMOTE DISPLAYS (Digits 8 & 9, option 58)

As a remote (serial input) display/controller, the **UPM** has no analog or digital inputs enabled or tested, but it can have On-Off Control (Digit 11) and/or Analog Outputs (Digit 12). This will allow you to control your process with your own commands/algorithm and simultaneously display an intelligent message to the operator (HMI/MMI). Imagine the possibilities!

SECTION D: CONTROLLERS

D) CONTROLLER:

It can function as a **controller:** It includes an isolated optional analog output (4-20mA) that is internally powered and capable of driving up to 1K Ohm loads. The SPDT relays (4/channel) are capable of driving up to one (1) Amp at 120VAC/30VDC resistive loads. 300V MOVs are included. The open collector transistors (O.C.T.) are isolated from the signal and power inputs and can drive up to 30mA@30VDC/VCE, such as S.S.R.

CUSTOMS

Class 1E (Nuclear Safety), Military (to specific MIL-Specs) and industrial grades are available. We have been supplying our armed forces, and the aerospace and nuclear industries for over 30 years.

SECTION E: OTHER USES

E. OTHER USES:

E.1 It can function as a **scientific meter:** It performs math functions (+, -, x, ÷, √), X-Y tables, polynomials, range, log-antilog with exponential (ideal for RAD/REM a.k.a. Gy/SV).

E.2 It can function as a **smart message center:** We use ultra-efficient 15 segment automatic tricolor (R/Y/G) LEDs for full alphanumeric display. Number of characters vary with model. Serial I/O includes isolated USB, RS485 or Ethernet.



E.3. It can function as a **data logger (paperless recorder):** Some models include an optional removable 32GB μSD memory card for data storage and it is configurable to meet your needs via simple commands. Standard factory configuration is when any limit is reached and include the units I.D. number, name, run time stamp, limit data and message.

E.4 **ABOUT ISOLATION:** All models in the OTEK **New Technology** series include 100% isolation (>500VDC) between **ALL** I/O, including serial I/O, power input, control outputs (relays and O.C.T.), analog outputs and signal (analog or digital) inputs. The **UPM-F** is "display only" and has no outputs.

CONCLUSION

CONCLUSION:

As you can see, the **UPM** is truly the **U**niversal **P**anel **M**eter you have been waiting for. All the listed functions (and more) are included and found in the User's Manual, making the **UPM** a versatile microcomputer with controlling capabilities superior to a **PLC** and inferior to it in cost and size. You can use it to perform most any task. If not, contact us to solve the problem together.

Use Note: Remember the **UPM's** recording capabilities with its exclusive 32 GB memory capacity. That can save you lots of headaches.



1, 2, 3 or 4 CHANNEL LOOP POWERED DISPLAY

UPM-5

**SEE NOTES
BELOW**

OTEKS TRC/OLC (3" x 6") Case

*Grades E, M & 9 might require an N.R.E. fee.

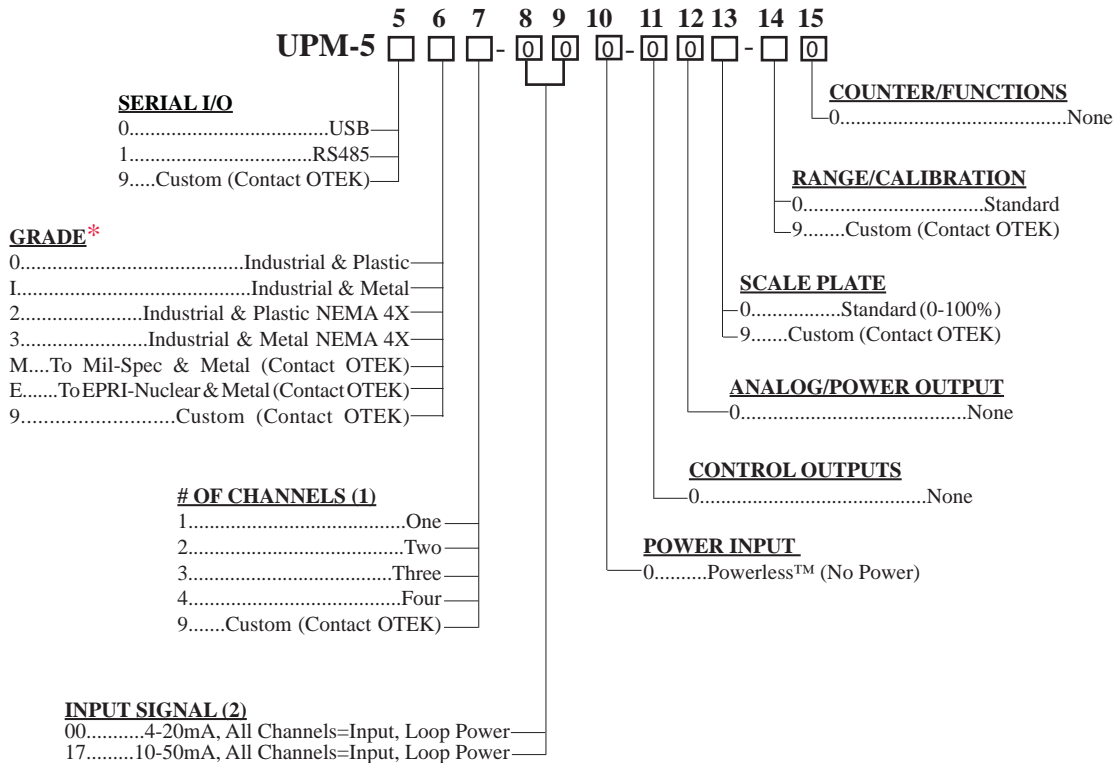

NOTES:

- # of input channels is governed by Digit 7.
- Option 00-18 only for loop/signal powered (Digit 10, option 0).



UPM-5 SIGNAL POWER VERSION ORDERING INFORMATION 10-12-17

**SEE NOTES
BELOW**

1, 2, 3 or 4 CHANNEL **SIGNAL** POWERED DISPLAY

UPM-5

OTEKS TRC/OLC (3" x 6") Case

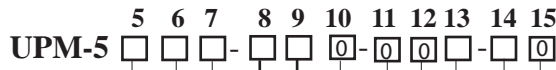

SERIAL I/O

- 0.....USB
- 1.....RS485
- 9.....Custom (Contact OTEK)

GRADE*

- 0.....Industrial & Plastic
- 1.....Industrial & Metal
- 2.....Industrial & Plastic NEMA 4X
- 3.....Industrial & Metal NEMA 4X
- M....To Mil-Spec & Metal (Contact OTEK)
- E.....To EPRI-Nuclear & Metal (Contact OTEK)
- 9.....Custom (Contact OTEK)

COUNTER/FUNCTIONS

- 0.....None

RANGE/CALIBRATION

- 0.....Standard
- 9.....Custom (Contact OTEK)

SCALE PLATE

- 0.....Standard (0-100%)
- 9.....Custom (Contact OTEK)

ANALOG/POWER OUTPUT

- 0.....None

CONTROL OUTPUTS

- 0.....None

POWER INPUT

- 0.....Powerless™ (No Power)

OF CHANNELS (1)

- 1.....One
- 2.....Two
- 3.....Three
- 4.....Four
- 9.....Custom (Contact OTEK)

*Grades E, M & 9 might require an N.R.E. fee.

INPUT SIGNALS (2)

- 01.....Volts A.C., All Channels, Signal Power
- 02.....5 Amps A.C., All Channels, Signal Power
- 03.....Watts A.C., All Channels, Signal Power
- 04.....Hertz A.C.V., All Channels, Signal Power
- 05.....Mixed 2 Channel.....Ch. 1: VAC; Ch. 2: AAC, Signal Power
- 06.....Mixed 2 Channel.....Ch. 1: VAC; Ch. 2: WAC, Signal Power
- 07.....Mixed 2 Channel.....Ch. 1: VAC; Ch. 2: Hz, Signal Power
- 08.....Mixed 2 Channel.....Ch. 1: AAC; Ch. 2: WAC, Signal Power
- 09.....Custom (Contact OTEK)
- 10.....Mixed 3 Channel.....Ch. 1: V; Ch. 2: A; Ch. 3: W, Signal Power
- 11.....Mixed 3 Channel.....Ch. 1: V; Ch. 2: A; Ch. 3: Hz, Signal Power
- 12.....Mixed 3 Channel.....Ch. 1: V; Ch. 2: W; Ch. 3: Hz, Signal Power
- 13.....Mixed 3 Channel.....Ch. 1: A; Ch. 2: W; Ch. 3: Hz, Signal Power
- 14.....Mixed 4 Channel.....Ch. 1: V; Ch. 2: A; Ch. 3: W; Ch. 4: Hz, Signal Power
- 16.....7-130 Volts D.C., All Channels, Signal Power
- 18.....10-500mADC, All Channels=Input, Signal Power

NOTES:

1. # of input channels is governed by Digit 7.
2. Option 00-18 only for loop/signal powered (Digit 10, option 0).



**SEE NOTES
BELOW**

1, 2, 3 OR 4 CHANNEL **EXTERNAL** POWERED CONTROLLER

UPM-5

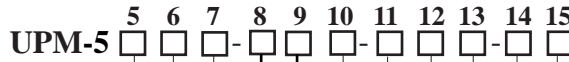

SERIAL I/O

- 0.....USB
- 1.....RS485
- 2.....Ethernet
- 3.....USB & μSD Memory (Pending)
- 4.....RS485 & μSD Memory (Pending)
- 9.....Custom (Contact OTEK)

GRADE*

- 0.....Industrial & Plastic
- 1.....Industrial & Metal
- 2.....Industrial & Plastic NEMA 4X
- 3.....Industrial & Metal NEMA 4X
- M.....To Mil-Spec & Metal (Contact OTEK)
- E.....To EPRI-Nuclear & Metal (Contact OTEK)
- 9.....Custom (Contact OTEK)

OF CHANNELS (1)

- 1.....One
- 2.....Two
- 3.....Three
- 4.....Four
- 9.....Custom (Contact OTEK)

INPUT SIGNAL (2-6)

See Page 18 and enter option number for Digits 8 & 9.

POWER INPUT

- 1.....Non-Isolated USB
- 2.....Isolated 5VDC
- 3.....Isolated 7-32VDC
- 4.....Isolated 90-265VAC
- 9.....Custom (Contact OTEK)

COUNTER/FUNCTIONS

- 0.....None (Use Digits 8 & 9)
- 1.....Up/Down Counter
- 2.....Totalizer
- 3.....Quadrature
- 4.....Batch
- 5.....Frequency
- 6.....Period
- 7.....RADS
- 8.....REM
- 9.....Custom
- A.....Up/Down Timer
- B.....Time Interval
- C.....Elapsed Time
- D.....Range
- E.....Julian Clock
- F.....Rate
- G.....Ratio
- H.....Phase Angle
- J.....Draw
- K.....V-F (Voltage to Frequency)
- L.....Integration

NOTE: If you select option 0 on Digit 15, you cannot have 1-4 A, B or C as your input signal on Digits 8 & 9.

RANGE/CALIBRATION

- 0.....Standard
- 9.....Custom (Contact OTEK)

SCALE PLATE

- 0.....Standard (0-100%)
- 9.....Custom (Contact OTEK)

ANALOG/POWER OUTPUT

- 0.....None
- 1....CH. 1.....4-20mA Out
- 2....CH. 1.....30V Out
- 3....CH. 1 & 2.....4-20mA Out
- 4....CH. 1 & 2.....30V Out
- 5....CH. 1, 2 & 3.....4-20mA Out
- 6....CH. 1, 2 & 3.....30V Out
- 7....CH. 1, 2, 3 & 4.....4-20mA Out
- 8....CH. 1, 2, 3 & 4.....30V Out
- 9.....Custom (Contact OTEK)

CONTROL OUTPUTS

- 0.....None
- 1....CH. 1.....O.C.T. (4)
- 2....CH. 1.....Relays (4)
- 3....CH. 1 & 2.....O.C.T. (8)
- 4....CH. 1 & 2.....Relays (8)
- 5....CH. 1, 2 & 3.....O.C.T. (12)
- 6....CH. 1, 2 & 3.....Relays (12)
- 7....CH. 1, 2, 3 & 4.....O.C.T. (16)
- 8....CH. 1, 2, 3 & 4.....Relays (16)
- 9.....Custom (Contact OTEK)

*Grades E, M & 9 might require an N.R.E. fee.

NOTES:

1. # of input channels is governed by Digit 7.
2. Option 00-18 only for loop/signal powered (Digit 10, option 0).
3. Options 20 thru 58 available for all models; options 60 thru 2C only for models with 2+ channels (digit 7, options 2-4); Options 70-3C only for models with 3+ channels (digit 7, options 3 or 4); options 80-4C only for digit 7, option 4.
4. Options 20 through 4C only for externally powered models (Digit 10, options 1-9).
5. Option 1A accepts 5V TTI/CMOS inputs or dry contacts (10KΩ pull ups). Option 1B accepts dry contacts to 150V DC/AC pulses. See "Debouncer/Filter" definitions. Option 1C accepts 0-1V DC & 4-20mA. See "V-F" definition. Conditions: If digit 15="0," then digits 8 & 9 must be options 00-89 and vice-versa. If digit 15="1" thru "L" then digits 8 & 9 must be 1A-4C and digit 10 (power) must be option 1-9. Option H (Phase angle) requires 2 inputs.
6. In multi-channel models, all channels have the same input function. For mixed inputs, use options 69, 79 or 89 and specify. Consult OTEK for avail



MODEL UPM-5 DIGITS 8 & 9 INPUT SIGNAL ORDERING INFORMATION 10-12-17

AVAILABLE ON EXTERNAL POWER MODELS ONLY

INPUT SIGNAL

UPM-5

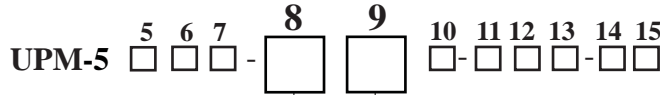

INPUT SIGNAL (2-6)

- 20.....4–20mA (All Channels Same Input)
- 21.....100mV DC F.S.
- 22.....1VDC F.S.
- 23.....10VDC F.S.
- 24.....100VDC F.S.
- 25.....10mADC F.S.
- 26.....100mADC F.S.
- 27.....Watts DC (1Vx1A) F.S.
- 28.....Watts DC (1Vx1V) F.S.
- 29.....Custom (Contact OTEK)
- 30.....0.1V RMS F.S.
- 31.....1V RMS F.S.
- 32.....10V RMS F.S.
- 33.....150V RMS F.S.
- 34.....250 V RMS F.S.
- 35.....0.1A RMS F.S.
- 36.....1A RMS F.S.
- 37.....5A RMS F.S.
- 38.....W RMS (1Vx1VAC) F.S.
- 40.....W RMS (120Vx5A AC) F.S.
- 41.....Hertz (10KHz/5V Logic) F.S.
- 42.....Hertz (120VAC/40-100 Hz) F.S.
- 43.....Hertz (240VAC/30-100 Hz) F.S.
- 44.....Hertz (120VAC/500 Hz) F.S.
- 45.....Strain-Gage ($\geq 300 < 4K$ Ohm)
- 47.....RTD (PT100)
- 48.....RTD (PT1000)
- 50.....TC (Type J)
- 51.....TC (Type K)
- 52.....TC (Type T)
- 53.....pH (0-14.00)
- 54.....ORP (0-2000mVDC)
- 55.....% RH (Specify Sensor)
- 56.....Resistance (0-10K Ω)
- 57.....10-50mA F.S.
- 58.....None (Serial Input Remote Meter)
- 1A.....Any Digit 15 TTL Input Level
- 1B.....Any Digit 15 H.V. Input Level
- 1C.....Any Digit 15 V-F (Option K) Input Level

MIXED INPUT SIGNALS (2 CHANNELS)

- 60.....Ch.1: 1V; Ch.2: 1A (.2 Ω) DC
- 61.....Ch.1: 10V; Ch.2: 1A (.2 Ω) DC
- 62.....Ch.1: 100V; Ch.2: 1A (.2 Ω) DC
- 63.....Ch.1: 100V; Ch.2: 5A (.04 Ω) DC
- 64.....Ch.1: 150V; Ch.2: 5A (.04 Ω) RMS
- 65.....Ch.1: 250V; Ch.2: 5A (.04 Ω) RMS
- 66.....Ch.1: 150V; Ch.2: 100Hz (120 V Line) RMS
- 67.....Ch.1: 250V; Ch.2: 100 Hz (240V Line) RMS
- 68.....None, Serial Input Only
- 69.....Custom (Contact OTEK)
- 2A.....Any Digit 15 TTL Input Level
- 2B.....Any Digit 15 H.V. Input Level
- 2C.....Any Digit 15 V-F (Option K) Input Level

MIXED INPUT SIGNALS (3 CHANNELS)

- 70.....Ch.1: 1V; Ch.2: 1A (.2 Ω); Ch.3: W DC
- 71.....Ch.1: 10V; Ch.2: 1A (.2 Ω); Ch.3: W DC
- 72.....Ch.1: 100V; Ch.2: 1A (.2 Ω); Ch.3: W DC
- 73.....Ch.1: 100V; Ch.2: 5A (.04 Ω); Ch.3: W DC
- 74.....Ch.1: 150V; Ch.2: 5A (.04 Ω); Ch.3: W RMS
- 75.....Ch.1: 250V; Ch.2: 5A (.04 Ω); Ch.3: W RMS
- 76.....Ch.1: 150V; Ch. 2: 5A (.04 Ω); Ch.3: 100Hz RMS
- 77.....Ch.1: 250V; Ch. 2: 5A (.04 Ω); Ch.3: 100 Hz RMS
- 78.....None, Serial Input Only
- 79.....Custom (Contact OTEK)
- 3A.....Any Digit 15 TTL Input Level
- 3B.....Any Digit 15 H.V. Input Level
- 3C.....Any Digit 15 V-F (Option K) Input Level

MIXED INPUT SIGNALS (4 CHANNELS)

- 80.....Ch.1: 150V; Ch.2: 5A (.04 Ω); Ch.3: W; Ch.4: 100Hz RMS
- 81.....Ch.1: 250V; Ch. 2: 5A (.04 Ω); Ch.3: W; Ch.4: 100 Hz RMS
- 82.....Ch.1: 120V; Ch. 2: 5A (.04 Ω); Ch.3: W; Ch.4: 500 Hz RMS
- 83.....Ch.1: 250V; Ch. 2: 5A (.04 Ω); Ch.3: W; Ch.4: 500 Hz RMS
- 88.....None, Serial Input Only
- 89.....Custom (Contact OTEK)
- 4A.....Any Digit 15 TTL Input Level
- 4B.....Any Digit 15 H.V. Input Level
- 4C.....Any Digit 15 V-F (Option K) Input Level

NOTES:

1. # of input channels is governed by Digit 7.
2. Option 00-18 only for loop/signal powered (Digit 10, option 0).
3. Options 20 thru 58 available for all models; options 60 thru 2C only for models with 2+ channels (digit 7, options 2-4); Options 70-3C only for models with 3+ channels (digit 7, options 3 or 4); options 80-4C only for digit 7, option 4.
4. Options 20 through 4C only for externally powered models (Digit 10, options 1-9).
5. Option 1A accepts 5V TTI/CMOS inputs or dry contacts (10K Ω pull ups). Option 1B accepts dry contacts to 150V DC/AC pulses. See "Debouncer/Filter" definitions. Option 1C accepts 0-1V DC & 4-20mA. See "V-F" definition. Conditions: If digit 15="0" then digits 8 & 9 must be options 00-89 and vice-versa. If digit 15="1" thru "L" then digits 8 & 9 must be 1A-4C and digit 10 (power) must be option 1-9. Option H (Phase angle) requires 2 inputs.
6. In multi-channel models, all channels have the same input function. For mixed inputs, use options 69, 79 or 89 and specify. Consult OTEK for avail

UPM-5 MECHANICALS AND TYPICAL CONNECTIONS

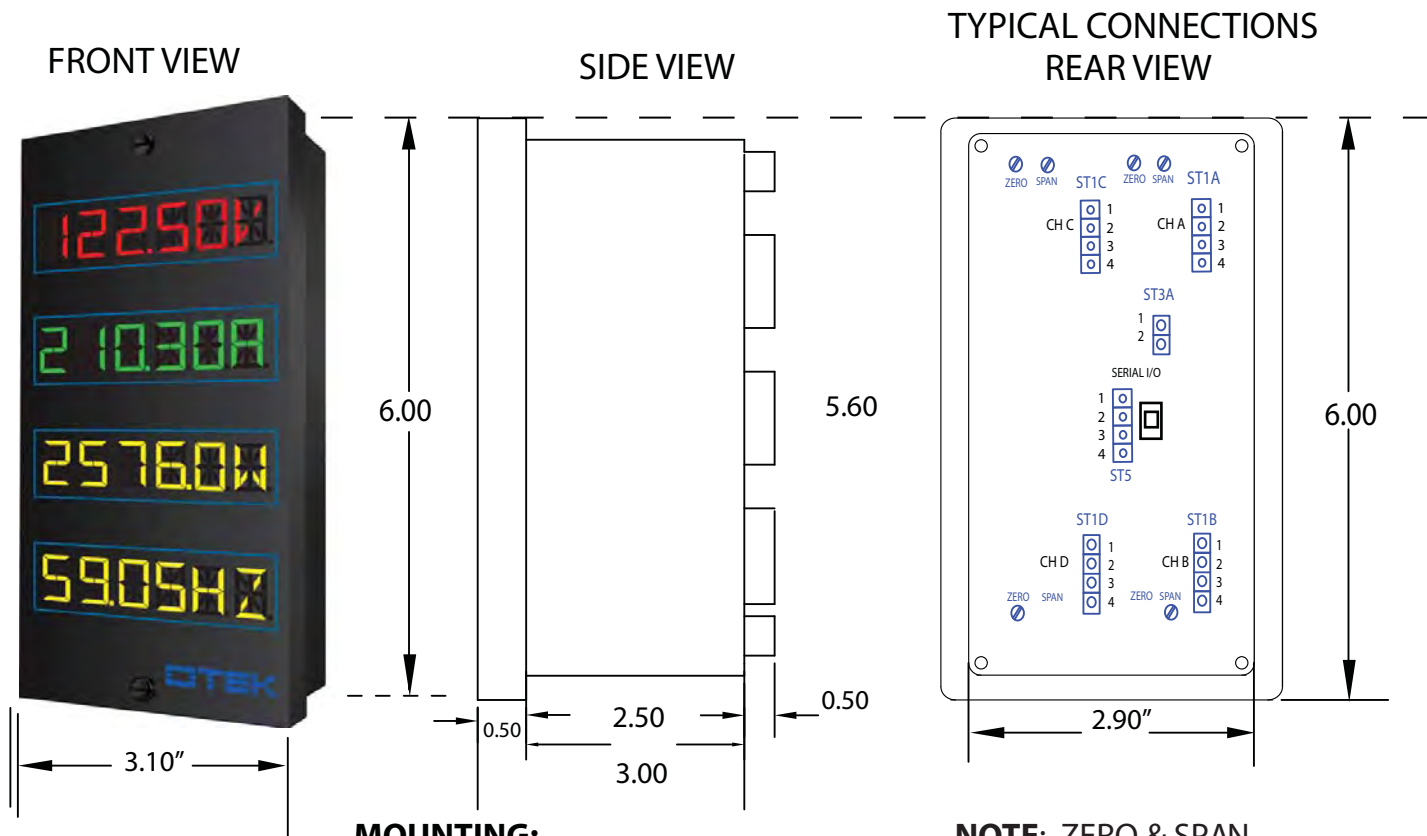

MOUNTING:

1. REMOVE FILTER
2. TWIST MOUNTING TABS (2) CLOCKWISE
3. REPLACE FILTER

NOTE: ZERO & SPAN POTS. ON REQUEST ONLY.

PANEL CUT-OUT: 3.05x5.6"

NOTE: 1" DEPTH IS FOR METAL (OPTIONS I, M or E) ONLY.

SEE CUSTOMIZED USER'S MANUAL FOR SPECIFIC CONNECTIONS at:

<http://www.otekcorp.com/configurator/upm/>

NEW! Part Number Configurator!

1. Compare models in our new UPM Series
 2. Build a part number within seconds
 3. Get instant pricing
 4. Get a custom user's manual
- Another OTEK innovation!

www.otekcorp.com/configurator/nts/

DOWNLOADS:

For manuals, user-software or drivers:

www.otekcorp.com

