

NEW

**LOOP POWERED LCD BARGRAPH FOR
MIL-SPEC - NUCLEAR & HI-REL. INDUSTRIAL
>20 INPUT SIGNAL CONDITIONERS**

**MODEL
LBD**

FEATURES:

- Powered or Powerless™
- RS232, 485, USB, I/O
- 101 Bars, & 4 1/2 Digit LCD Display
- Bi-Polar With Center Zero
- Optional Automatic Tricolor Backlight
- Fits Industry's Standard 5.7 X 1.77" Cutout
- **NEMA 3**, Front Panel, 2.5" Deep
- No Input Reflected Noise
- Remote Display With Serial Input
- Optional Relay or O.C.T. Outputs (4)
- Four Alarm Annunciators
- Stand Alone Or DCS/SCADA Use
- Replaces GE/Yokogawa 180; Prime, Signal, Int'l. Inst., Bowmar #1151, Westinghouse/Weschler VX251, Dixon/Ametek BB101, A &M/Weston, Triplet, Takemoto, NES and Other 6" Type, but has a Lifetime Warranty!
- See **EBD** For LED Version



SPECIFICATIONS @ 25°C

Loop Powered Models:

- Burden: 5.5V Max. (7V for "S" Version)
- Maximum Input Current: 36mA
- Minimum Input Current: 3.6mA
- Accuracy & Linearity: $\pm 0.1\%$ of F.S.
- Span Adj.: ± 3000 Counts of F.S.
- Zero Adj.: ± 3000 Counts of Zero
- Standard Cal.: 4-20 = 0-10000/100%
- Serial I/O: RS232E

OTHER SPECIFICATIONS

- Viewing Angle: 6 O'Clock $\pm 45^\circ$
- Bars: 101 Each 1" Wide
- Digits (5) & Annunciators (4): 0.4" High
- Input Type: Differential & Single Ended.
- RS232E: Parasitic 300-9600KB

EXTERNALLY POWERED MODELS

- Loop Burden: 1V @ 20mA, VinZ: 10MOhms
- Relays: 4 Ea. 1 Amp SPDT (200mA @ 5VDC) or O.C.T. 30V/100mA
- Backlight: Automatic/Manual Tricolor Red, Green, Orange (20mA @ 5VDC)
- Power For Transmitter: 30VDC @ 30mA (200mA) or
- Isolated Retransmission: 4-20mA, 500 Ohm Max. (200mA)
- Fully Loaded 750mA @ 5VDC

ENVIRONMENTAL:

- *Op/Storage Temp.: -10 + 70°C/-20 + 80°C
- *Humidity: 5-95RH Non-Condensing
- *MTBF: >100,000 Hours

DESCRIPTION

The Innovator & Leader on Automatic Tricolor Bargraphs, now offers you the latest technology for replacement and new applications. The New **LBD** Series uses a highly integrated DSP and nanowatt microcontroller along with a proven software package approved and used by the Military & Nuclear Industries.

SIGNAL CONDITIONERS: 20+ signal conditioners are available (more soon). See ordering information and description section.

The **LBD** is available in 2 basic versions:

1. **Loop Powered:** Uses **NANOWATT** Technology for display, RS232E I/O and Automatic Tricolor Backlight.

2. **Externally Powered:**

ANALOG INPUTS: Industry's standard 4-20mA, mA and VDC are included. Custom signal conditioners for %RH, pH, TC, RTD, RMS, S-G and more are available on request.

MATH FUNCTIONS: RTD, TC & X-Y linearization plus Tare, Offset, Scale, Peak and more are programmable via simple commands.

CONTROL OUTPUTS: 4 each relays or 4 open collector transistors for High, High-High, Low and Low-Low Control.

ANALOG OUTPUT: Optional isolated 0-1mA, 4-20mA, 0-20mA or 0-5VDC with 16 Bit resolution. (Needs Serial I/O)

SERIAL I/O: Standard is RS232 with optional RS485 or **USB**.

POWER INPUT: Standard is 5VDC with optional isolated 7-32VDC, 90-265VAC.

POWER OUTPUT FOR 4-20mA TRANSMITTER:

Only available with **External Power** either non-isolated 28VDC @ 20mA or isolated 30V @ 20mA. See Control Outputs and Note 7.

520-748-7900

FAX: 520-790-2808
E-MAIL: sales@otekcorp.com
http://www.otekcorp.com

OTTEK™
CORP.
SINCE 1974

4016 E. TENNESSEE ST.
TUCSON, AZ. 85714 U.S.A.

MADE
IN
USA



LBD Series continued

HOW IT WORKS:

Current Loop Powered: We use a Zener to clamp the voltage to 5V max. and monitor the Loop's current (we invented it in 1974). (Digit 2, Option 0).

VDC Signal Powered: We monitor the voltage with high impedance and clamp it to a safe level to power the **LBD**. (Digit 2, Option 2).

AC Signal Powered: For VAC & Hz we use a capacitor limiting rectifier to power the **LBD** and monitor the VAC with an RMS-DC converter. For Hz we use an F-V for accurate conversion. For A.A.C. we invented (Pat. #: 4,908,569) a C-V converter to extract the current from your C.T. for power and monitor the signal with RMS-DC. (Digit 2, Options Q-T).

Externally Powered: Non-Isolated 5VDC or isolated 5-32VDC or 90-265VAC 50/60Hz is optional (Digit 3, Options 1-8). Max Power: 150mW. Plus Options.

DISPLAY (Digit 4): Standard is 0-FS signal=0-100% & 0-10,000 counts. Or use Option #9 and specify.

Serial I/O: The **CPU** controls the Baud Rate (1200-19200 Baud, default 9600), the relays, analog output, math functions, linearization polynomial (9th) & X-Y tables.

Control & Power Out (Digit 6): You can order 4-20mA as standard, or 0-5V, 0-20mA out or you can order the isolated 30VDC (3mA, Options 4, 7, 8).

Relays/O.C.T. (Only for Powered Models): Either four (4) relays (SPDT) rated contacts for 1A@120VAC resistive with ~500ms response, with built in varistors or 4 open collector transistors rated at 30 VDC/30mADC common emitter, with < 500ms response.

THE SIGNAL CONDITIONERS: (2nd Digit)

Option 0: 4-20mA Loop Powered: First introduced in 1975, the current flows through a Zener and "Shunt" resistor. The Zener clamps the voltage to about 5.0 Volts and the voltage across the Shunt is measured and displayed. If the "burden" (3.5 - 5.5V) is too high for your application, use the externally powered version. **Accuracy:** ±0.05% of F.S.

CONNECTIONS:

FIG. LBD-0

LOOP POWERED

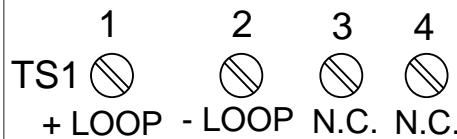

Option 1: 4-30VDC Signal Powered:

Another **OTEK** innovation. The voltage signal powers an **LDO** to protect the **LBD** and a divider network is used to measure and display the signal. If the input resistance of this Option is too low (~ 500 Ohms), use powered models. Power Input must be Option 0 (Powerless).

Accuracy: ±0.1% of F.S.

CONNECTIONS:

FIG. LBD-1, 4-30V IN

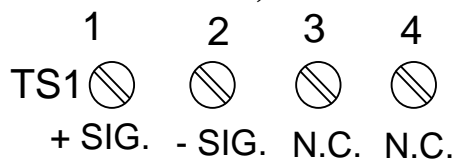

Option 2: 4-20mA Externally Powered: It only drops 1.0V @ 20mA (50 Ohms) but the "**LBD**" needs 5VDC @ 30mA to operate (including the backlight). Power Input must be Options 1-8.

Accuracy: ±0.05% of F.S.

CONNECTIONS:

FIG. LBD-2 (2-B, G, H, L-N)

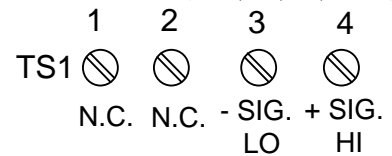

Options 3-6: VDC & mADC Externally Powered:

Input impedance is 1 Mega Ohm on all VDC ranges and 100 Ohm on 2mA and 1 Ohm on 200 mADC ranges.

Accuracy: ±0.05% of F.S.

CONNECTIONS:

FIG. LBD-2 (2-B, G, H, L-N)

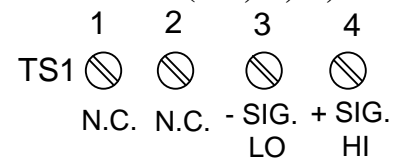

Options 7, 8 & A:

V & mA RMS: Here we use a **True RMS-DC** Converter for accurate (± 0.05%) measurement of sine waves up to 10KHz (± 0.1% for 10-20KHz) and SCRs fired to ± 1%. Input impedances vs. range are the same as for VDC & mADC ranges.

Warning: No Isolation!

Accuracy: ±0.05% of F.S.

CONNECTIONS:

FIG. LBD-2 (2-B, G, H, L-N)

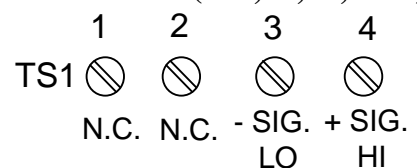

LBD Series continued

Option 9: Custom: Use this option to describe any custom input, scale or modification to the **LBD** and contact us for feasibility and cost.

Option B: 5Amps AC:

Specifically for current transformers (**C.T.**) this option requires an externally mounted (supplied) 0.05 Ohm, 0.1% 5 Watt resistor. You can mount the "Shunt" at your **C.T.** or next to the **LBD** but make sure the connections are "Perfect" to electrical codes. The C.T. might have "**Lethal**" **High Voltage** without a "Shunt" (Open) and the **LBD** will "Smoke".

See OTEK's New **ACS & CTT** models for **C.T.** powered instruments (Pat. # 7,626,378) or use option "R."

Warning: No Isolation!

Accuracy: ±0.05% of F.S.

CONNECTIONS:

FIG. LBD-2 (2-B, G, H, L-N)

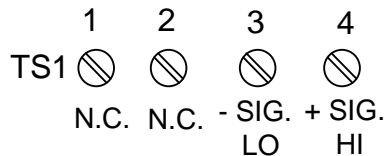

Option C: Strain-Gage (<1000 Ohm Type): Here we use a high accuracy and stability constant current (~1mA) source, and a differential amplifier to convert the 2 or 3mV/V (typical) sensitivity of your "Loadcell". **Specify** your Strain-Gage sensitivity and full scale and the **LBD's** display at Zero and Full Scale Please!

Accuracy: ±0.05% of F.S.

CONNECTIONS:

FIG. LBD-C/D (S-G)

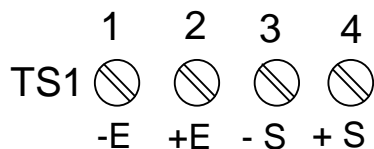

Option D: Strain-Gage (≥1K < 5K Ohm): These are typically "Monolithic" **S-G** that require constant voltage (preferably) excitation. We use 4.096V for high stability and accuracy. **Specify** your S-G impedance and sensitivity and the **LBD's** display at Zero and Full Scale.

Accuracy: ±0.1% of F.S.

Note on S-G: Some S-G offer +/- 1VDC or 4-20mA condition output. Use Option 9 and specify.

CONNECTIONS:

FIG. LBD-C/D (S-G)

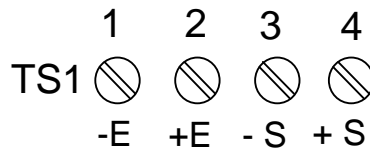

Option E: RTD (PT100): We

excite your 2, 3 or 4 wire RTD with 200µA to avoid the "self heating" effect. The range of the **LBD** is the same as your **RTD** typically -200°C to +800°C (-328 + 1562°F). You can place the decimal point at will (typically -200.0 to 800.0 (-328.0 to 1562.0)). The **PT100** has a temperature coefficient of 0.00385 Ohms/Ohm/°C. To change from °C to °F or PT100 to ANSI 392, use simple commands via serial port.

Accuracy: ±0.5% of F.S. plus sensor's error.

Note: For 2 wire, jump - S to -E and +S to +E. For 3 wire only jump -S to -E.

CONNECTIONS:

FIG. LBD-E/F (RTD)

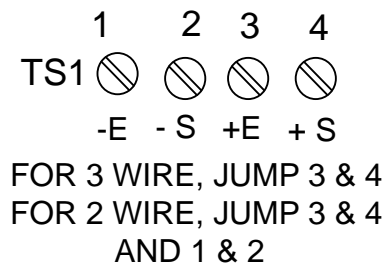

Option F: RTD (PT1000): Same as PT100 except it is 1000 Ohms at 0°C instead of 100 Ohms @ 0°C. The same technique is used. For copper **RTD** (10 Ohm), contact **OTEK**. Same connection as Option E apply.

Accuracy: ±0.5% of F.S. plus sensor's error.

Note: For long distances use a 4-20mA transmitter such as our 900 or LPT series.

CONNECTIONS:

FIG. LBD-E/F (RTD)

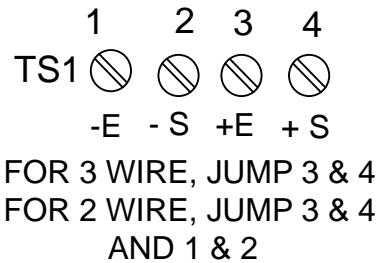

Options G&H: Frequency Input:

We use an **F-V** to accept frequencies from 40 - 20KHz and amplitudes from 1-400V peak, dry contact or open collector transistor (O.C.T.). For 50 or 60Hz power line frequency measurement. Use Option "H" or "S."

Accuracy: ±0.05% of F.S.

CONNECTIONS:

FIG. LBD-2 (2-B, G, H, L-N)

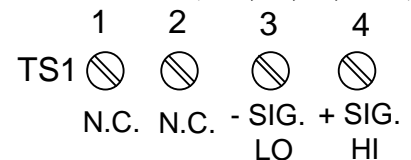

LBD Series continued

Option J: Thermocouple (Type J): This TC has a range of -210 to + 1200°C (-346 to + 2192°F). Its color is white (+) and Red (-), cold junction (CJ) is at terminals 1 and 2. Make sure the connections from the LBD and your TC are as close to the LBD's entrance as possible to avoid errors. If you short out the LBD's +TC & -TC together, the LBD will read the ambient temperature due to its built-in C.J.C. (Cold Junction Compensation).

NOTE: You can change from °C to °F and TC type via simple commands on serial port.

Accuracy: ± 2° F/C of signal input.

CONNECTIONS:

FIG. LBD-J/K (TC)

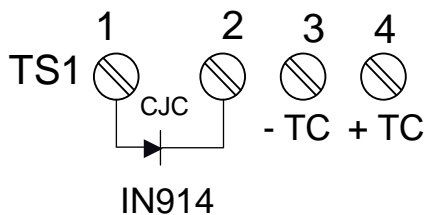

Option K: TC (Type K): This is amber (+) and red (-) and has a range of -200 to + 1372°C (-328 + 2502°F). The same notes as Option J.
Accuracy: ± 2° F/C of signal input

For Other TC use #9 and Specify.

CONNECTIONS:

FIG. LBD-J/K (TC)

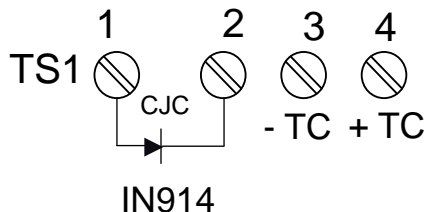

Option L: %RH: This conditioner is designed to interface to a typical (capacitance type) 2-3pF/% of RH made by several manufacturers. Use Option 9 and contact OTEK to specify your sensor's specifications.

Accuracy: ± 2% RH of signal input.

CONNECTIONS:

FIG. LBD-2 (2-B, G, H, L-N)

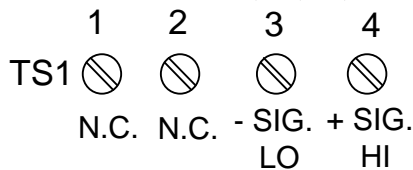

Option M: pH (Acidity): We use a FET input (10¹⁵) amplifier and calibrate the LBD for 0-14.00 pH using the Industry's standard ± 413 mV = ± 7pH coefficient.

Note: Not temperature compensated. Standard display is 0-100% and 0-10,000 counts or use Digit 9, Option 9 and specify.

Accuracy: ±0.05% of F.S.

CONNECTIONS:

FIG. LBD-2 (2-B, G, H, L-N)

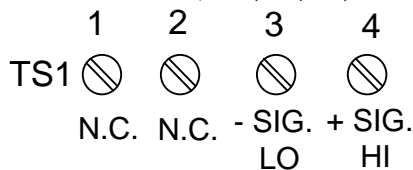

Option N: ORP (Oxygen Reduction Potential): Our FET amplifier (10⁹) accepts the industry standard 2000mV F.S. of the probe and the LBD displays it in % (0-100.00%).

Accuracy: ±0.05% of F.S.

CONNECTIONS:

FIG. LBD-2 (2-B, G, H, L-N)

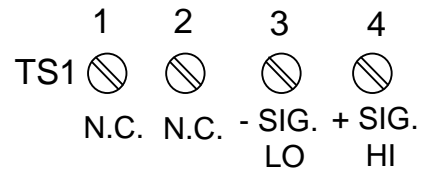

Option P: Hi Speed Peak & Hold (P&H): Now you can capture fast transients greater than 5 microseconds (even faster soon) with resolution greater than 0.1% of F.S. and retention of greater than 10 years (Due to OTEK's new and patent-pending P&H Option).

Input: 2VDC/mADC F.S. (Specify Range). Contact OTEK for V/mA RMS or Loop Powered.

Accuracy: +/- 0.1% of F.S. +/- 1 Digit

Linearity & Resolution: +/- 0.1% of F.S.

Response time: >200KHz (<5us)

Retention: >10 years (with power on)

CONNECTIONS:

FIG. LBD-P (P & H)

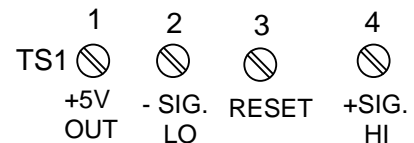

RUN: JUMP 3 & 2
RESET: PULSE 2 & 3
PIN 3 HAS 10K PULL UP TO +5V

LBD SERIES continued

Note: Options Q-T only available with Powerless™ Signal power input (Option 0, Digit 3).
(PAT. #: 4,908,569)

Option Q: VAC Signal Powered: Warning! No Isolation! This option uses the AC Voltage Signal to power the **LBD**. Since the **LBD** uses about 30mA @ 5VDC, we use a coupling capacitor AC-DC converter to generate 5VDC and not to "Load" the signal with a transformer. Consequently, your signal source should be capable of producing about 150mW without overloading it, otherwise use Options 7 or 8 (externally powered). Range: 50-150VAC; Method: RMS Calibrated; Accuracy & Linearity: ±0.5% of F.S. Best and safest when driven by a P.T. (Potential Transformer). **Always turn power off before connecting!**

**CONNECTIONS:
FIG. LBD Q-T**

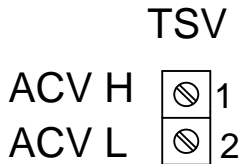

Option R: AAC Signal Powered:

Warning! No Isolation! (Pat. #: 7,626,378)
OTEK's Patented technique permits the extraction of power from a regular **C.T.** (Current Transformer) to power the **LBD** without distorting the signal. Since this option is designed to be powered from a C.T., it should not be connected directly to the mains without limiting the current and proper electrical grounding. **Lethal Voltage** might be present at the C.T. secondary (output) if the secondary is open.

Always turn power off before connecting! Range (at C.T. output): 0.1-5AAC; Overload: 50%/30 seconds; Peak: 100%/1 second; Conversion: True RMS; Accuracy & Linearity: ±0.05% of F.S.; Burden on C.T.: <150mW. Hz: 45-65.

**CONNECTIONS:
FIG. LBD-R**

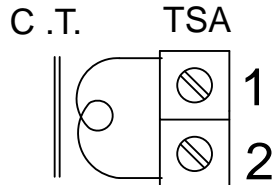

Option S: Hertz (Frequency) Signal Powered: Warning! No Isolation!

This option uses the same power technique as Option Q above and the same precautions and warnings apply. Here we use a "Zero Crossing" detector and a F-V converter to give you the **A.C.** line frequency display with 0.1 Hz resolution. Range: VAC: 50-440VAC/ Frequency: 30-100Hz; Accuracy & Linearity: ±0.05% of F.S. For 400 Hz line use #9 & specify range.

**CONNECTIONS:
FIG. LBD Q-T**

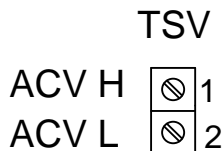

Option T: Signal Powered AC Watts: Warning! No Isolation!

Here we combine the powerless VAC & AAC options to arrive at real power calculations through our **CPU** and **DAC**. The same warnings and precautions of Options Q & R apply. Range: VAC: 50-150; AAC: 0.1 - 5A; Frequency: 40-450Hz; Accuracy & Linearity: ±0.1% of F.S.; Conversion: True RMS. Hz: 45-65.

Contact **OTEK** for other functions.

**CONNECTIONS:
FIG. LBD-T**

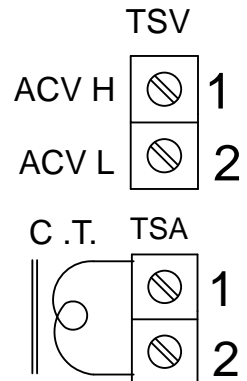

Power/Input (Digit 3):

Option 0: Powerless™: The **LBD** is powered from the signal that it measures. **ONLY** available for options 0, 2, and Q through T of input signal (Digit 2).

WARNING: Any other I/Os are **NOT** isolated from signal. Options Q-T (Digits 2 & 3) could have lethal potentials!

Options 1 & 8 are non-isolated from the signal (most economical) and cause no internal ground loop, however, your external wiring might.

Options 2, 5 & 7: Offer >500 VDC/ AC isolation between power input and all other I/O. Additionally, Serial I/O Options 2-5 (Digit 5) are isolated from all other internal and external circuits by >500VDC/RMS.

LBD SERIES continued

Serial I/O (5th Digit):

Option 1: Parasitic RS232E. Only for powerless models (option 0 on 3rd digit). **WARNING:** No Isolation From Signal.

Option 2: Isolated RS2323: 1200-19.2kb, all ASCII (8N1) open protocol "DB9"

Option 3: Isolated RS485: 1200-19.2kb, all ASCII (8N1) open protocol screw terminal connector.

Option 4: Isolated USB: 1200-19.2kb, all ASCII (8N1) open protocol "USB Type B."

Option 5: Ethernet: Fully compliant 10 baseT and RJ45 connector.

Any terminal program (Hyperterminal, Procomm, Kermit) will work with OTEK's serial com. ports. For USB download our Driver at: www.otekcorp.com Contact OTEK for availability.

Control & Power Out (Digit 6):

Option 1: Relays (4): Standard outputs are rated at 1 amp at 120 VAC/30 VDC resistive load. Also applies to option 5 & 7 (Relays). Power required by each relay is 200 mW (40mA@5VDC) x 4=800 mW. (Contact OTEK for 10 A contacts).

Option 2: Open Collector Transistors (O.C.T):

Four O.C.T are included and all are common emitter (sinking) to digital ground. The 5 VDC internal power is available. Maximum current allowed per O.C.T. (From the internal 5 VDC) is 20mA/O.C.T. if external VCC is used, the maximum VCE is 30 VDC and 30 mA per O.C.T. Switching time is under 300ms.

Option 3: Isolated 4-20 mA (Re-transmission): (Must include serial I/O options 1-5 Digit 5)

This option is offset & scaled via the serial port (digit 5) and can be configured for 4-20, 0-20 or 0-24 mA or 0-5 VDC via internal jumpers (standard is 4-20 mA). This option requires under 200 mA@5VDC internal power. Accuracy & linearity is +/- .1% of setting and can drive up to 1K ohms load. Also see Option B.

Option 5-8: Combinations of Option 1-4.

Don't forget to add all power requirements of each option desired. Worst case: 2 watts.

Range/Calibration (9th Digit):

0-100% and 0-1,000 counts, or use #9 and specify (configurable).

Option 4: Isolated 30 VDC Output

You can use it to excite your transmitter at up to 25mA. It consumes under one (1) watt at full load.

LBD TYPICAL CONNECTIONS

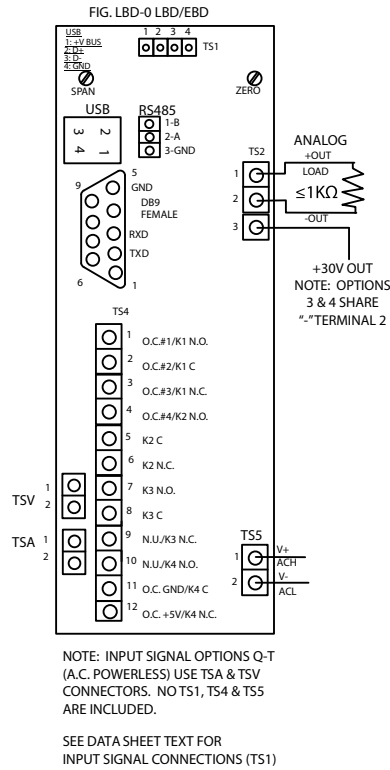

LBD MECHANICAL INFORMATION

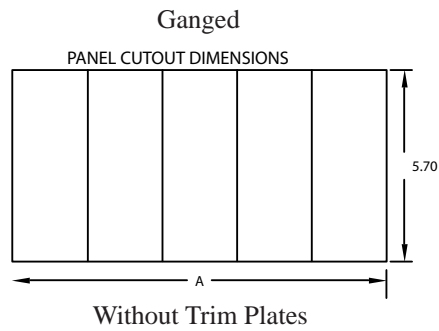
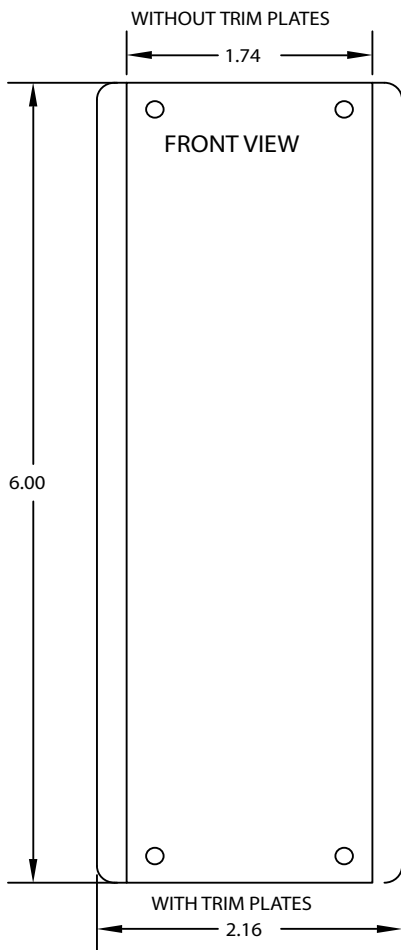

DIMENSION "A"	+0.03 -0.00	+0.76 -0.00
# UNITS	INCHES	mm
1	1.70	44.00
2	3.40	87.00
3	5.10	130.00
4	6.80	173.00
5	8.50	216.00

Plastic Trim Plates P/N 50-LBD-2
Metal Trim Plates P/N 50-119-2

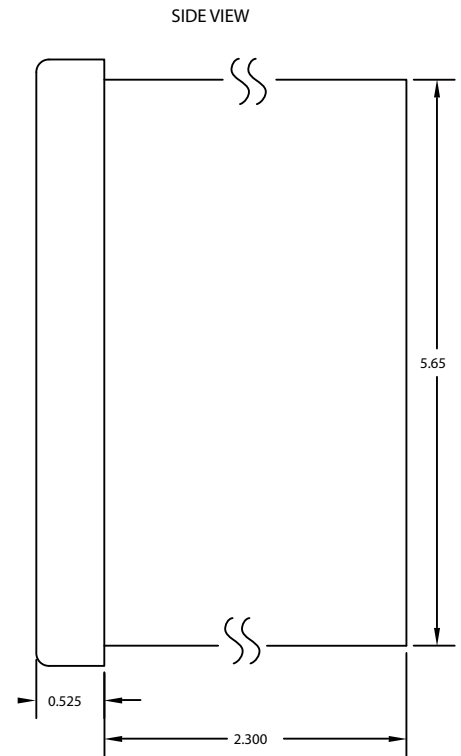

LBD SERIES PRELIMINARY ORDERING INFORMATION

4-16-13

NOTES: Please READ BEFORE building part number:

1. If digit 2 is option 0 or 1, digit 3 must be option 0, digit 5 must be option 1 and digit 6 must be option 0.
2. If digit 2 is option Q-T, then digit 3 must be option 0, digit 5 may be option 2-5 and digit 6 must be 0.
3. See notes at bottom of page.



Model: LBD-		1	2	3	4	5	6	7	8	9
		<input type="checkbox"/>	<input type="checkbox"/>	<input type="checkbox"/>	<input type="checkbox"/>	<input type="checkbox"/>	<input type="checkbox"/>	<input type="checkbox"/>	<input type="checkbox"/>	<input type="checkbox"/>
GRADE (4)										
I	Industrial								
M	Mil-Spec								
N	Nuclear (Contact OTEK)								
S	Intrinsically Safe								
9	Custom (Contact OTEK)								
F.S. INPUT SIGNAL/Z in (1,2,5,9)										
0	4-20mA Loop Powered								
1	4-30VDC Signal Powered								
2	4-20mA External Powered								
3	200mVDC/1M Ohms								
4	500 VDC/1M Ohms								
52mADC/100 Ohms								
6	200mADC/1 Ohms								
7	200mVRMS/1M Ohms								
8	500VRMS/1M Ohms								
9	Custom (Contact OTEK)								
A2mARMS/100 Ohms								
B5ARMS/0.05 Ohms								
C	Strain Gage<1000 Ohms								
D	Strain Gage>1000 Ohms								
E	2, 3 or 4 Wires RTD PT100 (100 Ohms)								
F	2, 3, or 4 Wires RTD PT1000 (1K Ohms)								
G	Frequency 40-20 KHz								
H	Frequency 50-440HZ Line								
J	TC Type J								
K	TC Type K								
L	% RH (Specify Sensor)								
M	pH (0-14.00)								
N	ORP (0-2000 mV)								
P	High Speed Peak & Hold, 2 V								
Q	VAC Signal Powered (P.T.)								
R	AAC Signal Powered (5A C.T.)								
S	50-440 Hertz Signal Powered (P.T.)								
T	Watts AC Signal Powered (P.T. & C.T.)								
U	None (Remote Display/Control)								
POWER INPUT (1,2)										
0	Signal/Loop Powered								
1	Non-Isolated 5VDC								
2	Isolated 5VDC								
3	Isolated 10-32VDC								
5	Isolated 90-265VAC								
7	Isolated 7-32VDC								
8	Non-Isolated 7-32VDC								
9	Custom (Contact OTEK)								
RANGE/CALIBRATION (6)										
0	Standard								
9	Custom (Contact OTEK)								
SCALE PLATE										
0	Standard (0-100%)								
9	Custom (Contact OTEK)								
HOUSING										
0	Plastic Without Trim Plates								
1	Plastic With Trim Plates								
2	Metal Without Trim Plates								
3	Metal With Trim Plates								
CONTROL OUTPUTS (1,2,8)										
0	None								
1	(200mA) Relays (4 ea.)								
2	(20mA) Open Collector Xtrs. (4 ea.)								
3	(200mA) Retransmission (4-20mA)								
4	(200mA) 30VDC For Transmitter								
5	(400mA) Relays & 4-20mA Out								
6	(220mA) O.C.T. & 4-20mA								
7	(400mA) Relays & 30VDC Out								
8	(220mA) O.C.T. & 30VDC Out								
9	Custom (Contact OTEK)								
SERIAL I/O (1,2)										
1	Non-Isolated Parasitic RS232E								
2	Isolated (10mA) Standard RS232D								
3	Isolated (10mA) RS485								
4	Isolated (10mA) USB								
5	(PENDING).....Isolated (200mA) Ethernet								
9	Custom (Contact OTEK)								
TRICOLOR (RGY) BACKLIGHT (7)										
0	None								
1	Included								

NOTES (Continued):

4. Contact OTEK for other grades and for M, N & S Versions. Otek will build to certain nuclear or MIL-standards but testing and confirmation of compliance, if required, will need to be done by a third party and at customer's expense. Intrinsically safe version is compliant by design only. No certificate is available until further notice.
5. See description on data sheet. Use option 9 and specify for ranges not listed.
6. Standard configuration is: 0-100% and 0-1,000 counts for F.S. range. Colors are red: <10>90%; orange: <20>80%; green: >20<80%. Field configurable. Specify yours at time of ordering.
7. Standard viewing angle: ±45°.
8. Power for transmitter is **isolated** (options 4, 7 or 8). ()=current required @ 5VDC.
9. Specify sensor manufacturer and type for pH and % RH.

